



NI 43-101 TECHNICAL REPORT

HIGGINSVILLE - LAKEWOOD OPERATION EASTERN GOLDFIELDS, WESTERN AUSTRALIA

Report Date: January 4, 2024

Effective Date: September 30, 2023

Prepared for:

Karora Resources Inc

141 Adelaide Street West, Suite 1608

Toronto, Ontario, Canada

Qualified Persons:

Stephen Devlin, FAusIMM - Karora Resources Pty Ltd (Australia) ●
Peter Ganza, MAusIMM (CP) – Karora Resources Pty Ltd (Australia) ●
Ian Glacken, Sc (Hons) (Geology), MSc(Mining Geology), DIC, MSc (Geostatistics), Grad Dip
Computing, FAusIMM(CP), FAIG, MIMMM, CEng – Snowden Optiro ●

DATE AND SIGNATURE PAGE

Technical Report Title: NI 43-101 Technical Report
Higginsville-Lakewood Operation
Eastern Goldfields, Western Australia

Technical Report Date: January 4, 2024

Effective Date: September 30, 2023

Signed by:



January 4, 2024

Stephen Devlin, FAusIMM



January 4, 2024

Peter Ganza, MAusIMM (CP)

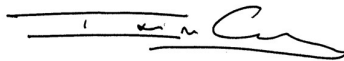

January 4, 2024

Ian Glacken, FAusIMM(CP), FAIG, MIMMM, CEng

TABLE OF CONTENTS

DATE AND SIGNATURE PAGE	i
TABLE OF CONTENTS	ii
LIST OF TABLES	viii
LIST OF FIGURES	xiii
1 SUMMARY	1
1.1 INTRODUCTION	1
1.2 PROPERTY DESCRIPTION AND OWNERSHIP	1
1.3 HIGGINSVILLE - GEOLOGY AND MINERALIZATION	1
1.4 MINERAL RESOURCE ESTIMATES	2
1.5 MINERAL RESERVE ESTIMATES	2
1.6 OPERATIONS AND DEVELOPMENT	3
1.7 ENVIRONMENTAL STUDIES, PERMITTING, AND SOCIAL OR COMMUNITY IMPACT	3
1.8 CAPITAL AND OPERATING COSTS	4
1.8.1 Underground	4
1.8.2 Open Pit Mining	4
1.8.3 Processing and Tailings Storage Facilities	4
1.8.4 General and Administration	4
1.8.5 Royalties.....	4
1.8.6 Closure Costs.....	5
1.9 CONCLUSION AND RECOMMENDATIONS	5
2 INTRODUCTION	6
2.1 REPORT CONTRIBUTORS AND QUALIFIED PERSON.....	6
3 RELIANCE ON OTHER EXPERTS	8
4 PROPERTY DESCRIPTION AND LOCATION	9
4.1 LOCATION	9
4.2 MINERAL TENURE	9
4.2.1 Higginsville	9
4.3 UNDERLYING AGREEMENTS.....	20
4.3.1 Lithium Rights Agreement – Liontown Resources Limited	20
4.3.2 Lithium Rights Agreement – Kali Metals Limited	20
4.3.3 Nickel Rights Agreement – S2 Resources Limited	20
4.3.4 Nickel Rights Agreement – WA Nickel Pty Ltd	20
4.3.5 Royalties.....	20
4.3.6 Joint Ventures.....	20
4.4 ENVIRONMENTAL CONSIDERATIONS	20
4.4.1 Higginsville Gold Operations.....	21
4.4.2 Lakewood Operations.....	21

4.5	PERMITS AND AUTHORISATION	21
4.5.1	Active Mining Operations	21
4.5.2	Higginsville Mill	21
4.5.3	Lakewood Mill	22
4.6	MINING RIGHTS IN WESTERN AUSTRALIA	22
4.6.1	Mining Tenements	22
4.6.2	Native Title Act 1993	22
4.6.3	Aboriginal Heritage Act 1972	23
5	ACCESSIBILITY, LOCAL RESOURCES, INFRASTRUCTURE, CLIMATE AND PHYSIOGRAPHY	25
5.1	ACCESSIBILITY	25
5.1.1	Higginsville Mill	25
5.1.2	Lakewood Mill	25
5.2	LOCAL RESOURCES AND INFRASTRUCTURE	26
5.3	CLIMATE	26
5.4	PHYSIOGRAPHY	26
5.4.1	Higginsville Mill	26
5.4.2	Lakewood Operations	27
6	HISTORY	28
6.1	PRE-WESTGOLD	28
6.2	WESTGOLD RESOURCES	29
6.3	KARORA RESOURCES	31
7	GEOLOGICAL SETTING AND MINERALISATION	33
7.1	REGIONAL GEOLOGY	33
7.2	MINERALISATION (BY GEOLOGICAL DOMAIN)	35
7.2.1	Trident Line-of-Lode	35
7.2.2	Chalice	37
7.2.3	Lake Cowan	38
7.2.4	Southern Palaeochannels	39
7.2.5	Mt Henry	40
7.2.6	Polar Bear Group	43
7.2.7	Spargos Project Area	45
8	DEPOSIT TYPES	47
8.1	GREENSTONE-HOSTED QUARTZ-CARBONATE VEIN GOLD DEPOSITS	47
8.1.1	Diagnostic Features	48
8.1.2	Grade and Tonnage Characteristics	48
8.2	SEDIMENT-HOSTED PALAEOCHANNEL DEPOSITS	48
9	EXPLORATION	50
9.1	SUMMARY	50

9.2	GEOPHYSICAL SURVEYS	50
9.3	SOIL AND ROCK CHIP SAMPLING	53
9.4	3D STRUCTURAL MODELLING (MODEL EARTH).....	55
9.4.1	Spargos Reward.....	55
9.4.2	Trident Line-of-Lode	56
9.5	INTEGRATED 3D REGIONAL GEOLOGICAL MODEL TRIDENT NORTH (CSA GLOBAL) 57	
10	DRILLING.....	59
10.1	DRILLING SUMMARY	59
10.2	DRILLING MAPS	61
10.3	RESULTS	62
10.3.1	Lake Cowan and Sleuth Trend	62
10.3.2	Spargos Reward.....	65
10.3.3	Norcott.....	67
11	SAMPLE PREPARATION, ANALYSIS AND SECURITY.....	71
11.1	SAMPLE COLLECTION AND SECURITY	71
11.1.1	Aircore (AC).....	71
11.1.2	Reverse Circulation Drilling (RC)	71
11.1.3	Diamond Drilling (DD).....	72
11.1.4	Sample Security	72
11.1.5	Prospect Sample Summary	72
11.2	LABORATORY SAMPLE PREPARATION, ASSAYING AND ANALYTICAL PROCEDURES.....	75
11.2.1	Fire Assay	76
11.2.2	Recovery Techniques	78
11.2.3	Aqua Regia.....	78
11.3	QUALITY CONTROL PROCEDURES AND QUALITY ASSURANCE	79
11.3.1	Quality Control Procedures.....	79
11.3.2	Quality Control Analysis.....	80
11.3.3	Database Integrity	90
11.4	SAMPLE PREPARATION, SECURITY AND ANALYTICAL PROCEDURES SUMMARY	90
12	DATA VERIFICATION.....	91
13	MINERAL PROCESSING AND METALLURGICAL TESTING.....	92
13.1	GOLD PROCESSING	92
14	MINERAL RESOURCE ESTIMATES	93
14.1	SUMMARY	93
14.2	HIGGINSVILLE GOLD OPERATIONS	95
14.3	HIGGINSVILLE CENTRAL.....	96
14.3.1	Trident	97

14.3.2 Eundynie Group.....	110
14.3.3 Fairplay North.....	116
14.3.4 Fairplay Main.....	123
14.3.5 Two Boys.....	130
14.3.6 Pioneer.....	138
14.3.7 Mitchell Group.....	147
14.3.8 Pluto.....	154
14.3.9 Vine.....	160
14.4 HIGGINSVILLE GREATER.....	166
14.4.1 Spargos.....	166
14.4.2 Chalice.....	175
14.4.3 HGO Greater Paleochannels.....	181
14.4.4 Musket.....	194
14.4.5 Lake Cowan Deposits.....	206
14.4.6 Mt Henry.....	216
14.5 STOCKPILES.....	248
15 MINERAL RESERVE ESTIMATES.....	249
15.1 INTRODUCTION.....	249
15.2 HIGGINSVILLE CENTRAL.....	250
15.2.1 Trident Underground.....	250
15.2.2 Open Pits.....	252
15.3 HIGGINSVILLE GREATER.....	254
15.3.1 Chalice Underground.....	254
15.3.2 Spargos Underground.....	258
15.3.3 Mt Henry Project.....	260
15.3.4 Other Open Pits.....	262
15.4 STOCKPILES.....	264
16 MINING METHODS.....	266
16.1 HIGGINSVILLE CENTRAL.....	266
16.1.1 Trident Underground.....	266
16.1.2 Open Pits.....	276
16.2 HIGGINSVILLE GREATER.....	282
16.2.1 Chalice Underground.....	282
16.2.2 Spargos Underground.....	292
16.2.3 Mt Henry Project.....	300
16.2.4 Other Open Pits.....	309
17 PROCESSING.....	316

17.1	HIGGINSVILLE MILL	316
17.1.1	Process Description.....	317
17.1.2	Plant Performance	319
17.2	LAKEWOOD MILL	321
17.2.1	Process Description.....	321
17.2.2	Plant Performance	323
18	PROJECT INFRASTRUCTURE	326
18.1	HIGGINSVILLE MILL	326
18.1.1	Utilities.....	326
18.1.2	Disposal and Drainage	327
18.1.3	Buildings and Facilities	327
18.1.4	Communications.....	329
18.1.5	Tailings Storage.....	329
18.2	LAKEWOOD MILL	329
18.2.1	Utilities.....	329
18.2.2	Tailings Storage.....	329
19	MARKET STUDIES AND CONTRACTS	330
19.1	GOLD MARKET STUDIES.....	330
19.2	CONTRACTS.....	331
20	ENVIRONMENTAL STUDIES, PERMITTING, AND SOCIAL OR COMMUNITY IMPACT	332
20.1	HIGGINSVILLE GOLD OPERATIONS.....	332
20.1.1	Environmental Studies.....	332
20.1.2	Required Permits and Status	332
20.1.3	Environmental Aspects, Impacts and Management	334
20.1.4	Mining Rehabilitation Fund	335
20.1.5	Social and Community.....	335
20.2	LAKEWOOD OPERATIONS.....	335
20.2.1	Environmental Studies.....	335
20.2.2	Hydrology	336
20.2.3	Required Permits and Status	337
20.2.4	Environmental Aspects, Impacts and Management	339
20.2.5	Mining Rehabilitation Fund	339
20.2.6	Social and Community.....	339
21	CAPITAL AND OPERATING COSTS.....	340
21.1	HIGGINSVILLE CENTRAL.....	340
21.1.1	Trident Underground.....	340
21.1.2	Open Pits.....	341

21.2 HIGGINSVILLE GREATER	342
21.2.1 Chalice Underground.....	342
21.2.2 Spargos Underground	343
21.2.3 Mt Henry Project.....	344
21.2.4 Other Open Pits.....	345
22 ECONOMIC ANALYSIS	347
22.1 CASH FLOW ANALYSIS	347
22.2 COMMENTS ON SECTION 22	347
23 ADJACENT PROPERTIES.....	348
23.1 ST IVES	348
23.2 NORSEMAN	348
24 OTHER RELEVANT DATA AND INFORMATION	350
24.1 GOLD EXPLORATION POTENTIAL.....	350
25 INTERPRETATION AND CONCLUSIONS.....	353
25.1 MINERAL RESOURCES	353
25.2 MINERAL RESERVES.....	354
25.3 MINERAL PROCESSING	354
25.4 MINING.....	354
25.5 ENVIRONMENTAL	354
25.6 CAPITAL REQUIREMENTS	355
26 RECOMMENDATIONS.....	356
27 REFERENCES	357
APPENDIX 1 DEFINITIONS	361

LIST OF TABLES

Table 1-1 Higginsville Gold Mineral Resources at September 30, 2023	2
Table 1-2 Higginsville Gold Mineral Reserves at September 30, 2023	2
Table 2-1 Persons who prepared or contributed to this Technical Report.....	7
Table 3-1 Other parties relied upon to provide technical content to this Technical Report.....	8
Table 4-1 HGO Mineral Tenure Information	11
Table 6-1 HGO Historical Gold Mineral Resources as at June 30, 2018.	30
Table 6-2 HGO Historical Gold Mineral Reserves as at June 30, 2018	30
Table 6-3 Higginsville Gold Mineral Resources as of September 30, 2020	31
Table 6-4 Higginsville Gold Mineral Reserves as of September 30, 2020	31
Table 6-5 Higginsville Gold Mineral Resources as of January 31, 2022	31
Table 9-1 Description of assay methods used and number of related samples	53
Table 10-1 Higginsville drill hole database– number of holes and metres drilled between October 1, 2020 and July 2, 2023	59
Table 10-2 Drilling by prospect and hole type from October 1, 2020 to July 2, 2023	59
Table 10-3 Drilling highlights from Lake Cowan, 2021.....	62
Table 10-4 Spargos significant (g X m) intercepts, Phase 1 Resource Definition drilling Nov. – Dec. 2020	65
Table 10-5 Significant AC intercepts 2021	68
Table 11-1 Sample count for each Higginsville prospect by sample type, laboratory and method	73
Table 11-2 Independent commercial laboratories.....	75
Table 11-3 Summary of laboratories used and assay method.....	76
Table 11-4 Karora-inserted CRM and blank standards for gold for the reporting period to July 2023.....	79
Table 11-5 Laboratory summary for Au fire assay October 1, 2020 to July 2, 2023.....	80
Table 11-6 Karora submitted Au blanks for fire assay all laboratories, October 1, 2020 to July 2, 2023.....	82
Table 11-7 Karora submitted Au Standards for fire assay AAS Bureau Veritas Kalgoorlie and Perth, October 1, 2020 to July 2, 2023.....	82
Table 11-8 Karora submitted Au Standards for fire assay 50g ALS Perth and Intertek Perth, October 1, 2020 to July 2, 2023	85
Table 11-9 Karora submitted Au Standards for fire assay ICP-OES ALS Perth and Bureau Veritas Perth, October 1, 2020 to July 2, 2023.....	87
Table 14-1 Karora Consolidated Higginsville Gold Mineral Resources as at September 30, 2023	93
Table 14-2 Top-cuts applied to each domain.....	102
Table 14-3 Bulk density summary of test results by rock type and area	103
Table 14-4 Trident variogram orientations and model parameters.....	104
Table 14-5 Trident block model extents – Westgold Vulcan Model March 2017	105
Table 14-6 Reconciliation data for CY 2016	107
Table 14-7 The Trident Mineral Resource by area	109
Table 14-8 Database export – May 2022	110
Table 14-9 Statistical summary Mouse Hollow – 2022 Model.....	114
Table 14-10 Assumed bulk densities.....	114
Table 14-11 Mouse Hollow Deposit September 2023 Mineral Resource Estimate	116
Table 14-12 Statistics and top-cuts applied to Fairplay North domains (Au ppm).....	119
Table 14-13 Densities applied for the Fairplay North open pit model.....	119

Table 14-14 Variogram model parameters for the Fairplay North estimation	120
Table 14-15 Fairplay North Deposit September 2023 Mineral Resource Estimate	122
Table 14-16 Historical production of the Fairplay Group deposits from 1980 to 2017	124
Table 14-17 Bulk density values applied to Fairplay Main Model.....	127
Table 14-18 Variogram model parameters for the Fairplay Main	128
Table 14-19 Fairplay -Two Boys block model extents and cell sizes	128
Table 14-20 Fairplay Main Open Pit Mineral Resource	129
Table 14-21 Bulk density values assigned in the block model	131
Table 14-22 Summary statistics for Two Boys composites.....	134
Table 14-23 Variogram parameters summary for Au.....	135
Table 14-24 Two Boys Gold Deposit September 2023 Mineral Resource Estimate.....	137
Table 14-25 Pioneer drill hole summary	139
Table 14-26 Drill holes excluded from the Resource Estimate	139
Table 14-27 Pioneer Deposit summary statistics.....	142
Table 14-28 Density values applied at Pioneer	143
Table 14-29 Pioneer Variogram parameters summary	143
Table 14-30 Pioneer Depleted Mineral Resource using 0.5 g/t Au cut-off.....	146
Table 14-31 Mitchell Deposit – data export summary.....	149
Table 14-32 Density values used in Mitchell model.....	150
Table 14-33 Summary statistics for Mitchell Flat lodes.....	151
Table 14-34 Summary statistics for Mitchell Steep lodes	151
Table 14-35 Variogram parameters for Mitchell grouped domains	152
Table 14-36 Mitchell Depleted Mineral Resource using 0.5 g/t Au cut-off.....	154
Table 14-37 Density values assigned in the Pluto model	156
Table 14-38 Pluto Depleted Mineral Resource using 0.5 g/t Au cut-off.....	159
Table 14-39 Line-of-Lode density values used for Vine.....	162
Table 14-40 Block model parameters for Vine.....	163
Table 14-41 Estimation strategy for Au grade interpolation	163
Table 14-42 Vine Depleted Mineral Resource using 0.5 g/t Au cut-off.....	165
Table 14-43 Spargos drill hole summary	168
Table 14-44 Spargos gold deposit summary statistics.....	171
Table 14-45 Variogram parameters summary	172
Table 14-46 Spargos Depleted Mineral Resource using 1.6 g/t Au cut-off.....	175
Table 14-47 Top-cut summary	178
Table 14-48 Bulk densities used in the Chalice model	178
Table 14-49 Variogram model parameters for the Chalice estimation	179
Table 14-50 Chalice Depleted Mineral Resource using 1.3 g/t Au cut-off.....	181
Table 14-51 Summary of drill hole data used in compilation of Nanook mineral resource estimate	182
Table 14-52 Summary statistics of 4 m composites of uncut gold grade (g/t)	183
Table 14-53 Revised statistics of the downhole composites with grade capping applied.....	184
Table 14-54 Back-transformed variogram model parameters - Domain 100.....	185
Table 14-55 Nanook block model definition parameters.....	186
Table 14-56 Estimation parameters for gold estimation.....	186
Table 14-57 Nanook Mineral Resource using 0.5 g/t Au cut-off.....	187
Table 14-58 Drill hole summary at the Wills Deposit	188
Table 14-59 Summary statistics of all interpreted domains – Wills Deposit	190
Table 14-60 Revised statistics of the downhole composites with grade capping applied.....	190
Table 14-61 Density value used in the block model.....	191

Table 14-62 Variogram parameters for Domain 101.....	191
Table 14-63 Wills block model definition	192
Table 14-64 Estimation parameters for Domains 101 and 1022.....	192
Table 14-65 Local Au capping parameters	192
Table 14-66 Wills Mineral Resource using 0.5 g/t Au cut-off	194
Table 14-67 Musket data export – drill hole summary	197
Table 14-68 Musket area naming convention.....	197
Table 14-69 Summary statistics for all Musket domains.....	200
Table 14-70 Density assigned to the Musket block model.....	201
Table 14-71 Variogram parameter summary	203
Table 14-72 Musket block model summary	203
Table 14-73 Musket Mineral Resource using 0.5 g/t Au cut-off	205
Table 14-74 Top-cuts applied at Lake Cowan deposits	213
Table 14-75 Density values assigned to Lake Cowan models.....	213
Table 14-76 Lake Cowan block models – cell size summary.....	214
Table 14-77 Lake Cowan Depleted Mineral Resource using a 0.5 g/t Au cut-off	215
Table 14-78 Mt Henry Project Mineral Resource Summary as at September 30, 2023	217
Table 14-79 Selene caps (top-cuts)	224
Table 14-80 Summary of Selene variography	224
Table 14-81 Summary of Selene and North Scotia model origin and extents	225
Table 14-82 Details of Selene density assignment.....	226
Table 14-83 Selene whole-of-domain validation.....	227
Table 14-84 North Scotia cap values	231
Table 14-85 North Scotia variogram model derived from continuous lodes	232
Table 14-86 North Scotia – block model versus solid volume comparison	232
Table 14-87 North Scotia – dynamic anisotropy direction summary	233
Table 14-88 North Scotia – estimation parameter summary.....	234
Table 14-89 North Scotia – assignment of dry bulk density values.....	234
Table 14-90 North Scotia – whole-of-domain validation for selected key zones	235
Table 14-91 Abbotshall top-cuts.....	238
Table 14-92 Abbotshall variogram parameters for selected domains	239
Table 14-93 Abbotshall – block model origin and extents.....	240
Table 14-94 Abbotshall – selected whole-of-domain validation	240
Table 14-95 Mt Henry – block model extents (local grid) and block size.....	244
Table 14-96 Stockpile Mineral Resource – HGO – as at September 30, 2023	248
Table 15-1 Higginsville Gold Mineral Reserves at September 30, 2023	249
Table 15-2 Trident Gold Mineral Reserves at September 30, 2023.....	251
Table 15-3 Trident Underground Mineral Reserves – net gold price calculation	252
Table 15-4 Trident cut-off grade calculation inputs.....	252
Table 15-5 Mitchell and Pioneer Gold Mineral Reserves at September 30, 2023.....	253
Table 15-6 Mitchell and Pioneer Open Pit Mineral Reserves – net gold price calculation	254
Table 15-7 Mitchell and Pioneer Open Pit Mineral Reserves – cut-off grade calculation	254
Table 15-8 Chalice Gold Mineral Reserves at September 30, 2023	256
Table 15-9 Chalice Underground Mineral Reserves – net gold price calculation	257
Table 15-10 Chalice Underground Mineral Reserves – cut-off grade calculation inputs	257
Table 15-11 Spargos Underground Mineral Reserves at September 30, 2023.....	258
Table 15-12 Spargos Underground Mineral Reserves – net gold price calculation	259
Table 15-13 Spargos Underground Mineral Reserves – cut-off grade calculation inputs.....	260
Table 15-14 Mt Henry Project Gold Mineral Reserves at September 30, 2023.....	261

Table 15-15 Mt Henry Project Open Pit Mineral Reserves – net gold price calculation.....	262
Table 15-16 Mt Henry Group Open Pit Mineral Reserves – cut-off grade calculation	262
Table 15-17 Atreides and Musket Gold Mineral Reserves at September 30, 2023.....	263
Table 15-18 Atreides and Musket Open Pit Mineral Reserves – net gold price calculation.....	264
Table 15-19 Atreides and Musket Open Pit Mineral Reserves – cut-off grade calculation	264
Table 15-20 Stockpile Mineral Reserve – HGO – as at September 30, 2023	265
Table 16-1 Trident Principal Stress	268
Table 16-2 Trident Q' by Area	269
Table 16-3 Stope design criteria.....	271
Table 16-4 Primary underground fleet.....	274
Table 16-5 Labour estimate	274
Table 16-6 Mitchell geotechnical design criteria	277
Table 16-7 Pioneer geotechnical design criteria.....	278
Table 16-8 Pit design parameters	279
Table 16-9 Mitchell Mineral Reserves Schedule.....	280
Table 16-10 Pioneer Mineral Reserves Schedule	281
Table 16-11 Dump design criteria	281
Table 16-12 Chalice rock strength properties	284
Table 16-13 Trident Acoustic Emission Method testing results.....	284
Table 16-14 Chalice domain Q System Rock Class Rating results.....	285
Table 16-15 Design criteria	288
Table 16-16 Primary underground fleet.....	291
Table 16-17 Labour requirements	291
Table 16-18 Spargos rock defects.....	294
Table 16-19 Spargos stope design parameters.....	296
Table 16-20 Estimated dilution percentage as a function of MDW and 0.25 m HW and FW overbreak.....	296
Table 16-21 Primary underground fleet.....	299
Table 16-22 Labour estimate	300
Table 16-23 Selene and North Scotia recommended slope angles	303
Table 16-24 Mt Henry recommended slope angles	303
Table 16-25 Mt Henry Project mine design parameters.....	304
Table 16-26 Mt Henry Project - Mineral Reserves Schedule	308
Table 16-27 Musket recommended pit and slope design parameters.....	311
Table 16-28 Lake Cowan (Atriedies) recommended pit and slope design parameters	311
Table 16-29 Pit design parameters	312
Table 16-30 Atreides Mineral Reserves schedule	314
Table 16-31 Musket Mineral Reserves schedule.....	314
Table 16-32 Dump design criteria	315
Table 19-1 Gold market supply – demand balance	330
Table 20-1 Summary HGO key licence and approvals.....	333
Table 21-1 Initial project capital cost	340
Table 21-2 Sustaining capital cost.....	340
Table 21-3 Site operating costs.....	341
Table 21-4 HGO Central operating costs	341
Table 21-5 Initial project capital cost	342
Table 21-6 Sustaining capital cost.....	342
Table 21-7 Operating costs.....	342
Table 21-8 Initial project capital cost	343

Table 21-9 Sustaining capital cost.....	343
Table 21-10 Operating costs	344
Table 21-11 Mt Henry Project mining costs.....	344
Table 21-12 Mt Henry Project costs	345
Table 21-13 HGO Central operating costs	345

LIST OF FIGURES

Figure 4-1 Higginsville-Lakewood Operations location map	10
Figure 4-2 Higginsville-Lakewood Operations map showing location of mineral tenure	17
Figure 4-3 Higginsville Mill tenure map.....	18
Figure 4-4 Lakewood Mill tenure map	19
Figure 5-1 Higginsville Mill access - oblique aerial view	25
Figure 6-1 Higginsville Mill (2008)	29
Figure 6-2 Lakewood Mill (2022).....	32
Figure 7-1 Greenstone belts within the Yilgarn Craton	33
Figure 7-2 Stratigraphic relationships of the principal mafic-ultramafic units of the Kalgoorlie Terrane	34
Figure 7-3 Deposits along the Trident Line-of-Lode.....	36
Figure 7-4 Simplified Geology of the Chalice Pit (left) Plan View, (right) Section view looking north	37
Figure 7-5 Deposits within the Lake Cowan Project	38
Figure 7-6 Location of the Challenge/Swordsman and Mitchell Palaeochannels	39
Figure 7-7 Geology of the Mt Henry area	41
Figure 7-8 Stratigraphic diagram of the Mt Henry area and location of various deposits	42
Figure 7-9 Geology of the Polar Bear region	44
Figure 7-10 Regional Geology highlighting major structures and gold deposits.....	46
Figure 8-1 Inferred crustal levels of gold deposition showing the different types of gold deposits and the inferred deposit clan	47
Figure 8-2 Schematic geology of the Southern Paleochannel area showing the mineralisation position	49
Figure 9-1 Locations of geophysical surveys by Atlas Geophysics 2020	51
Figure 9-2 Processed Abbotshall gravity survey.....	52
Figure 9-3 Processed Higginsville gravity survey	52
Figure 9-4 Processed Lefroy gravity survey	53
Figure 9-5 Locations of all surface samples collected on Karora tenements	54
Figure 9-6 Model Earth's primary control on the plunge of orebodies at Spargos Reward is moderate (40°–55°) NNE-plunging folding and the intersection of associated S1 (pervasive) foliation with bedding or lithology boundaries	55
Figure 9-7 Model Earth overview geology for Line-of-Lode with focus on the fractionation of mafics being significant.....	57
Figure 9-8 Example of litho geochemistry evaluation in general showing a good correlation between logged/modelled lithology and geochemistry.....	58
Figure 10-1 Distribution of drilling between October 1, 2020 and July 2, 2023 within the Higginsville tenement.....	61
Figure 10-2 Plan view of geochemical anomalous of the Principal Component (PC) 2 Score As-Ag-Pb-Sb-Au based on bottom of hole aircore samples which defines the Sleuth Trend. Element association interpreted to represent primary gold mineralization	63
Figure 10-3 Max g/t Au in drill holes overlaid on satellite image of Lake Cowan highlighting selected significant intersections from recently completed drilling and interpreted structures....	64
Figure 10-4 Drill section of Spargos Reward showing most recent results and best intercepts (estimated true widths). Source (Karora, 2023c).....	66
Figure 10-5 Norcott Project - 1VD magnetic image highlighting drilling max Au	69

Figure 10-6 Plan view of 2021 regional AC collars (white triangles) at Norcott, and ioGAS gridded Au/Ag/Sb trends. White zones are priority infill targets, adjacent to interpreted NE fault jog and centered upon chemical sediments.	70
Figure 11-1 Representative fire assay sample flow chart Bureau Veritas Kalgoorlie	77
Figure 11-2 Standards – sRPD box and whisker plot Au fire assay AAS Bureau Veritas Kalgoorlie	80
Figure 11-3 Standards – sRPD box and whisker plot Au fire assay AAS Bureau Veritas Perth .	81
Figure 11-4 Standards – sRPD box and whisker plot Au fire assay 50g AAS ALS Perth and Intertek Perth	81
Figure 11-5 Standards – sRPD box and whisker plot Au fire assay ICP-OES ALS Perth and Bureau Veritas Perth.....	81
Figure 11-6 Karora submitted Au blanks for fire assay all laboratories, October 1, 2020 to July 2, 2023.....	82
Figure 11-7 Standard G315-1: outliers included	83
Figure 11-8 Standard G901-5: outliers included	83
Figure 11-9 Standard G905-7: outliers included	84
Figure 11-10 Standard G910-2: outliers included	84
Figure 11-11 Standard G914-7: outliers included	84
Figure 11-12 Standard G916-6: outliers included	85
Figure 11-13 Standard G313-8: outliers included	85
Figure 11-14 Standard G314-3: outliers included	86
Figure 11-15 Standard G314-9: outliers included	86
Figure 11-16 Standard G915-6: outliers included	86
Figure 11-17 Standard G916-6: outliers included	87
Figure 11-18 Standard G313-8: outliers included	87
Figure 11-19 Standard G314-9: outliers included	88
Figure 11-20 Standard G909-6: outliers included	88
Figure 11-21 Scatter plot comparing field duplicates Au fire assay – log plot	89
Figure 11-22 Scatter plot comparing laboratory pulp checks for Au fire assay – log plot	89
Figure 14-1 Location of Karora Mineral Resources and Mineral Reserves effective September 30, 2023. Plan also depicts Higginsville Central and Higginsville Greater	95
Figure 14-2 Location of deposits of the HGO Central Mineral Resources.....	96
Figure 14-3 Trident location map.....	97
Figure 14-4 Trident domains – long-section looking west.....	99
Figure 14-5 Trident lodes – long-section looking west.....	100
Figure 14-6 Artemis main wireframe (top) and sub-domaining (bottom) – long-section view looking west	101
Figure 14-7 Trident model in situ blocks >1.3 g/t Au – long-section looking west	106
Figure 14-8 Trident block model coloured by resource classification – long-section looking west	108
Figure 14-9 Karora sterilisation shapes shown in cyan colour – longsection looking west.....	109
Figure 14-10 Drilling at Hidden Secret/Mouse Hollow – database export May 2022.....	111
Figure 14-11 Mineralisation wireframes interpreted in 2022 with drilling and final July 2023 Mouse Hollow Pit	112
Figure 14-12 Mineralised wireframe interpretation 2022 and Mouse Hollow July 2023 EOM pit	113
Figure 14-13 Plan view of the Fairplay North gold mineralised system.....	117
Figure 14-14 Oblique view of the Fairplay North gold mineralised system looking NNE	118
Figure 14-15 Fairplay North variogram – Domain 1001.....	120

Figure 14-16 Fairplay North variogram – oxide Domains 1 to 3 combined	121
Figure 14-17 Location of the HGO Central Fairplay group.....	123
Figure 14-18 Schematic plan of the Line-of-Lode system (Source: Westgold (2018))	125
Figure 14-19 Long-section view of the main mineralisation envelopes (looking west)	126
Figure 14-20 Log histogram and Log probability plot for Fairplay (Main) Domain 101	127
Figure 14-21 Plan view of Two Boys mineralisation interpretation.....	132
Figure 14-22 Isometric view of Two Boys mineralisation interpretation looking southwest.....	133
Figure 14-23 Histogram and log probability plots for Main Domain 1	134
Figure 14-24 Variogram models for Domain 1	135
Figure 14-25 Two Boys model classification – isometric view looking southwest	137
Figure 14-26 Long-section view looking west of Pioneer mineralisation interpretation – main lodes labelled	140
Figure 14-27 Plan view of Pioneer mineralisation interpretation – main lodes labelled	141
Figure 14-28 Variogram models for Domain 1	144
Figure 14-29 Pioneer block model coloured by resource classification – isometric view looking WNW	146
Figure 14-30 Southern Paleochannel Deposits location plan	148
Figure 14-31 Log histogram and log probability plots for Domain 105	152
Figure 14-32 Pluto – oblique view (looking ENE) of Au grades – drilling vs block model	155
Figure 14-33 Challenge/Pluto location plan.....	157
Figure 14-34 Vine and Fairplay group locations, within Higginsville Central area	161
Figure 14-35 Example of structural data used to guide flat lying lode interpretations.....	162
Figure 14-36 Oblique view – looking NE – of Vine block model colour-coded by gold grade ...	164
Figure 14-37 Completed Spargos open pit and interpreted domains – long-section looking west	167
Figure 14-38 Spargos mineralisation and completed open pit - section view looking north.....	169
Figure 14-39 Spargos mineralisation and completed open pit – long-section view looking west	170
Figure 14-40 Variogram models for Domain 1	172
Figure 14-41 Spargos block model coloured by resource classification – long-section looking west	174
Figure 14-42 Chalice mineralised domains – long-section looking west	177
Figure 14-43 Chalice block model coloured by classification (red=Measured, green=Indicated, blue=Inferred, cyan=mineral potential)	180
Figure 14-44 Nanook deposit drill hole plan highlighting mineralised zone	182
Figure 14-45 Section 6,471,300 mN showing mineralisation domain	183
Figure 14-46 Log histogram of uncut gold grade - Domain 100	184
Figure 14-47 Variogram model – Domain 100.....	185
Figure 14-48 Plan view of geological and mineralisation interpretation of Wills paleochannel deposit	189
Figure 14-49 Histogram for Domain 101 (left) and Domain 1022 (right)	190
Figure 14-50 Downhole variogram (left) and variogram model for Domain 101 (right).....	191
Figure 14-51 Plan view of Wills Deposit colour coded by resource classification: green=Indicated, red=Inferred, grey=unclassified.....	193
Figure 14-52 Musket location map	195
Figure 14-53 Schematic diagram of the Musket deposit.....	196
Figure 14-54 Musket interpreted lenses	196
Figure 14-55 Location plan of mineralised interpretation at the Musket deposit.....	198
Figure 14-56 Isometric view of silica wireframe interpretation	199

Figure 14-57 Normal scores variogram for Domain 1101	202
Figure 14-58 Model volume comparison for Musket	204
Figure 14-59 Trend plots for Domain 1101	205
Figure 14-60 Lake Cowan Project area location plan	206
Figure 14-61 Flat lying mineralised shapes around the Atreides Pit area. Local section 10,420 mN ±5 m looking north	208
Figure 14-62 Josephine cross-section 11,130 mN – drilling Au grades vs mineralisation interpretation	209
Figure 14-63 Louis cross-section 9,980 mN – drilling Au grades vs mineralisation interpretation	209
Figure 14-64 Rose cross-section 9,960 mN – drilling Au grades vs mineralisation interpretation	210
Figure 14-65 Napoleon Pit dipping and vertical lodes with the December 2015 end of month survey	211
Figure 14-66 Napoleon cross-section 11,440 mN – drilling Au grades vs mineralisation interpretation	211
Figure 14-67 Generalised estimation workflow for the Mt Henry Mineral Resource estimates. 218	
Figure 14-68 Cumulative distribution plot of gold grades for raw Selene samples	219
Figure 14-69 3D view, looking northwest, showing Selene drilling and internal waste domains	220
Figure 14-70 3D view, looking southwest, showing the existing BOCO surface and the model estimation area (in yellow).....	220
Figure 14-71 Oblique view, looking NNW, showing local modifications to the weathering surface in the Selene/North Scotia area.....	221
Figure 14-72 Satellite image of the Selene/North Scotia area, with (right) and without (left) the transported material interpretation.....	221
Figure 14-73 Selene main mineralisation domain looking northeast.....	222
Figure 14-74 Selene footwall mineralisation domain looking northeast.....	222
Figure 14-75 Selene hangingwall mineralisation domain looking northeast.....	223
Figure 14-76 Selene South mineralisation in plan view (100 m grid squares).....	223
Figure 14-77 Gold variograms for the Selene main domain.....	225
Figure 14-78 Visual validation example for Selene block model at 6,413,145 mN.....	227
Figure 14-79 Selene main domain swath plots.....	227
Figure 14-80 North Scotia plan view showing the extended 2020 base of alluvial sediment interpretation	228
Figure 14-81 View of North Scotia looking to the northwest showing the interpreted domains and the extrapolated Selene BIF.....	229
Figure 14-82 North Scotia global gold composites for cut-off grade analysis (left) and horizontal continuity fan of an 0.3 g/t indicator (right).....	230
Figure 14-83 North Scotia broader oblique view of lodes looking in plan view.....	230
Figure 14-84 North Scotia broader oblique view looking down dip – solids coloured continuous lode (cyan) or polygonal lode (red).....	231
Figure 14-85 Long-section of North Scotia (looking east) showing mineralisation and direction of maximum continuity for variography.....	232
Figure 14-86 North Scotia block model constrained within RPEEE shell	235
Figure 14-87 North Scotia block model on section at 641,1200 mN, looking north, and informing drill holes.....	236
Figure 14-88 North Scotia block swath plot validation for Domain NSC-8	236
Figure 14-89 North Scotia block swath plot validation for Domain NSC-13	237

Figure 14-90 Abbotshall – oblique view of mineralised lodes (dipping west) and updated RPEEE shell with drill holes, looking northeast	238
Figure 14-91 Abbotshall – example of variography (Lode 1009)	239
Figure 14-92 Section view of model, drill holes and US\$1,600 RPEEE shell at Abbotshall	241
Figure 14-93 Section view of model, drill holes and US\$1,600 RPEEE shell at Abbotshall	241
Figure 14-94 Abbotshall – Domain 1009 swath plots.....	242
Figure 14-95 Mt Henry – overview of mineralised domains looking southeast – grid squares are 100 m.....	243
Figure 14-96 Mt Henry – example of modelled variograms for Lode 1101.....	244
Figure 14-97 Visual validation of Mt Henry block model against drilling (9,228.6 mN), showing existing mining shell and RPEEE shell	245
Figure 14-98 Visual validation of Mt Henry block model against drilling (9,448.6 mN), showing existing mining shell and RPEEE shell.....	246
Figure 14-99 Selene main, hangingwall and footwall (left to right) block model coloured on resource confidence with classification strings	247
Figure 14-100 Selene block model, coloured by resource category (1=Measured, 2=Indicated), within RPEEE shell (in brown).....	247
Figure 15-1 Chalice aerial view showing pit (flooded).....	255
Figure 16-1 Trident Underground Mineral Reserves shows existing pit and underground workings looking west	271
Figure 16-2 Trident Underground Mineral Reserves shows existing pit and underground workings looking North.....	272
Figure 16-3 LHOS design layout.....	272
Figure 16-4 Airleg (room and pillar) mining layout – side view.....	273
Figure 16-5 Trident Mineral Reserves Schedule	274
Figure 16-6 Oblique aerial view of Trident Portal inside Poseidon South Pit looking north.	276
Figure 16-7 Mitchell Open Pit Mineral Reserves	279
Figure 16-8 Pioneer Open Pit Mineral Reserves	280
Figure 16-9 Chalice local geology as evident in the open pit.....	286
Figure 16-10 North wall of the Chalice pit showing the three main lithological zones, granite, ultramafic and amphibolite, along with various intrusive	286
Figure 16-11 Chalice Mineral Reserves showing existing pit and workings looking west.....	289
Figure 16-12 Chalice Mineral Reserves showing existing pit and workings looking north.....	289
Figure 16-13 LHOS design layout.....	290
Figure 16-14 Chalice Underground schedule	290
Figure 16-15 Spargos Underground Mineral Reserve design with existing pit (gray) and historical workings (black) looking west.....	297
Figure 16-16 Spargos Underground Mineral Reserve design with existing pit (gray) looking north	297
Figure 16-17 Spargos mined ore tonnes and grade	298
Figure 16-18 Spargos planned lateral development per month	299
Figure 16-19 Mt Henry Group current layout.....	301
Figure 16-20 Mt Henry Mineral Reserve pit design.....	305
Figure 16-21 Mt Henry Mineral Reserve design (purple) and current pit as-built	305
Figure 16-22 North Scotia Mineral Reserves pit design.....	306
Figure 16-23 Selene Mineral Reserve pit design.....	306
Figure 16-24 Mt Henry Project – mined tonnes	307
Figure 16-25 Mt Henry Project – mined ore tonnes	308
Figure 16-26 Atreides Mineral Reserve design.....	313

Figure 16-27 Musket Mineral Reserve design 313

Figure 17-1 Higginsville process flowsheet 2020..... 316

Figure 17-2 Higginsville – process recoveries vs plant throughput 320

Figure 17-3 Higginsville – process recoveries vs head grade 320

Figure 17-4 Higginsville – head grades vs tail grades 321

Figure 17-5 Lakewood – process recoveries vs plant throughput 324

Figure 17-6 Lakewood – process recoveries vs head grade..... 324

Figure 17-7 Lakewood – head grades vs tail grades 325

Figure 18-1 HGO powerhouse 326

Figure 18-2 HGO underground workshop 327

Figure 18-3 HGO light vehicle workshops 328

Figure 18-4 Higginsville Mill and workshop/store..... 328

Figure 19-1 Gold price history and consensus forecast (US\$/oz)..... 331

Figure 23-1 Gold deposits adjacent and along strike of HGO highlighting the adjacent St Ives Gold and Norseman Gold Projects..... 349

Figure 24-1 Gold deposits adjacent and along strike of Higginsville highlighting Regional Shear Zones– 1VD aeromagnetic image 351

Figure 24-2 HGO exploration target pipeline 352

Figure 24-3 Sleuth Trend exploration targets identified by the CSA Global Study 352

Figure 25-1 Consolidated Gold Mineral Resource timeline, 2016 to 2023 353

1 SUMMARY

1.1 INTRODUCTION

This technical report (the Technical Report) titled Higginsville-Lakewood Operations Eastern Goldfields, Western Australia has been prepared by Karora Resources Inc. (Karora) following completion of the updated Mineral Resource and Mineral Reserve for Higginsville Gold Operations and supersedes the Higginsville Mineral Resources and Reserves reported in the Technical Report published by Karora on February 1 (amended February 3), 2021.

This Technical Report dated January 4, 2024 can be found on Karora's website at www.karoraresources.com and under Karora's profile at www.sedar.com.

The Report was prepared in accordance with the requirements of National Instrument 43-101 (NI 43-101), 'Standards of Disclosure for Mineral Projects', of the Canadian Securities Administrators (CSA) for lodgement on CSA's System for Electronic Document Analysis and Retrieval (SEDAR).

All amounts have been presented in Australian dollars (\$) unless otherwise indicated.

1.2 PROPERTY DESCRIPTION AND OWNERSHIP

The Higginsville-Lakewood Operations (HLO) comprises the:

- Higginsville Gold Operations (HGO) including the Higginsville Mill, 242 mineral leases (as of September 30, 2023) and underground and open pit mining operations including the Mt Henry, Spargos, Mitchell, Wills and Pioneer deposits. Karora acquired HGO on June 10, 2019. The mill is located at Higginsville, Western Australia, approximately 80 km south of the Beta Hunt Mine by road. The mill has a capacity of 1.6 Mtpa.
- The Lakewood Operations (LKO) including the Lakewood Mill and associated infrastructure. Karora acquired the 1.0 Mtpa Lakewood Mill in July 2022. The mill is located approximately 65 km north of the Beta Hunt Mine at Kalgoorlie, Western Australia.

1.3 HIGGINSVILLE - GEOLOGY AND MINERALIZATION

Higginsville is located almost entirely within the well-mineralised Archean Kalgoorlie Terrane, between the gold mining centres of Norseman and St Ives. The Archaean stratigraphy has a general northward trend comprising multiple deformed ultramafic-gabbro-basalt successions adjoined by sediments to the west and east. Shearing and faulted contacts are common. The units have been structurally repeated by east-over-west thrust faulting.

Historically, the bulk of the gold mineralisation extends along the Trident Line-of-Lode and is hosted by Poseidon Gabbro and high MgO dyke complexes. Mineralization is hosted within or marginal to quartz veining and is structurally and lithologically controlled. Higginsville is also host to significant paleochannel mineralization. Mineralized horizons comprise both placer gold, normally near the base of the channel-fill sequences, and chemically-precipitated secondary gold within the channel-fill materials and underlying saprolite. These gold concentrations commonly overlie, or are adjacent to, primary mineralized zones within Archaean bedrock.

1.4 MINERAL RESOURCE ESTIMATES

The Higginsville Mineral Resource estimate, part of HLO, is presented in Table 1-1.

Table 1-1 Higginsville Gold Mineral Resources at September 30, 2023

Sep. 2023 Gold Mineral Resource	Measured			Indicated			Measured & Indicated			Inferred		
	kt	g/t	koz	kt	g/t	koz	kt	g/t	koz	kt	g/t	koz
Higginsville Central	1,002	2.8	92	4,162	2.5	339	5,164	2.6	431	2,117	2.6	179
Higginsville Greater	11,607	1.3	476	13,173	1.5	640	24,780	1.4	1,116	4,814	1.8	273
Stockpiles	745	0.6	15	1,135	0.7	27	1,880	0.7	42	-	-	-
Total	13,355	1.4	582	18,469	1.7	1,007	31,824	1.6	1,589	6,931	2.0	452

- 1) Mineral Resources that are not Mineral Reserves do not have demonstrated economic viability. There is no certainty that all or any part of the Mineral Resources estimated will be converted into Mineral Reserves.
- 2) The Measured and Indicated Mineral Resources are inclusive of those Mineral Resources modified to produce Mineral Reserves.
- 3) The Mineral Resource estimates include Inferred Mineral Resources that are normally considered too speculative geologically to have economic considerations applied to them that would enable them to be categorized as Mineral Reserves. There is also no certainty that Inferred Mineral Resources will be converted to Measured and Indicated categories through further drilling, or into Mineral Reserves once economic considerations are applied.
- 4) The Gold Mineral Resource is estimated using a long-term gold price of US\$1,700/oz with a USD:AUD exchange rate of 0.70.
- 5) The Gold Mineral Resource for Higginsville is reported using a 0.5 g/t Au cut-off for open pits (except 0.4 g/t Au cut-off for Mt Henry Project) and a 1.3 g/t Au cut-off grade for underground (except 1.6 g/t Au for Spargos underground).
- 6) Mineral Resources are depleted for mining as of September 30, 2023.
- 7) To best represent 'reasonable prospects of eventual economic extraction' the mineral resource for open pits has been reported within an optimised pit shells at A\$2,429/oz (US\$1,700/oz) and, for underground resources, areas considered sterilised by historical mining are removed from the Mineral Resource estimation.
- 8) Mineral Resource tonnage and contained metal have been rounded to reflect the accuracy of the estimate, and numbers may not add up due to rounding.
- 9) CIM Definition Standards (2014) were followed in the calculation of Mineral Resources.
- 10) Gold Mineral Resource estimates were prepared under the supervision of Qualified Person S. Devlin, FAusIMM (Chief Geological Officer, Karora Resources) and I. Glacken (Geologist & Geostatistician, Snowden Optiro Pty Ltd). Mr. Glacken's responsibility is limited to the Mt Henry Project Mineral Resources.

1.5 MINERAL RESERVE ESTIMATES

The Higginsville Mineral Reserve Estimate is presented in Table 1-2.

Table 1-2 Higginsville Gold Mineral Reserves at September 30, 2023

Sep. 2023 Mineral Reserve	Proven			Probable			Proven & Probable		
	kt	g/t	koz	kt	g/t	koz	kt	g/t	koz
HGO Central	176	2.0	12	702	2.8	63	878	2.6	75
HGO Greater	7,497	1.3	320	4,925	1.8	285	12,422	1.5	605
Stockpiles	405	0.8	10	569	0.8	16	973	0.8	26
Total	8,078	1.3	342	6,196	1.8	363	14,273	1.5	705

- 1) The Mineral Reserve is reported at varying cut-off grades per deposit ranging from 1.6 g/t to 2.0 g/t for Underground Mineral Reserves to 0.8 g/t to 1.0 g/t for Open Pit Mineral Reserves.
- 2) Key assumptions used in the economic evaluation include:
 - a. A metal price of US\$1,500/oz gold and an exchange rate of 0.70 USD:AUD.
 - b. Metallurgical recovery varies by deposit.

- c. The cut-off grade takes into account operating, mining, processing/haulage and G&A costs, excluding capital.
- 3) The Mineral Reserve is depleted for all mining to September 30, 2023.
- 4) The tonnes and grades are stated to a number of significant digits reflecting the confidence of the estimate. Since each number is rounded individually, the table may show apparent inconsistencies between the sum of rounded components and the corresponding rounded total.
- 5) The Mineral Reserve tonnages and grades are estimated and reported as delivered to plant (the point where material is delivered to the mill) and is therefore inclusive of ore loss and dilution.
- 6) CIM Definition Standards (2014) were followed in the calculation of Mineral Reserves.
- 7) Gold Mineral Reserve estimates were prepared under the supervision of Qualified Person P Ganza, MAusIMM (CP).

1.6 OPERATIONS AND DEVELOPMENT

At HGO, the Higginsville Mill has been in operation since July 2008, and local mill feed variability is well understood. Since acquisition by Karora on June 10, 2019, the mill has received both Beta Hunt and HGO mineralisation for processing. The facility is a conventional carbon-in-leach (CIL) processing plant built by GR Engineering Services and commissioned in 2008. Originally designed to treat 1 Mtpa, with subsequent upgrades and modifications, the plant now has the capacity to treat material up to 1.6 Mtpa.

Since acquiring Higginsville in June 2019 until September 2023, the mill has processed 5.9 Mt @ 2.5 g/t. Mining is active at HGO's Two Boys underground mine and Pioneer open pit.

At LKO, the Lakewood Mill has experienced various owners and processing configurations and is now a conventional CIL processing plant. Since acquisition in July 2022 until September 2023, the facility has milled 0.97 Mt @ 1.9 g/t.

1.7 ENVIRONMENTAL STUDIES, PERMITTING, AND SOCIAL OR COMMUNITY IMPACT

The Higginsville Mill is in possession of all required permits. Environmental permitting and compliance requirements for mining and processing is the responsibility of Karora. The mill is part of the Higginsville Gold Operations which covers over 1,900 km² and has a significant disturbance footprint including tailings storage facilities (TSF), an operating processing facility, open pits, underground mines, and haul roads. The current workforce of 77 persons are mostly fly-in/fly-out (FIFO) workers from Perth who arrive at site by bus from Kambalda Airport. Karora runs charter flights from Perth to the Kambalda Airport on Tuesdays and Thursdays, with capacity for the entire FIFO workforce. The FIFO workers are supplemented by workers who reside in regional towns such as Norseman, Kambalda, Kalgoorlie and Esperance.

Lakewood Mill is a gold processing facility and in possession of all required permits. Environmental permitting and compliance requirements for mining and processing is the responsibility of Karora. Of the current workforce of 22 personnel, 90% reside locally.

The region is located in the state of Western Australia, which was ranked as the second-best jurisdiction in the world for mining investment by the Fraser Institute in their 2018 survey (Stedman & Green, 2018).

1.8 CAPITAL AND OPERATING COSTS

Karora operations has a long history of cost information for capital and operating costs and to the extent possible, mining, processing and site administration costs were derived from actual performance data, in addition to recent supplier quotations. As such, these costs are well understood and allow enough detail for Mineral Reserves to be declared.

The following data were used to inform the cost estimate.

1.8.1 Underground

The costs are scheduled based on combination of first principles and underground contractor unit costs and scheduled physicals. Fixed and variable costs have been included as appropriate. Personnel quantities (including mine management, supervision, underground personnel and maintenance) have been calculated from the activity required in the scheduled physicals and used to calculate salaries, wages, on costs, flights and accommodation.

Capital costs include non-sustaining capital for ventilation infrastructure upgrades and new equipment and sustaining capital in the form of mine development extending the decline, ventilation and electrical network.

1.8.2 Open Pit Mining

The costs are scheduled based on contractor unit costs. Fixed and variable costs have been included as appropriate. Personnel quantities (including mine management, supervision, open pit personnel and maintenance) have been calculated from the activity required in the scheduled physicals and used to calculate salaries, wages, on costs, flights, and accommodation. Capital costs have been separated.

1.8.3 Processing and Tailings Storage Facilities

The costs are scheduled based on first principles unit costs and the scheduled physicals. Fixed and variable costs have been included as appropriate. Personnel quantities (including mill management, supervision, mill operators and maintenance) have been calculated from the activity required in the scheduled physicals and used to calculate salaries, wages, on costs, flights, and accommodation.

Sustaining capital expenditure is allocated for tailings lifts, plant and process improvements including process optimisation, ongoing processing equipment costs (replacements, rebuilds and major overhauls), and other infrastructure replacement, including water security and electrical infrastructure.

1.8.4 General and Administration

The costs are scheduled based on first principles unit costs and scheduled physicals. Fixed and variable costs have been included as appropriate. Personnel quantities have been calculated from the activity required in the scheduled physicals and used to calculate salaries and wages.

1.8.5 Royalties

Gross royalties are calculated as respective percentage of block revenue less all relevant deductions applicable to that royalty.

The Net Smelter Royalties calculation takes into account revenue factors, metallurgical recovery assumptions, transport costs and refining charges. The site operating costs vary

between royalty and commodity and can include mining cost, processing cost, relevant site, transport, general and administration costs, and relevant sustaining capital costs.

1.8.6 Closure Costs

Closure costs are based on detailed estimates prepared under the mine closure plan.

1.9 CONCLUSION AND RECOMMENDATIONS

The recently updated Gold Mineral Reserves for the Higginsville-Lakewood Operations (HLO) provide the opportunity to deliver medium- to long-term security for the ongoing development of HLO.

Specific recommendations to support securing HLO's future include:

- Using the security of the Gold Mineral Reserve to develop medium- to long-term improvements in operational performance and costs, and also to provide leverage for capital investment if required.
- Complete a property-wide review of the Mineral Resources with the aim to prioritise extensional opportunities to support the combined mill capacity for future production.
- Realise the growth potential of the project by supporting exploration with sufficient funds to test high quality greenfields exploration targets.

2 INTRODUCTION

Karora Resources Inc. (Karora or the Company) is a Toronto headquartered mineral resource company focused on the exploration, development and acquisition of base and precious metals properties. The Company, previously called Royal Nickel Corporation, commenced trading under the new name of Karora Resources Inc. on June 17, 2020. Karora acquired 100% of the underground Beta Hunt Mine through a staged acquisition process in 2016 and later acquired the Higginsville Gold Operations (HGO) from Westgold Resources Limited (Westgold) in June 2019. The Company expanded HGO through the acquisition of the Spargos Reward Project on August 7, 2020. More recently, the Company acquired the Lakewood Gold Mill in July 2022. The Company currently operates the Beta Hunt Operation (BHO), the Higginsville Gold Operations (HGO) and Lakewood Operations (LKO) as an integrated operation with both BHO and HGO feeding the Higginsville and Lakewood Mills.

This Technical Report covers the Higginsville-Lakewood Operations and has been prepared by Karora following completion of updated Mineral Resources and Reserves for HGO effective September 30, 2023. The Report is available on the SEDAR website.

The Higginsville-Lakewood Operations (HLO) comprises the following:

- Higginsville Gold Operation (HGO) which includes the Higginsville Mill, 242 mineral leases (as of September 30, 2023) and underground and open pit mining operations including the Mt Henry, Spargos, Mitchell, Wills and Pioneer deposits.
- The Lakewood Operations (LKO) which includes the Lakewood Mill and associated infrastructure.

The Company has reported the Higginsville Mineral Resources and Reserve estimations under 'The Australasian Code for Reporting of Exploration Results, Mineral Resources and Ore Reserves 2012 Edition' (JORC, 2012; the JORC Code). There are no material differences between the definitions of 'Mineral Resource' and 'Mineral Reserve' under the applicable definitions adopted by the Canadian Institute of Mining, Metallurgy and Petroleum (the CIM Definition Standards) and the corresponding equivalent definitions in the JORC Code.

This Technical Report supports the updated Higginsville Mineral Resource and Reserve estimations and has been prepared in accordance with the disclosure and reporting requirements set forth in the Canadian Securities Administrators' National Instrument 43-101 (NI 43-101), Companion Policy 43-101CP and Form 43-101F1.

2.1 REPORT CONTRIBUTORS AND QUALIFIED PERSON

The Technical Report was assembled by Qualified Person (QP) Stephen Devlin. The details of all QPs and contributors are summarised in Table 2-1, along with dates that each QP and contributor visited the operation.

Table 2-1 Persons who prepared or contributed to this Technical Report

Name	Position	Employer	Independent	Operation Visit Date	Professional Designation	Contribution (section)
QUALIFIED PERSON RESPONSIBLE FOR THE PREPARATION AND SIGNING OF THIS TECHNICAL REPORT						
Stephen Devlin	Chief Geological Officer	Karora	No	Nov. 2023	FAusIMM	1,2,3,4,5,6,7,8, 9,10, 11, 12, 14 (except 14.6.6), 19, 20, 22, 23,24, 25, 26, 27
Peter Ganza	Chief Operating Officer	Karora	No	Nov. 2023	Chartered Professional Member of the AusIMM	13, 15, 16, 17, 18, 21
Ian Glacken	Geologist & Geostatician	Snowden Optiro	Yes	Feb. 2019	BSc (Hons) (Geology), MSc(Mining Geology), DIC, MSc (Geostatistics), Grad Dip Computing, FAusIMM(CP), FAIG, MIMMM, CEng	14.4.6
OTHER PERSONS WHO ASSISTED THE QUALIFIED PERSON						
Rindra le Grange	Senior Resource Geologist	Karora	No	Nov 23	Master's Degree in Geology, MAIG	14
Graham de la Mare	Principal Resource Geologist	Karora	No	Nov 23	FAIG	14
Peter Litic	Database Manager	Karora	No	Numerous. Last visit Nov 2023	Grad Dip (GIS)	10, 11
Glenn Reitsema	Principal Mining Engineer	Karora	No	Feb 2023	MAusIMM	15, 16, 21
Laura Noonan-Crowe	General Counsel & Company Secretary	Karora	No	May 2023	LLB, BA Admitted as a Barrister & Solicitor in the State of Western Australia	4, 19.2
Mark Atta-Danso	Superintendent Metallurgy, Karora Operations	Karora	No	Rostered on-site	BSc (Hons) (Mineral/Metallurgical Engineering), MSc (Mineral Economics) and MBA	13,17
Clint Kuehnappel	Manager Geology, HGO	Karora	No	Rostered on-site	B.Appl.Sc (Hons); MBA	9, 10,11
Alex Ruschmann	Manager - Environment	Karora	No	Employed Corporate	BSc (Hons) (Biological, Environmental & Marine)	4, 6, 18, 20
Rob Buchanan	Director, Investor Relations	Karora	No	Mar 29, 2023	BSc, CPIR, GCB.D	19.1

3 RELIANCE ON OTHER EXPERTS

The authors of this report have assumed and relied on the fact that all the information and technical documents listed in Section 27 (References), are accurate and complete in all material aspects. While the authors have carefully reviewed, within the scope of their technical expertise, all the available information presented to them, they cannot guarantee its accuracy and completeness. The authors reserve the right, but will not be obligated to, revise the Technical Report and its conclusions if additional information becomes known to them subsequent to the effective date of this report.

The authors are not experts with respect to legal, socio-economic, land title or political issues, and are therefore not qualified to comment on issues related to the status of permitting, legal agreements and royalties.

Information related to these matters has been provided directly by Karora and include, without limitation, validity of mineral tenure, status of environmental and other liabilities, and permitting to allow completion of annual assessment work.

These matters were not independently verified by the QPs and appear to be reasonable representations that are suitable for inclusion in this report. Furthermore, the authors have not attempted to verify the legal status of the property; however, the Department of Mines, Industry Regulation and Safety (DMIRS) reports that Karora’s mineral claims are active and in good standing at the effective date of this report.

Information sources and other parties relied upon to provide technical content and review are shown in Table 3-1.

Table 3-1 Other parties relied upon to provide technical content to this Technical Report

Information Supplied	Other Parties	Section
Ownership, title, social and environmental studies and information	Karora	1, 2, 4, 6, 7, 9, 10, 20
Infrastructure capital and operating estimates	Karora	1, 18, 21, 22
Market studies & contracts	Karora	1, 19

4 PROPERTY DESCRIPTION AND LOCATION

4.1 LOCATION

The Higginsville-Lakewood Operations (HLO) comprises two mills: the 1.6 Mtpa Higginsville Mill and the 1.0 Mtpa Lakewood Mill (permitted to upgrade to 1.2 Mtpa), four underground mines (one currently active) and 21 open pits (one currently active). Open pit mining is currently active at Pioneer. Underground mining is currently active at the Two Boys deposit.

The Higginsville Mill is located 80 km south of Beta Hunt by road and 107 km south of the regional mining centre of Kalgoorlie (Figure 4-1). The mill is accessed via the Coolgardie-Esperance Highway, which is located 1.2 km southwest of the mill.

The Lakewood Mill was acquired by Karora in July 2022. The mill is located 124 km by road north of the Higginsville Mill, 65 km by road north of Beta Hunt mine and approximately 4 km southeast of the City of Kalgoorlie-Boulder, which is the nearest occupied townsite.

4.2 MINERAL TENURE

4.2.1 Higginsville

The Higginsville-Lakewood Operations (HLO) includes the Higginsville and Lakewood Mills, associated infrastructure, mining operations and exploration prospects, all of which are located on 242 mining tenements (live) owned by Karora (Table 4-1, Figure 4-2 to Figure 4-4) covering a total area of approximately 1,800 km². In addition, Karora has applications pending for a further 37 mining tenements. DMIRS recently approved the mining proposal for the expansion of the Lakewood Mill to construct a new TSF 2 for tailings impoundment and to increase the total production rate up to 1.2 Mtpa.

In respect of each tenement, there is an expenditure commitment, rent payable to DMIRS and local rates. There is also an annual reporting requirement for each tenement or group of tenements, pursuant to the *Mining Act 1978* (WA) (Mining Act).

The tenements that make up the HLO are currently in good standing supported by Karora's strong compliance with regulatory reporting requirements and relevant operating conditions of licences and permits.

Figure 4-1 Higginsville-Lakewood Operations location map

Source: Karora

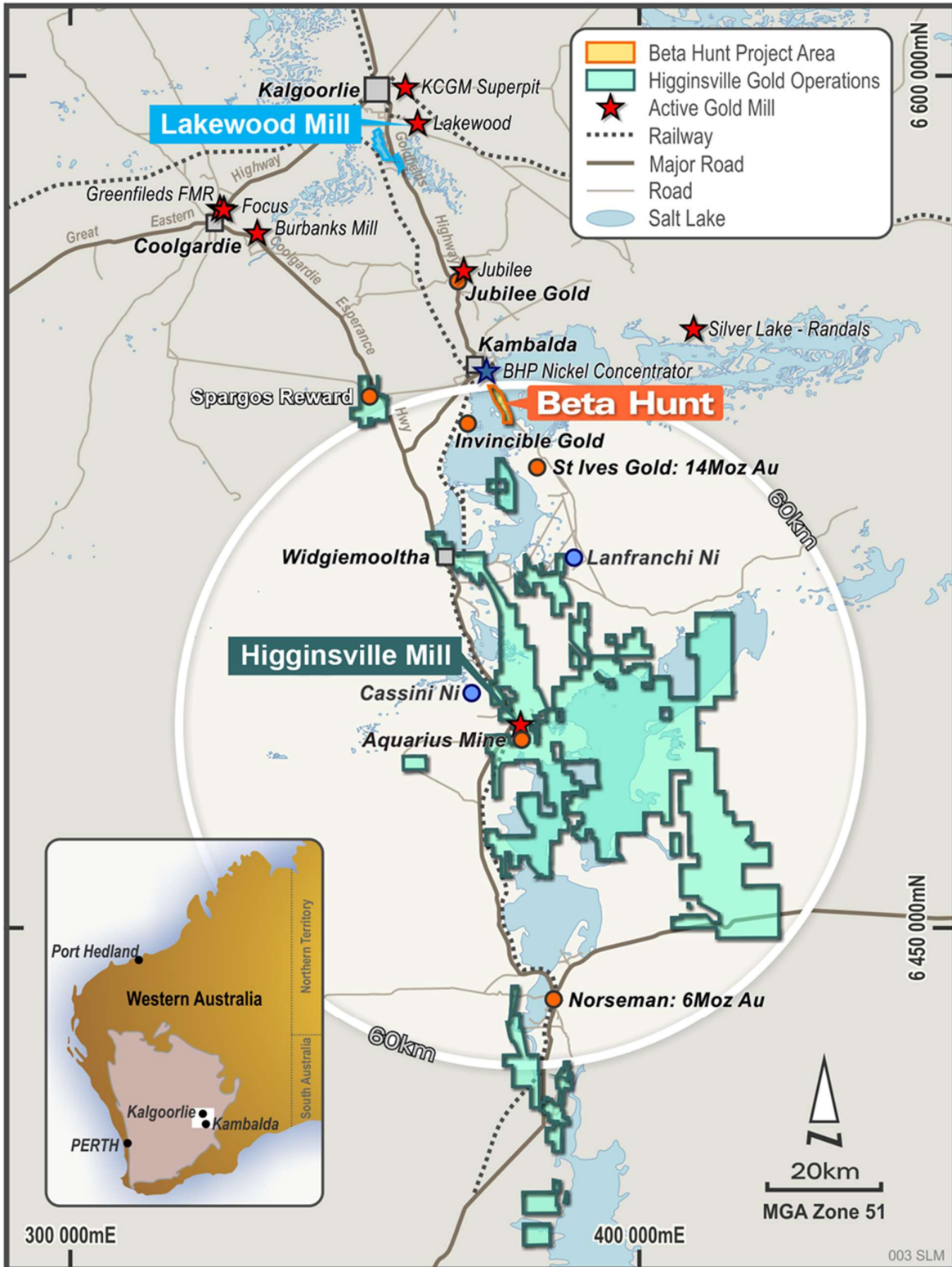

Table 4-1 HGO Mineral Tenure Information

Lease	Status	Commence	Expiry	Commitment	Next Rent	Approx Area ha	Holders
E15/1037	Live	2008-09-30	2024-09-29	\$105,000	\$26,145	9800	Avoca Resources Pty Ltd
E15/1094	Live	2009-08-13	2025-08-12	\$70,000	\$5,976	2240	Avoca Resources Pty Ltd
E15/1197	Live	2011-02-07	2025-02-06	\$70,000	\$7,470	2800	Avoca Resources Pty Ltd
E15/1199	Live	2010-11-10	2024-11-09	\$50,000	\$1,494	560	Avoca Resources Pty Ltd
E15/1203	Live	2010-12-17	2024-12-16	\$70,000	\$14,193	5320	Avoca Resources Pty Ltd
E15/1223	Live	2011-09-08	2025-09-07	\$70,000	\$11,952	4480	Avoca Resources Pty Ltd
E15/1260	Live	2011-10-12	2025-10-11	\$20,000	\$447	280	Avoca Resources Pty Ltd
E15/1298	Live	2012-07-31	2024-07-30	\$50,000	\$2,241	840	Polar Metals Pty Ltd
E15/1402	Live	2014-04-08	2024-04-07	\$20,000	\$447	280	Avoca Mining Pty Ltd
E15/1423	Live	2014-12-30	2024-12-29	\$70,000	\$5,976	2240	Corona Minerals Pty Ltd
E15/1448	Live	2015-05-06	2025-05-05	\$20,000	\$447	280	Avoca Resources Pty Ltd
E15/1458	Live	2015-08-24	2025-08-23	\$70,000	\$11,952	4480	"Polar Metals Pty Ltd (80%) Shumwari Pty Ltd (20%)"
E15/1459	Live	2015-08-25	2025-08-24	\$50,000	\$1,494	560	"Polar Metals Pty Ltd (80%) Shumwari Pty Ltd (20%)"
E15/1461	Live	2015-10-16	2025-10-15	\$70,000	\$5,229	1960	Polar Metals Pty Ltd
E15/1462	Live	2015-09-22	2025-09-21	\$20,000	\$447	280	Avoca Resources Pty Ltd
E15/1464	Live	2015-10-06	2025-10-05	\$20,000	\$447	280	"Polar Metals Pty Ltd (80%) Shumwari Pty Ltd (20%)"
E15/1487	Live	2016-07-01	2026-06-30	\$70,000	\$8,217	3080	Polar Metals Pty Ltd
E15/1512	Live	2018-03-19	2028-03-18	\$15,000	\$395	280	Avoca Mining Pty Ltd
E15/1533	Live	2017-10-11	2027-10-10	\$30,000	\$3,735	1400	Avoca Resources Pty Ltd
E15/1541	Live	2017-10-11	2027-10-10	\$50,000	\$4,482	1680	Polar Metals Pty Ltd
E15/1586	Live	2017-10-06	2027-10-05	\$30,000	\$1,494	560	Avoca Mining Pty Ltd
E15/1613	Live	2022-02-02	2027-02-01	\$10,000	\$447	280	Avoca Mining Pty Ltd
E15/1628	Live	2018-11-26	2028-11-25	\$72,000	\$14,220	10080	Avoca Mining Pty Ltd
E15/1792	Live	2021-04-19	2026-04-18	\$15,000	\$1,156	1120	Avoca Mining Pty Ltd
E15/1793	Live	2021-04-19	2026-04-18	\$10,000	\$447	280	Avoca Mining Pty Ltd
E15/1850	Live	2022-07-04	2027-07-03	\$15,000	\$322	560	Avoca Mining Pty Ltd
E15/1851	Live	2022-07-04	2027-07-03	\$20,000	\$1,288	2240	Avoca Mining Pty Ltd
E15/1860	Live	2022-07-04	2027-07-03	\$15,000	\$483	840	Avoca Mining Pty Ltd
E15/1861	Live	2022-07-04	2027-07-03	\$10,000	\$447	280	Avoca Mining Pty Ltd
E15/1863	Live	2022-09-02	2027-09-01	\$10,000	\$447	280	Avoca Mining Pty Ltd
E15/786	Live	2005-10-28	2023-10-27	\$70,000	\$10,458	3920	Avoca Resources Pty Ltd
E15/808	Live	2006-07-05	2024-07-04	\$70,000	\$6,723	2520	Avoca Resources Pty Ltd
E15/810	Live	2004-08-04	2024-08-03	\$102,000	\$25,398	9520	Avoca Resources Pty Ltd
E15/828	Live	2004-11-17	2023-11-16	\$70,000	\$14,940	5600	Avoca Mining Pty Ltd
E63/1051	Live	2007-07-03	2023-07-02	\$50,000	\$2,988	1120	Avoca Resources Pty Ltd
E63/1117	Live	2008-10-07	2024-10-06	\$50,000	\$3,735	1400	"Avoca Resources Pty Ltd (93.33%) Stehn, Trent Paterson (6.67%)"
E63/1142	Live	2009-02-13	2025-02-12	\$70,000	\$14,940	5600	Polar Metals Pty Ltd
E63/1165	Live	2008-04-15	2024-04-14	\$50,000	\$3,735	1400	Avoca Resources Pty Ltd
E63/1712	Live	2015-05-25	2025-05-24	\$70,000	\$9,711	3640	Polar Metals Pty Ltd
E63/1724	Live	2015-09-01	2025-08-31	\$20,000	\$447	280	Avoca Resources Pty Ltd
E63/1725	Live	2015-10-26	2025-10-25	\$70,000	\$5,976	2240	Polar Metals Pty Ltd
E63/1726	Live	2015-09-01	2025-08-31	\$70,000	\$6,723	2520	"Polar Metals Pty Ltd (80%) Shumwari Pty Ltd (20%)"

Lease	Status	Commence	Expiry	Commitment	Next Rent	Approx Area ha	Holders
E63/1727	Live	2015-09-01	2025-08-31	\$20,000	\$447	280	"Polar Metals Pty Ltd (80%) Shumwari Pty Ltd (20%)"
E63/1728	Live	2016-01-06	2026-01-05	\$126,000	\$-	11760	Polar Metals Pty Ltd
E63/1738	Live	2015-10-19	2025-10-18	\$50,000	\$1,494	560	"Polar Metals Pty Ltd (80%) Shumwari Pty Ltd (20%)"
E63/1756	Live	2016-02-09	2026-02-08	\$50,000	\$2,988	1120	Polar Metals Pty Ltd
E63/1763	Live	2017-05-08	2027-05-07	\$50,000	\$5,229	1960	Avoca Mining Pty Ltd
E63/1876	Live	2018-07-02	2028-07-01	\$50,000	\$2,765	1960	Avoca Mining Pty Ltd
E63/1881	Live	2018-06-01	2028-05-31	\$50,000	\$3,555	2520	Avoca Mining Pty Ltd
E63/1900	Live	2019-03-20	2024-03-19	\$30,000	\$2,370	1680	Avoca Mining Pty Ltd
E63/1901	Live	2019-03-20	2024-03-19	\$20,000	\$790	560	Avoca Mining Pty Ltd
E63/2093	Live	2022-02-28	2027-02-27	\$15,000	\$805	1400	Avoca Mining Pty Ltd
E63/2094	Live	2022-02-28	2027-02-27	\$10,000	\$447	280	Avoca Mining Pty Ltd
E63/2095	Live	2022-02-28	2027-02-27	\$10,000	\$447	280	Avoca Mining Pty Ltd
E63/2096	Live	2022-02-28	2027-02-27	\$10,000	\$447	280	Avoca Mining Pty Ltd
E63/2178	Live	2022-08-16	2027-08-15	\$20,000	\$1,288	2240	Avoca Mining Pty Ltd
E63/2179	Live	2022-08-16	2027-08-15	\$20,000	\$1,127	1960	Avoca Mining Pty Ltd
E63/2180	Live	2023-05-11	2028-05-10	\$20,000	\$966	1680	Avoca Mining Pty Ltd
E63/2181	Live	2022-08-16	2027-08-15	\$20,000	\$1,127	1960	Avoca Mining Pty Ltd
E63/856	Live	2004-09-06	2024-09-05	\$70,000	\$17,181	6440	Avoca Resources Pty Ltd
G15/19	Live	2007-10-03	2028-10-02		\$1,584	66	Avoca Mining Pty Ltd
G15/23	Live	2015-06-02	2036-06-01		\$96	3	Avoca Mining Pty Ltd
G15/26	Live	2016-11-09	2037-11-08		\$2,280	94	Avoca Mining Pty Ltd
G15/27	Live	2016-11-09	2037-11-08		\$3,528	146	Avoca Mining Pty Ltd
G15/29	Live	2017-01-27	2038-01-26		\$-	6	Avoca Mining Pty Ltd
G63/6	Live	2015-08-28	2036-08-27		\$6,744	281	Avoca Mining Pty Ltd
G63/7	Live	2016-04-27	2037-04-26		\$4,416	183	Avoca Mining Pty Ltd
L15/233	Live	2002-09-16	2044-09-15		\$2,136	89	Avoca Mining Pty Ltd
L15/244	Live	2003-04-14	2045-04-13		\$-	5	Avoca Mining Pty Ltd
L15/259	Live	2006-06-02	2027-06-01		\$672	28	Avoca Mining Pty Ltd
L15/261	Live	2006-06-02	2027-06-01		\$72	3	Avoca Mining Pty Ltd
L15/272	Live	2006-08-09	2027-08-08		\$288	12	Avoca Mining Pty Ltd
L15/282	Live	2008-03-13	2029-03-12		\$1,776	73	Avoca Mining Pty Ltd
L15/288	Live	2008-11-27	2029-11-26		\$840	35	Avoca Mining Pty Ltd
L15/298	Live	2009-06-24	2030-06-23		\$1,248	51	Avoca Mining Pty Ltd
L15/302	Live	2010-12-17	2031-12-16		\$216	8	Avoca Mining Pty Ltd
L15/308	Live	2010-12-17	2031-12-16		\$1,080	44	Avoca Mining Pty Ltd
L15/322	Live	2011-10-06	2032-10-05		\$624	26	Avoca Mining Pty Ltd
L15/346	Live	2014-05-13	2035-05-12		\$816	33	Avoca Mining Pty Ltd
L15/347	Live	2014-07-25	2035-07-24		\$288	12	Avoca Mining Pty Ltd
L15/368	Live	2019-06-07	2040-06-06		\$2,472	103	Avoca Mining Pty Ltd
L15/377	Live	2019-04-26	2040-04-25		\$192	8	Avoca Mining Pty Ltd
L15/381	Live	2018-10-25	2039-10-24		\$576	24	Avoca Mining Pty Ltd
L15/382	Live	2018-09-27	2039-09-26		\$360	15	Avoca Mining Pty Ltd
L15/386	Live	2018-08-29	2039-08-28		\$6,600	275	Avoca Mining Pty Ltd
L15/389	Live	2019-02-08	2040-02-07		\$288	12	Avoca Mining Pty Ltd
L15/393	Live	2019-05-29	2040-05-28		\$2,208	92	Avoca Mining Pty Ltd
L15/415	Live	2022-04-07	2043-04-06		\$264	10	Avoca Mining Pty Ltd

Lease	Status	Commence	Expiry	Commitment	Next Rent	Approx Area ha	Holders
L26/234	Live	2008-04-03	2029-04-02		\$792	33	Lakewood Mining Pty Ltd
L26/281	Live	2017-08-17	2038-08-16		\$48	1	Salt Lake Mining Pty Ltd
L26/293	Live	2022-07-25	2043-07-24		\$96	4	Lakewood Mining Pty Ltd
L63/58	Live	2007-07-19	2028-07-18		\$768	32	Avoca Mining Pty Ltd
L63/64	Live	2010-04-29	2031-04-28		\$168	7	Avoca Mining Pty Ltd
L63/72	Live	2015-10-07	2036-10-06		\$72	3	Avoca Mining Pty Ltd
L63/73	Live	2015-09-01	2036-08-31		\$936	38	Avoca Resources Pty Ltd
M15/1132	Live	2002-10-02	2044-10-01	\$92,000	\$23,920	919	Avoca Mining Pty Ltd
M15/1133	Live	2002-10-02	2044-10-01	\$79,300	\$20,618	792	Avoca Mining Pty Ltd
M15/1134	Live	2002-10-02	2044-10-01	\$60,000	\$15,600	599	Avoca Mining Pty Ltd
M15/1135	Live	2002-10-02	2044-10-01	\$90,600	\$23,556	905	Avoca Mining Pty Ltd
M15/1790	Live	2013-07-08	2034-07-07	\$62,300	\$16,198	623	Avoca Mining Pty Ltd
M15/1792	Live	2013-07-25	2034-07-24	\$108,800	\$28,288	1088	Avoca Resources Pty Ltd
M15/1806	Live	2012-12-24	2033-12-23	\$33,800	\$8,788	338	Corona Minerals Pty Ltd
M15/1814	Live	2018-07-12	2039-07-11	\$114,600	\$29,796	1146	Polar Metals Pty Ltd
M15/1828	Live	2016-12-15	2037-12-14	\$100,400	\$26,104	1004	Corona Minerals Pty Ltd
M15/1873	Live	2020-08-06	2041-08-05	\$10,000	\$2,106	80	Avoca Mining Pty Ltd
M15/225	Live	1987-01-28	2029-01-27	\$10,000	\$-	17	Avoca Mining Pty Ltd
M15/231	Live	1987-11-03	2029-11-02	\$10,000	\$520	19	Avoca Mining Pty Ltd
M15/289	Live	1987-11-03	2029-11-02	\$10,000	\$260	10	Avoca Mining Pty Ltd
M15/31	Live	1983-08-24	2025-08-23	\$10,000	\$260	10	Avoca Mining Pty Ltd
M15/325	Live	1988-03-09	2030-03-08	\$5,000	\$78	2	Avoca Mining Pty Ltd
M15/338	Live	1988-03-14	2030-03-13	\$13,000	\$3,380	129	Avoca Mining Pty Ltd
M15/348	Live	1988-03-25	2030-03-24	\$49,500	\$12,870	495	Avoca Mining Pty Ltd
M15/351	Live	1988-05-02	2030-05-01	\$34,300	\$8,918	343	Avoca Mining Pty Ltd
M15/352	Live	1988-05-02	2030-05-01	\$10,000	\$624	23	Avoca Mining Pty Ltd
M15/375	Live	1988-04-22	2030-04-21	\$39,800	\$10,348	397	Avoca Mining Pty Ltd
M15/506	Live	1990-05-07	2032-05-06	\$77,900	\$20,254	779	Avoca Mining Pty Ltd
M15/507	Live	1990-05-07	2032-05-06	\$34,700	\$9,022	347	Avoca Mining Pty Ltd
M15/512	Live	1990-04-02	2032-04-01	\$10,000	\$520	19	Avoca Mining Pty Ltd
M15/528	Live	1991-03-21	2033-03-20	\$10,000	\$286	10	Avoca Mining Pty Ltd
M15/580	Live	1991-08-01	2033-07-31	\$96,200	\$25,012	962	Avoca Mining Pty Ltd
M15/581	Live	1991-08-01	2033-07-31	\$48,100	\$12,506	480	Avoca Mining Pty Ltd
M15/597	Live	1992-01-06	2034-01-05	\$59,600	\$-	595	Avoca Mining Pty Ltd
M15/610	Live	1991-12-10	2033-12-09	\$17,400	\$4,524	174	Avoca Mining Pty Ltd
M15/616	Live	1992-11-18	2034-11-17	\$66,700	\$17,342	667	Avoca Mining Pty Ltd
M15/620	Live	1992-10-20	2034-10-19	\$12,000	\$3,120	120	Avoca Mining Pty Ltd
M15/629	Live	1992-10-20	2034-10-19	\$12,100	\$3,146	120	Avoca Mining Pty Ltd
M15/639	Live	1993-01-25	2035-01-24	\$84,700	\$-	847	Avoca Mining Pty Ltd
M15/640	Live	1993-01-25	2035-01-24	\$72,700	\$-	726	Avoca Mining Pty Ltd
M15/642	Live	1993-01-25	2035-01-24	\$93,500	\$-	934	Avoca Mining Pty Ltd
M15/651	Live	1993-02-11	2035-02-10	\$13,800	\$3,588	137	Polar Metals Pty Ltd
M15/665	Live	1993-10-14	2035-10-13	\$87,600	\$22,776	875	Avoca Mining Pty Ltd
M15/680	Live	1994-03-01	2036-02-28	\$68,600	\$17,836	686	Avoca Mining Pty Ltd
M15/681	Live	1994-03-01	2036-02-28	\$94,400	\$24,544	943	Avoca Mining Pty Ltd
M15/682	Live	1994-03-30	2036-03-29	\$87,700	\$22,802	876	Avoca Mining Pty Ltd
M15/683	Live	1994-03-01	2036-02-28	\$78,500	\$20,410	784	Avoca Mining Pty Ltd

Lease	Status	Commence	Expiry	Commitment	Next Rent	Approx Area ha	Holders
M15/684	Live	1994-03-01	2036-02-28	\$79,900	\$20,774	799	Avoca Mining Pty Ltd
M15/685	Live	1994-03-01	2036-02-28	\$84,000	\$21,840	840	Avoca Mining Pty Ltd
M15/710	Live	1994-08-10	2036-08-09	\$66,700	\$17,342	666	Polar Metals Pty Ltd
M15/748	Live	1995-02-08	2037-02-07	\$10,000	\$234	9	Avoca Mining Pty Ltd
M15/757	Live	1995-03-03	2037-03-02	\$41,800	\$10,868	418	Avoca Mining Pty Ltd
M15/758	Live	1995-03-03	2037-03-02	\$89,200	\$23,192	892	Avoca Mining Pty Ltd
M15/786	Live	1995-04-27	2037-04-26	\$95,500	\$24,830	954	Avoca Mining Pty Ltd
M15/815	Live	1997-01-08	2039-01-07	\$94,400	\$-	944	Avoca Mining Pty Ltd
M15/817	Live	1996-09-23	2038-09-22	\$91,900	\$23,894	919	Avoca Mining Pty Ltd
M15/820	Live	1996-08-19	2038-08-18	\$96,800	\$25,168	968	Avoca Mining Pty Ltd
M26/242	Live	1988-10-18	2030-10-17	\$14,200	\$3,692	142	Lakewood Mining Pty Ltd
M26/367	Live	1993-05-12	2035-05-11	\$5,000	\$78	2	Lakewood Mining Pty Ltd
M63/165	Live	1988-02-16	2030-02-15	\$20,200	\$5,252	202	Avoca Mining Pty Ltd
M63/230	Live	1990-11-19	2032-11-18	\$49,700	\$12,922	497	Polar Metals Pty Ltd
M63/236	Live	1991-08-09	2033-08-08	\$10,000	\$260	9	Avoca Mining Pty Ltd
M63/255	Live	1992-10-22	2034-10-21	\$37,000	\$9,620	369	Polar Metals Pty Ltd
M63/269	Live	1993-10-01	2035-09-30	\$64,900	\$16,874	649	Polar Metals Pty Ltd
M63/279	Live	1994-03-23	2036-03-22	\$10,000	\$338	13	Polar Metals Pty Ltd
M63/329	Live	2001-07-23	2043-07-22	\$10,000	\$2,054	79	"Avoca Resources Pty Ltd (93.33%) Stehn, Trent Paterson (6.67%)"
M63/366	Live	2010-07-30	2031-07-29	\$10,000	\$1,404	54	Avoca Mining Pty Ltd
M63/368	Live	2001-07-23	2043-07-22	\$33,100	\$8,606	331	"Avoca Resources Pty Ltd (93.33%) Stehn, Trent Paterson (6.67%)"
M63/515	Live	2007-08-29	2028-08-28	\$70,900	\$18,434	709	Avoca Mining Pty Ltd
M63/516	Live	2007-08-29	2028-08-28	\$71,100	\$18,486	710	Avoca Mining Pty Ltd
M63/647	Live	2013-08-06	2034-08-05	\$99,800	\$25,948	998	Avoca Resources Pty Ltd
P15/5958	Live	2015-12-22	2023-12-21	\$2,000	\$164	41	Polar Metals Pty Ltd
P15/5959	Live	2015-12-22	2023-12-21	\$2,000	\$84	21	Polar Metals Pty Ltd
P15/6179	Live	2018-10-11	2026-10-10	\$2,000	\$84	21	Avoca Mining Pty Ltd
P15/6229	Live	2022-07-11	2026-07-10	\$3,840	\$384	96	Avoca Mining Pty Ltd
P15/6230	Live	2019-03-28	2027-03-27	\$5,160	\$516	129	Avoca Mining Pty Ltd
P15/6231	Live	2022-07-12	2026-07-11	\$5,560	\$556	139	Avoca Mining Pty Ltd
P15/6234	Live	2022-07-11	2026-07-10	\$3,320	\$332	83	Avoca Mining Pty Ltd
P15/6239	Live	2021-12-21	2025-12-20	\$4,880	\$488	121	Avoca Mining Pty Ltd
P15/6240	Live	2021-04-20	2025-04-19	\$4,720	\$472	118	Avoca Mining Pty Ltd
P15/6575	Live	2021-07-22	2025-07-21	\$7,520	\$752	188	Avoca Mining Pty Ltd
P15/6582	Live	2021-06-08	2025-06-07	\$2,000	\$37	3	Avoca Mining Pty Ltd
P15/6664	Live	2023-01-27	2027-01-26	\$2,600	\$-	64	Avoca Mining Pty Ltd
P15/6665	Live	2023-01-27	2027-01-26	\$2,000	\$-	24	Avoca Mining Pty Ltd
P26/4048	Live	2015-12-15	2023-12-14	\$8,000	\$800	200	Salt Lake Mining Pty Ltd
P26/4148	Live	2016-08-16	2024-08-15	\$7,680	\$768	192	Salt Lake Mining Pty Ltd
P26/4149	Live	2017-02-13	2025-02-12	\$7,920	\$792	198	Salt Lake Mining Pty Ltd
P26/4150	Live	2017-01-06	2025-01-05	\$7,960	\$-	199	Salt Lake Mining Pty Ltd
P26/4151	Live	2017-02-13	2025-02-12	\$4,360	\$436	109	Salt Lake Mining Pty Ltd
P63/1468	Live	2008-06-03	2016-06-02	\$2,000	\$52	13	"Avoca Resources Pty Ltd (93.33%) Stehn, Trent Paterson (6.67%)"

Lease	Status	Commence	Expiry	Commitment	Next Rent	Approx Area ha	Holders
P63/1587	Live	2009-06-10	2017-06-09	\$4,880	\$488	121	Polar Metals Pty Ltd
P63/1588	Live	2009-06-10	2017-06-09	\$4,840	\$484	120	Polar Metals Pty Ltd
P63/1589	Live	2009-06-10	2017-06-09	\$4,880	\$488	121	Polar Metals Pty Ltd
P63/1590	Live	2009-06-10	2017-06-09	\$4,800	\$480	120	Polar Metals Pty Ltd
P63/1591	Live	2009-06-10	2017-06-09	\$4,880	\$488	121	Polar Metals Pty Ltd
P63/1592	Live	2009-06-10	2017-06-09	\$4,880	\$488	121	Polar Metals Pty Ltd
P63/1593	Live	2009-06-10	2017-06-09	\$4,880	\$488	121	Polar Metals Pty Ltd
P63/1594	Live	2009-06-10	2017-06-09	\$4,880	\$488	121	Polar Metals Pty Ltd
P63/1977	Live	2015-03-03	2023-03-02	\$3,520	\$352	88	Avoca Resources Pty Ltd
P63/2011	Live	2017-05-08	2025-05-07	\$6,800	\$680	170	Avoca Mining Pty Ltd
P63/2012	Live	2017-05-08	2025-05-07	\$6,560	\$656	164	Avoca Mining Pty Ltd
P63/2013	Live	2017-05-09	2025-05-08	\$7,240	\$724	181	Avoca Mining Pty Ltd
P63/2014	Live	2017-05-09	2025-05-08	\$5,880	\$588	147	Avoca Mining Pty Ltd
P63/2015	Live	2017-05-09	2025-05-08	\$4,720	\$472	117	Avoca Mining Pty Ltd
P63/2025	Live	2017-05-08	2025-05-07	\$5,760	\$576	144	Avoca Mining Pty Ltd
P63/2050	Live	2017-05-08	2025-05-07	\$7,320	\$732	182	Avoca Mining Pty Ltd
P63/2051	Live	2017-05-08	2025-05-07	\$6,040	\$604	151	Avoca Mining Pty Ltd
P63/2064	Live	2017-07-20	2025-07-19	\$2,000	\$84	21	Avoca Mining Pty Ltd
P63/2067	Live	2017-05-09	2025-05-08	\$6,880	\$688	172	Avoca Mining Pty Ltd
P63/2080	Live	2018-04-13	2026-04-12	\$2,000	\$80	19	Avoca Mining Pty Ltd
P63/2094	Live	2018-01-18	2026-01-17	\$6,760	\$-	168	Avoca Mining Pty Ltd
P63/2095	Live	2018-01-18	2026-01-17	\$7,360	\$-	183	Avoca Mining Pty Ltd
P63/2097	Live	2018-01-18	2026-01-17	\$6,000	\$-	149	Avoca Mining Pty Ltd
P63/2100	Live	2018-06-05	2026-06-04	\$7,280	\$728	182	Avoca Mining Pty Ltd
P63/2101	Live	2018-06-06	2026-06-05	\$4,080	\$408	102	Avoca Mining Pty Ltd
P63/2102	Live	2018-06-06	2026-06-05	\$3,640	\$364	91	Avoca Mining Pty Ltd
P63/2119	Live	2018-10-10	2026-10-09	\$4,080	\$408	102	Avoca Mining Pty Ltd
P63/2120	Live	2018-10-10	2026-10-09	\$4,240	\$424	106	Avoca Mining Pty Ltd
P63/2121	Live	2018-10-10	2026-10-09	\$4,840	\$484	121	Avoca Mining Pty Ltd
P63/2122	Live	2018-10-10	2026-10-09	\$5,200	\$520	130	Avoca Mining Pty Ltd
P63/2125	Live	2019-04-09	2027-04-08	\$7,880	\$788	197	Avoca Mining Pty Ltd
P63/2126	Live	2019-04-09	2027-04-08	\$7,760	\$776	194	Avoca Mining Pty Ltd
P63/2203	Live	2021-04-19	2025-04-18	\$7,800	\$780	194	Avoca Mining Pty Ltd
P63/2204	Live	2021-04-19	2025-04-18	\$8,000	\$800	199	Avoca Mining Pty Ltd
P63/2205	Live	2021-04-19	2025-04-18	\$4,480	\$448	111	Avoca Mining Pty Ltd
P63/2206	Live	2021-04-19	2025-04-18	\$6,840	\$684	171	Avoca Mining Pty Ltd
P63/2207	Live	2021-04-19	2025-04-18	\$7,960	\$796	199	Avoca Mining Pty Ltd
P63/2208	Live	2021-06-08	2025-06-07	\$8,000	\$800	200	Avoca Mining Pty Ltd
P63/2209	Live	2021-06-08	2025-06-07	\$7,320	\$732	182	Avoca Mining Pty Ltd
P63/2210	Live	2021-06-08	2025-06-07	\$7,920	\$792	198	Avoca Mining Pty Ltd
P63/2211	Live	2021-06-08	2025-06-07	\$7,760	\$776	193	Avoca Mining Pty Ltd
P63/2232	Live	2021-10-20	2025-10-19	\$4,760	\$476	118	Avoca Mining Pty Ltd
P63/2233	Live	2021-10-20	2025-10-19	\$3,600	\$360	90	Avoca Mining Pty Ltd
P63/2234	Live	2021-10-20	2025-10-19	\$7,120	\$712	177	Avoca Mining Pty Ltd
P63/2235	Live	2021-10-20	2025-10-19	\$7,560	\$756	188	Avoca Mining Pty Ltd
P63/2236	Live	2021-10-20	2025-10-19	\$7,600	\$760	189	Avoca Mining Pty Ltd
P63/2237	Live	2021-10-20	2025-10-19	\$7,360	\$736	183	Avoca Mining Pty Ltd

Lease	Status	Commence	Expiry	Commitment	Next Rent	Approx Area ha	Holders
P63/2241	Live	2021-10-18	2025-10-17	\$7,800	\$780	195	Avoca Mining Pty Ltd
P63/2242	Live	2021-10-18	2025-10-17	\$5,200	\$520	129	Avoca Mining Pty Ltd
P63/2245	Live	2021-10-18	2025-10-17	\$7,520	\$752	187	Avoca Mining Pty Ltd
P63/2246	Live	2023-03-31	2027-03-30	\$7,120	\$712	177	Avoca Mining Pty Ltd
P63/2247	Live	2021-10-18	2025-10-17	\$7,840	\$784	195	Avoca Mining Pty Ltd
P63/2248	Live	2021-10-18	2025-10-17	\$2,440	\$244	61	Avoca Mining Pty Ltd
P63/2249	Live	2021-10-18	2025-10-17	\$7,080	\$708	176	Avoca Mining Pty Ltd
P63/2250	Live	2021-10-18	2025-10-17	\$7,640	\$764	191	Avoca Mining Pty Ltd
P63/2251	Live	2021-10-18	2025-10-17	\$6,440	\$644	161	Avoca Mining Pty Ltd
P63/2252	Live	2021-10-18	2025-10-17	\$6,760	\$676	168	Avoca Mining Pty Ltd
P63/2253	Live	2021-10-18	2025-10-17	\$5,680	\$568	141	Avoca Mining Pty Ltd
P63/2254	Live	2021-10-18	2025-10-17	\$3,680	\$368	92	Avoca Mining Pty Ltd
P63/2255	Live	2021-10-21	2025-10-20	\$4,120	\$412	102	Avoca Mining Pty Ltd
P63/2256	Live	2021-10-18	2025-10-17	\$7,440	\$744	186	Avoca Mining Pty Ltd
P63/2257	Live	2021-10-18	2025-10-17	\$7,600	\$760	189	Avoca Mining Pty Ltd
P63/2258	Live	2021-10-18	2025-10-17	\$5,440	\$544	135	Avoca Mining Pty Ltd
P63/2260	Live	2022-09-01	2026-08-31	\$2,000	\$92	22	Avoca Mining Pty Ltd
Total: 242				\$6,409,860	\$1,101,983	183,672	

Figure 4-2 Higginsville-Lakewood Operations map showing location of mineral tenure

Source: Karora

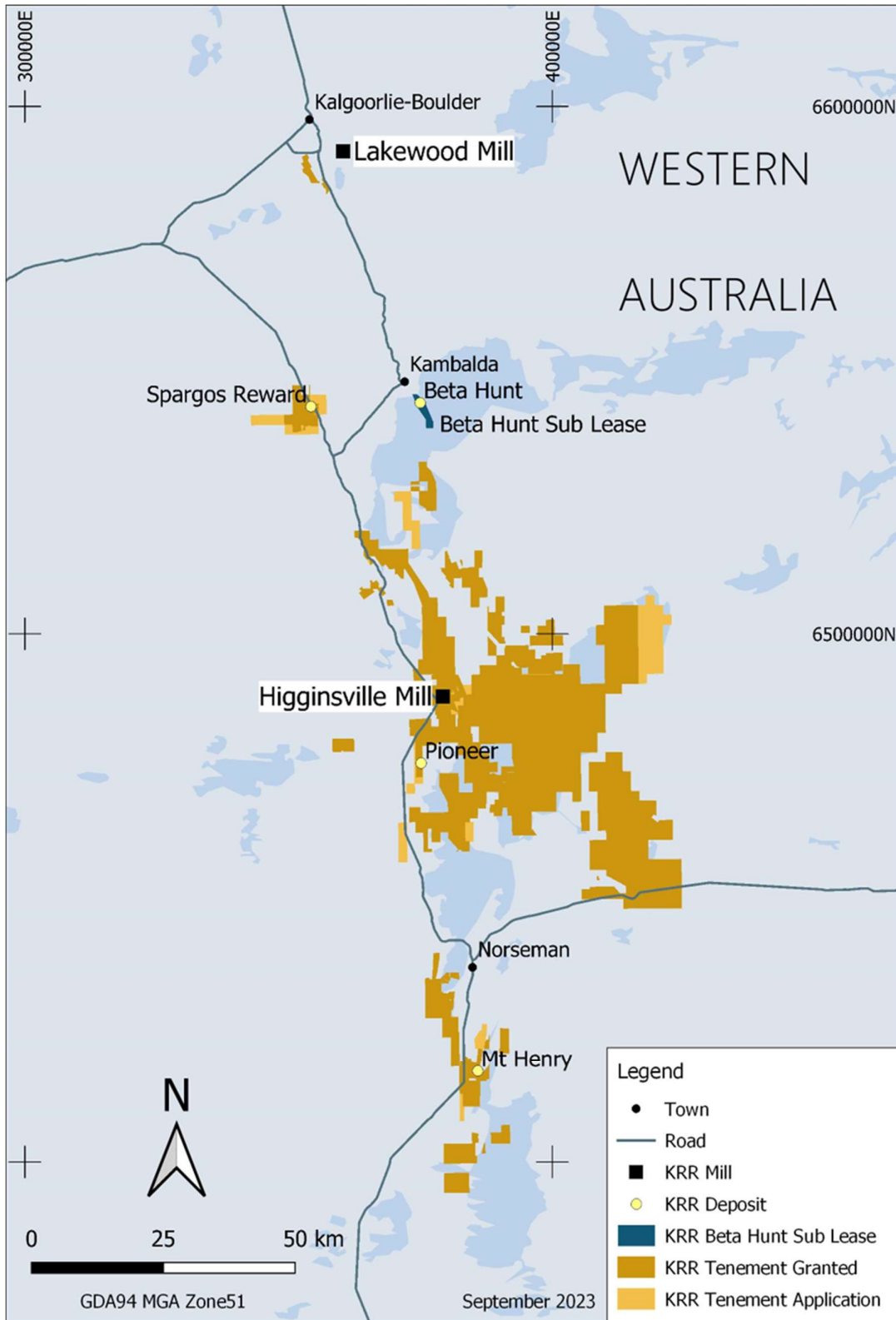

Figure 4-3 Higginsville Mill tenure map

Source: Karora

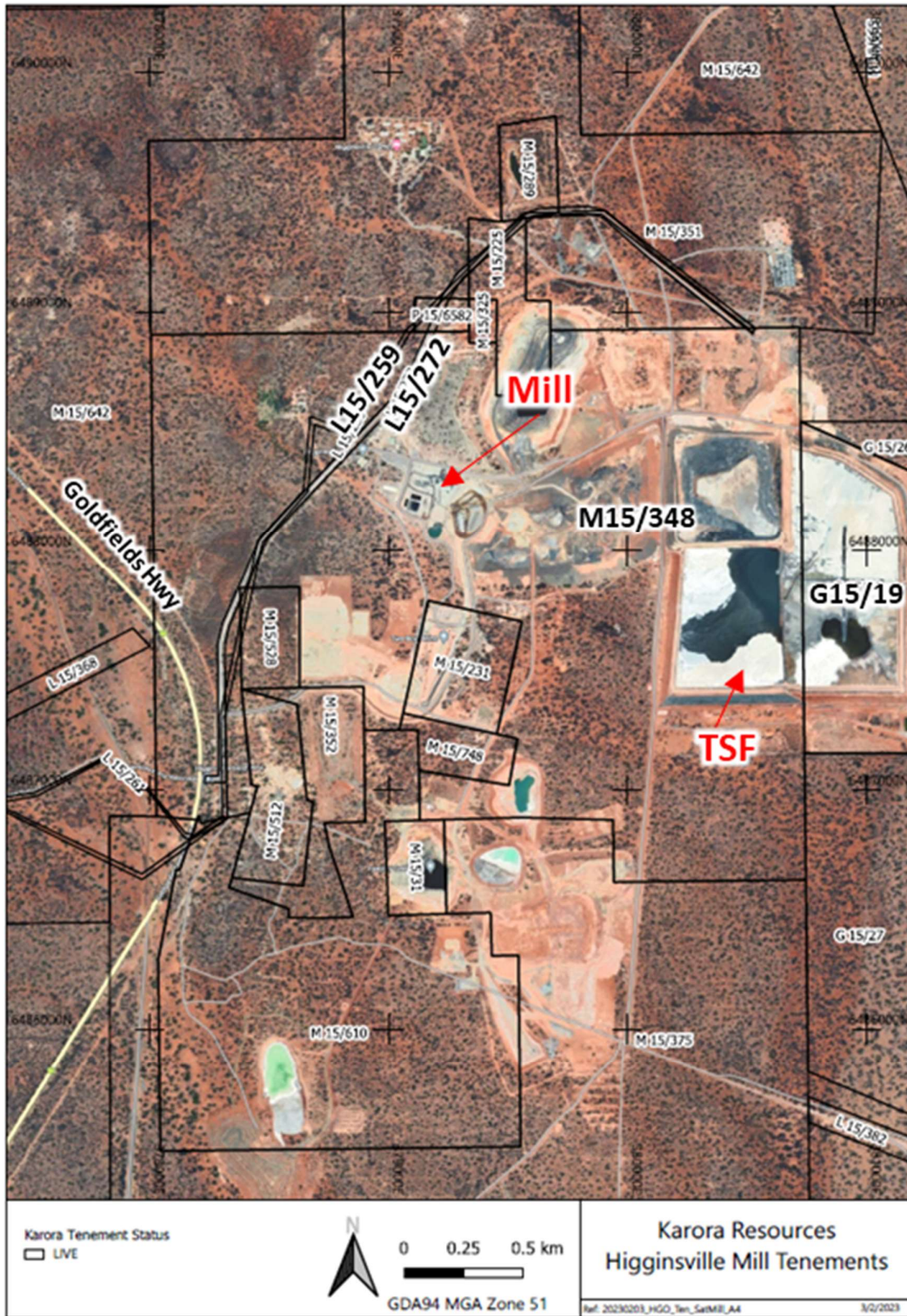

Figure 4-4 Lakewood Mill tenure map

Source: Karora



4.3 UNDERLYING AGREEMENTS

4.3.1 Lithium Rights Agreement – Liontown Resources Limited

Karora's subsidiary Avoca Resources Pty Ltd has granted exclusive rights to a wholly owned subsidiary of ASX listed Liontown Resources Limited, to explore for and mine lithium and certain associated minerals (**Liontown Lithium Rights**) on the following tenements: E63/856, P63/1977 and M63/647.

4.3.2 Lithium Rights Agreement – Kali Metals Limited

Various subsidiaries of Karora have granted Kali Metals Limited the rights to explore for and mine lithium and certain associated minerals on the majority of the Higgsinsville Regional Exploration Area, excluding the area subject to the Liontown Lithium Rights.

4.3.3 Nickel Rights Agreement – S2 Resources Limited

A wholly owned subsidiary of ASX listed S2 Resources Limited holds nickel rights on those tenements owned, wholly or partly, by Karora's wholly owned subsidiary Polar Metals Pty Ltd.

4.3.4 Nickel Rights Agreement – WA Nickel Pty Ltd

WA Nickel holds nickel rights over mining lease M15/1828, including rights to enter the tenements to explore for and mine nickel.

4.3.5 Royalties

Karora pays the following royalties on gold production:

- Production payments of up to 1% of gross gold revenue over various tenements to traditional land owners;
- Royalty equal to 2.5% of recovered gold to the Government of Western Australia; and
- Various third parties hold rights to receive royalties in respect of gold (and in some cases other minerals or metals) recovered from the tenements.

4.3.6 Joint Ventures

The following tenements are subject to a joint venture agreement that was created under the Pioneer Sale Agreement dated 9 August 2006: Exploration Licence E63/1117, Mining Leases M63/329, M63/368 and M63/660 and Prospecting Licence P63/1468.

The following tenements are subject to a joint venture agreement with Shumwari Pty Ltd: Exploration Licences E15/1458, E15/1459, E15/1464, E63/1726, E63/1727 and E63/1738.

4.4 ENVIRONMENTAL CONSIDERATIONS

Karora is responsible for satisfying all rehabilitation obligations for the HLO. Karora is required to report annually the estimated rehabilitation liability for HLO. The rehabilitation liability for the tenements associated with the Higgsinsville Mill is separate from those associated with Lakewood Mill.

Additional detail on environmental considerations is provided in Section 20.

4.4.1 Higginsville Gold Operations

At the end of Q3 2023, the estimated rehabilitation liability for Higginsville was approximately \$30M. The Higginsville rehabilitation liability estimate also includes rehabilitation following mining activities for the extraction of ore. The liability associated with the mill and tailings impoundment structures is significantly less than the liability associated with extraction activities.

4.4.2 Lakewood Operations

Karora is responsible to the regulator for satisfying all rehabilitation obligations at the Lakewood Mill since the site has been operational. The estimated rehabilitation liability for Lakewood, including all known disturbance that has occurred on the tenure, was approximately \$8.7M at the end of Q3 2023.

4.5 PERMITS AND AUTHORISATION

4.5.1 Active Mining Operations

There have been numerous Mining Proposals (MP) and Mine Closure Plans (MCP) approved and registered for HGO. An application for a Mining Lease or the proposed mining of a new deposit must be accompanied by a mineralisation report or an MP and MCP in accordance with the Mining Act. A Mining Lease, MP and MCP are required prior to carrying out mining activities on a site.

The following approvals have been issued by DMIRS to support current mining operations:

- Government of Western Australia, Department of Mines, Industrial Regulation and Safety, approval under the *Mining Act 1978* – Mining Proposal for TSF2-4 Stage Lift (Reg ID: 89038);
- Government of Western Australia, Department of Mines, Industrial Regulation and Safety, approval under the *Mining Act 1978* – Mining Proposal for Baloo & Eundynie (Reg ID: 101748);
- Government of Western Australia, Department of Mines, Industrial Regulation and Safety, approval under the *Mining Act 1978* – Mining Proposal for Spargos Reward open pit & underground (Reg ID: 113402);
- Government of Western Australia, Department of Mines, Industrial Regulation and Safety, approval under the *Mining Act 1978* – Mining Proposal for Pioneer (Reg ID: 116335); and
- Government of Western Australia, Department of Mines, Industrial Regulation and Safety, approval under the *Mining Act 1978* – Higginsville Mine Closure Plan (Reg ID: 88901).

4.5.2 Higginsville Mill

All permits required to operate the Higginsville Mill have been granted as follows:

- Government of Western Australia, Department of Mines, Industrial Regulation and Safety, approval under the *Mining Act 1978* – Mining Proposal for TSF2-4 Stage Lift (Reg ID: 89038);
- Government of Western Australia, Department of Mines, Industrial Regulation and Safety, approval under the *Mining Act 1978* – Higginsville Mine Closure Plan (Reg ID: 88901);
- Government of Western Australia, Department of Water and Environmental Regulation, license under Part V of the Environmental Protection Act 1986 – Licence for Prescribed Premises – Licence No. L9155/2018/1; and

- Government of Western Australia, Department of Water and Environmental Regulation, license under section 5C of the *Rights in Water and Irrigation Act 1914* - Licence to Take Water GWL 160795(8).

4.5.3 Lakewood Mill

All environmental permits required to operate the Lakewood Mill have been granted as follows:

- Government of Western Australia, Department of Mines, Industrial Regulation and Safety, approval under the *Mining Act 1978* – Mining Proposal for Lakewood Gold Processing Facility (Reg ID: 111925);
- Government of Western Australia, Department of Mines, Industrial Regulation and Safety, approval under the *Mining Act 1978* – Lakewood GPF Closure Plan (Reg ID: 111925);
- Government of Western Australia, Department of Water and Environmental Regulation, license under Part V of the *Environmental Protection Act 1986* – Licence for Prescribed Premises – Licence No. L9124/2018/1; and
- Government of Western Australia, Department of Water and Environmental Regulation, license under section 5C of the *Rights in Water and Irrigation Act 1914* - Licences to Take Water GWL 203328(2) and GWL 203329(2).

4.6 MINING RIGHTS IN WESTERN AUSTRALIA

4.6.1 Mining Tenements

Under section 9 of the Mining Act, all gold, silver, other precious metals, and other minerals on or below the surface of the land are generally the property of the Crown. In Western Australia, a Mining Lease is the primary approval required for major mineral development projects and mining activities as it authorises the holder to mine for, and dispose of, minerals on the land over which the lease is granted.

The holder of a Mining Lease may work and mine the land, take and remove minerals and do all acts and things necessary to effectually carry out mining operations in, on or under the land, subject to conditions of the Mining Lease and certain other exceptions under the Mining Act.

The term of a Mining Lease is 21 years and may be renewed for further terms.

In addition to Mining Leases, other types of mining tenements granted under the Mining Act, and held by subsidiaries of Karora for the purposes of exploration and mining activities include exploration licences, prospecting licences, miscellaneous licences and general purpose leases.

The HLO mining tenements are active and in good standing at the effective date of this Technical Report (Table 4-1).

4.6.2 Native Title Act 1993

In 1992, the High Court of Australia determined in *Mabo v Queensland (No. 2)* that the common law of Australia recognised certain proprietary rights and interests of Aboriginal and Torres Strait Islander people in relation to their traditional lands and waters. In response to the Mabo decision, the *Native Title Act 1993* (Cth) was enacted in an attempt to codify the implications of the decision and establish a legislative regime under which Australia's Indigenous people could seek to have their native title rights recognised. Native title is recognised where persons claiming to hold that title can establish they have maintained a continuous connection with the land in accordance with traditional laws and customs since settlement and where those rights have not been lawfully extinguished.

The Native Title Act codifies much of the common law in relation to native title. The doing of acts after January 1, 1994 that may affect native title (known as 'future acts'), including the grant of mining tenements, are validated subject to certain procedural rights (including the 'right to negotiate') afforded to persons claiming to hold native title and whose claim has passed a 'registration test' administered by the National Native Title Tribunal (which assesses the claim against certain baseline requirements).

The HGO tenements are subject to native title determinations and claims.

As of the date of this Technical Report, the status of Native Title determinations with respect to the HLO tenements is as follows:

- Ngadju Claim (WCD2014/004, WAD6020/1998) and Ngadju B Claim (WCD2017/002, WAD6020/1998): the Federal Court of Australia has determined that the Ngadju people have native title rights and interests in relation to an area of land that includes a large number of the HGO tenements.
- Marlinyu Ghoorlie Claim (WC2017/007, WAD647/2017): the Federal Court has accepted for registration a claim by the Marlinyu Ghoorlie people over an area of land that includes a number of HGO tenements. This claim has not yet been determined.

Applicable legislation contains provisions that may make a tenement holder liable for the payment of compensation for the effect of mining and exploration activities on native title rights and interests.

Karora has inherited three mining agreements with native title groups for the grant of tenements:

- 2002 Mining Agreement: with the Ngadju People dated May 20, 2002;
- 2013 Mining Agreement: with the Ngadju People a dated January 1, 2013; and
- 2018 Mining Agreement: with Ngadju Native Title Aboriginal Corporation RNTBC, dated June 12, 2018.

4.6.3 Aboriginal Heritage Act 1972

The *Aboriginal Heritage Act 1972 (WA)* (AHA) protects places and objects that are of significance to Aboriginal and Torres Strait Islander people in accordance with their traditional laws and customs (Aboriginal Sites). The AHA provides that it is an offence for a person to damage or in any way alter an Aboriginal Site.

Compliance with the AHA is an express condition of all mining tenements in Western Australia. Accordingly, commission of an offence under the AHA may mean that the mining tenement is vulnerable to an order for forfeiture.

The Department of Planning Lands and Heritage (DPLH) Aboriginal Cultural Heritage Inquiry System (AHIS) provides details about certain registered Aboriginal Sites.

A search of the AHIS conducted on January 4, 2024 shows there are a number of Aboriginal Sites within the HGO tenements. Based on records held by HGO, prior to the area being developed and mined, ethnographic and archaeological surveys were commissioned over HGO tenements. No sites of ethnographic or archaeological significance were recorded that would be impacted by Karora's operations.

Specific to LKO, a desktop search of the AHIS for the Lakewood Mill tenements was undertaken and listed Aboriginal Sites and Other Heritage Places located within the tenements. According to the AHIS, there have been two recorded ethnographic surveys and one archaeological survey

which covered the mining lease areas. The buffer areas of two registered Aboriginal Sites intersect with L26/234. No disturbance to these Aboriginal Sites is planned to be undertaken by Karora.

Karora is a party to a number of heritage protection and mining agreements that impact the HLO tenements and require additional heritage surveys to be undertaken prior to certain activities being undertaken.

5 ACCESSIBILITY, LOCAL RESOURCES, INFRASTRUCTURE, CLIMATE AND PHYSIOGRAPHY

5.1 ACCESSIBILITY

5.1.1 Higginsville Mill

The mill is adjacent to a major highway connecting the Goldfields towns of Coolgardie and Norseman. Higginsville is located in the Coolgardie Mineral Field in the Shire of Coolgardie, approximately 55 km north of Norseman and 50 km south of Kambalda by sealed road.

Figure 5-1 shows the access to the mill and offices via a constructed all-weather access road (0.8 km) from the Goldfields Highway.

Figure 5-1 Higginsville Mill access - oblique aerial view

Source: Karora



5.1.2 Lakewood Mill

The Lakewood Mill is located approximately 4 km southeast of the City of Kalgoorlie-Boulder, the nearest occupied townsite (Figure 4-1), and 65 km north of Beta Hunt by sealed road.

Lakewood is located within a historical gold treatment area adjacent to the famous Golden Mile. The site and its immediate surrounds have been subject to extensive historic disturbance from the early 1900s including timber cutting, townsite development, mining and tailings stockpiling.

The main access to the mill is from the Goldfields Highway via the public Mount Monger Road and gazetted Lakewood Gold Processing Facility Access Road. The Mount Monger Road (and Road Reserve) is located within tenements L26/234 and M26/242. Part (61.42%) of tenement L26/234 is located on the Woolibar Pastoral Station (Pastoral Lease N050022), and the Woolibar Pastoral Station Homestead is more than 25 km south of the mill.

5.2 LOCAL RESOURCES AND INFRASTRUCTURE

Kambalda has been a major nickel mining centre since the discovery of nickel sulphides by WMC in 1966. Kambalda (East and West) has a population of 2,465 (2021 Census) and is serviced from the regional hub of Kalgoorlie-Boulder, which has a population of 29,306 (2021 Census). Norseman has a population of 562 (2021 Census).

Gold was first discovered at Norseman in 1894 and was once the second-richest goldfield in Western Australia after the Golden Mile of Kalgoorlie.

There is a long history of mining in the district with a large pool of experienced mining personnel living and working in the region. The current workforce of 77 persons are mostly FIFO workers from Perth who arrive at site by bus from Kambalda Airport. Karora runs charter flights from Perth to the Kambalda Airport on Tuesdays and Thursdays, with capacity for the entire FIFO workforce. The FIFO workers are supplemented by workers who reside in regional towns such as Norseman, Kambalda, Kalgoorlie and Esperance.

The Kambalda Airport provides daily chartered flights, five days a week, to the state capital of Perth. Perth is a major centre with a population in excess of 2 million and an international airport.

The Lakewood Operations has a residential workforce of 22 persons and is located on the edge of Kalgoorlie-Boulder.

5.3 CLIMATE

The Kambalda, Higginsville and Lakewood areas experience a semi-arid climate with hot dry summers and cool winters. All three locations fall within the Kalgoorlie Province bioclimate which is described as mainly Sub-Eremaean. This is mostly a semi-desert Mediterranean climate with 9–11 dry months each year. Temperatures in the peak of summer typically range from a mean minimum temperature of 15°C to a mean maximum of 34°C. Temperatures during winter range from a mean minimum temperature of 6°C to a mean maximum of only 17°C, with occasional frosts.

Kambalda and Higginsville receive a mean annual rainfall of approximately 260 mm, although this is highly variable with records indicating dry years receiving only half that rainfall and wet years receiving up to twice the mean annual rainfall. The region experiences its driest period of the year from spring to early summer, and the wettest period of the year in autumn and winter.

The region experiences a very high annual evaporation rate of 2,700 mm in Kalgoorlie and 1,780 mm in Norseman.

5.4 PHYSIOGRAPHY

5.4.1 Higginsville Mill

The mill lies within the Great Western Woodland, an area of great biological richness that extends over 16 Mha. It is regarded as the largest remaining area of intact Mediterranean climate woodland left on earth and contains about 3,000 species of flowering plants, one fifth of the known flora in Australia (SRK, 2010). Although still essentially intact, the Great Western Woodlands is under increasing pressure from feral animals, weeds, and wildfires and if not effectively managed, these influences could seriously degrade or even destroy natural and cultural values in the area. In 2013, the Department of Biodiversity, Conservation and Attractions (DBCA, then the Department of Environment and Conservation) released the 'Great Western Woodlands Draft Strategic Weed and Feral Animal Management Plan' to identify and map

priority weed and pest animal populations in the woodlands and determine the most cost-effective means of control.

5.4.2 Lakewood Operations

The Lakewood Operations is within the Eastern Goldfields (COO03) sub-bioregion as defined by the Interim Biogeographic Regionalisation for Australia (IBRA) classification system, and also lies within the Great Western Woodlands. Information below is based on a report prepared by Botanica Consulting for Karora Resources (Botanica, 2023).

5.4.2.1 Landscape

Lakewood Operations is located within the Kambalda soil-landscape Zone (265). This zone is characterised by flat to undulating plains (with hills, ranges and some salt lakes and stony plains) on greenstone and granitic rocks of the Yilgarn Craton. Soils comprise Calcareous loamy earths and red loamy earths with salt lake soils and some red-brown hardpan shallow loams and red sandy duplexes (Tille, 2006). The LKO soil landscape is dominated by gentle undulating valley plains and pediments and some outcrop of basic rock. Around 0.4 ha of the northwest corner of tenement M40/242 extends into rocky ranges and hills of greenstones-basic igneous rocks. Part of the borefield tenement (L26/234) also extends into salt lakes and their associated areas.

5.4.2.2 Vegetation

The surrounding vegetation consists of Mallees, Acacia thickets and shrub-heaths on sandplains. Diverse eucalypt woodlands occur around salt lakes, on ranges and in valleys. Salt lakes support dwarf shrublands of samphire. Woodlands and Dodonaea shrubland occur on basic graninulites of the Fraser Range. The area is rich in endemic Acacias (Cowan, 2001).

6 HISTORY

6.1 PRE-WESTGOLD

The pre-2006 history text is taken from the Higginsville Feasibility Study (Avoca, 2006):

“Samantha Gold NL commenced exploration activities in and around the historic mining centres of Higginsville and Eundynie in 1983 after acquiring ground from local prospectors. From 1987 to 1993 extensive use of soil geochemistry led to the early discovery of the Poseidon South, Graveyard and Aphrodites’ deposits and later the Tertiary sediment hosted Challenger-Swordsman deep-lead deposit.

Resolute gained control of Samantha in July 1994 and continued an intensive exploration approach that yielded additional discoveries. In 1996 exploration focus changed to examining the depth potential of the Higginsville Belt. Deep drilling was undertaken to test down dip of the Poseidon South deposit. Underground mining from the base of the Poseidon South Pit was undertaken from 1997 to 1998. From 1989 to 1997, the Higginsville gold plant processed a total of 6.7M tonnes to produce 613,000oz.

In July 1999, WMC Resources Ltd. (WMC) entered into a joint venture with Resolute to explore the Project area for nickel and gold. Gold Fields Australasia (GFA) purchased WMC’s interest in the project as a part of the Sale and Purchase Agreement for WMC’s Western Australian gold assets in November, 2001, and acquired interest in the Higginsville Joint Venture on February 22, 2002. GFA took over full control of the Project in October, 2003 with Resolute retaining the nickel rights (subsequently sold to Bullion Minerals Limited). Over the period of WMC’s involvement in the Project, the ground holding has reduced by over 50%, from 400 km² to 178 km².

Avoca Resources Ltd (Avoca) reached agreement with Gold Fields to acquire 100% of the Higginsville Gold Project on 30 June 2004, with subsequent settlement occurring on 3 December 2004. The Nickel rights to particular tenements are held by Bullion. Equinox commenced a joint venture arrangement with Bullion on these tenements to explore for nickel (the Cowan Nickel Joint Venture). Bullion subsequently transferred the nickel rights to Lione Resources Limited.

Avoca discovered the Trident Deposit in October 2004, with an initial resource statement of 450,000oz completed in August 2005. A pre-feasibility study was completed in December 2005. Additional drilling resulted in an updated resource statement released in May (to 870,000 oz) and August 2006 (to 1.1 M ounces). The Trident Proved and Probable Mineral Reserve, based on the Trident Feasibility Study, was 3,394 kt @ 5.3 g/t for 581,000 oz.”

Underground development at Trident commenced in early 2007, and the first high grade ore was mined from Trident in August, 2007.

The procurement and construction of a new 1 Mtpa CIL processing plant at Higginsville commenced in late 2007. The plant was commissioned in the first half of 2008 with the first official gold pour on July 1, 2008 (Figure 6-1). The plant was designed to treat 1.3 Mtpa. The Trident mine was the base load of the operation, supplemented by feed coming from paleochannels and open pits. A paste plant delivering paste to the underground was completed in October 2009.

Figure 6-1 Higginsville Mill (2008)

Source: Westgold



The Trident underground mine produced 7,434,000 t @ 4.4 g/t Au for 1,045,000 oz of gold up to December 4, 2016 when the mine closed.

On February 18, 2011, Anatolia Minerals Development Limited (Anatolia) and Avoca merged, resulting in a new company called Alacer Gold Corp. (Alacer).

6.2 WESTGOLD RESOURCES

On October 1, 2013, Metals X Limited (Metals X) acquired the whole of Alacer's Australian gold operations on a going concern basis through its wholly owned subsidiary, Westgold Resources Limited. The acquisition included HGO. During this time until June 10, 2019, HGO produced 5,484,406 t @ 2.5 g/t for 441,493 oz (excluding production from third party toll milling).

In July 2015, Metals X acquired the Mt Henry Gold Project from Panoramic Resources Ltd (Panoramic) and Matsa Resources Limited. The Mt Henry Gold Project is located approximately 15 km south of Norseman and 75 km south of the HGO. The Mt Henry Gold Project consists of three known deposits: North Scotia, Selene and Mt Henry. All the deposits are located on granted mining leases. At the date of acquisition, the deposits had an aggregate JORC Code total resource of 1.656 Moz (43.18 Mt @ 1.19 g/t Au using a 0.4 g/t Au cut-off).

In February 2018, Westgold acquired the Polar Bear and Norcott Projects, together with the Eundynie Joint Venture, for A\$9M from S2 Resources Limited (S2); S2 retained nickel rights.

The Polar Bear Project abuts the main Higginsville historic gold deposits and provides short-term ore for the Higginsville mill from the Baloo deposit. Exploration prospects with a view to development are at the nearby Monsoon, Bindy, Nanook and Ear Lobe deposits. A Mineral Resource estimate of 4,220,000 t grading 2.0 g/t gold for a contained 264,000 oz of gold was announced by S2 in February 2017.

On October 2, 2018, Westgold published a gold Mineral Resource estimation and Mineral Reserve update effective June 30, 2018 (www.westgold.com.au). This historical Mineral Resource is presented in Table 6-1 and historical Mineral Reserve is presented in Table 6-2.

Table 6-1 HGO Historical Gold Mineral Resources as at June 30, 2018.

Source: Karora

Project	Measured			Indicated			Inferred			Total		
	Tonnes ('000s)	Grade	Oz Au ('000s)	Tonnes ('000s)	Grade	Oz Au ('000s)	Tonnes ('000s)	Grade	Oz Au ('000s)	Tonnes ('000s)	Grade	Oz Au ('000s)
Trident	620	3.8	75	571	5.2	96	714	4.51	104	1904	4.48	275
Chalice	266	4	35	501	3.6	57	186	4.15	25	953	3.80	116
Corona - Fairplay	2	-	0	944	2.3	69	282	2.95	27	1,228	2.42	96
Vine	-	-	-	190	2.1	13	468	2.04	31	658	2.07	44
Lake Cowan	71	1.6	4	1,191	1.5	58	528	1.34	23	1,790	1.47	85
Two Boys	-	-	-	375	2.0	25	203	2.88	19	578	2.33	43
Mt Henry	1,301	1.9	79	8,147	1.7	453	898	1.83	53	10,347	1.76	584
Paleochannels	-	-	-	1,474	2.2	102	208	2.13	14	1,682	2.15	116
Greater Eundynie	-	-	-	-	-	-	683	1.86	41	683	1.86	41
Polar Bear	-	-	-	1,160	1.9	71	5260	1.67	282	6,240	1.71	353
Musket	107	2.3	8	376	2.3	28	601	1.60	31	1,084	1.92	67
Other	-	-	-	485	1.5	24	603	1.72	33	1,087	1.64	57
Stockpiles	751	0.9	21	258	1.0	8	-	-	-	1,009	0.89	29
Total	3,118	2.20	220	15,672	2.0	1,004	10,634	1.99	681	29,424	2.01	1,906

- 1) Rounded for reporting.
- 2) The Baloo Deposit is included in the Polar Bear Project.

Table 6-2 HGO Historical Gold Mineral Reserves as at June 30, 2018

Source: Karora

Project	Proven			Probable			Total		
	Tonnes ('000s)	Grade	Oz Au ('000s)	Tonnes ('000s)	Grade	Oz Au ('000s)	Tonnes ('000s)	Grade	Oz Au ('000s)
Trident	-	-	-	-	-	-	-	-	-
Chalice	-	-	-	-	-	-	-	-	-
Corona – Fairplay	-	-	-	286	2.91	27	286	2.91	27
Vine	-	-	-	-	-	-	-	-	-
Lake Cowan	-	-	-	132	1.97	8	132	1.97	8
Two Boys	-	-	-	57	2.12	4	57	2.12	4
Mt Henry	-	-	-	3,236	1.79	186	3,236	1.79	186
Paleochannels	-	-	-	924	2.06	61	924	2.06	61
Greater Eundynie	-	-	-	-	-	-	-	-	-
Polar Bear	-	-	-	707	1.87	43	707	1.87	43
Musket	-	-	-	244	2.42	19	244	2.42	19
Other	-	-	-	193	1.66	10	193	1.66	10
Stockpiles	29	3.63	3	136	1.27	6	164	1.68	9
Total	29	3.63	3	5,916	1.91	363	5,945	1.92	367

- 1) Rounded for reporting.

- 2) The information is extracted from the report entitled '2018 Annual Update of Mineral Resources & Ore Reserves' dated on October 2, 2018 and is available to view on Westgold Resources Ltd's website (www.westgold.com.au) and the ASX (www.asx.com.au). Mineral Resources are quoted inclusive of Ore Reserves.

6.3 KARORA RESOURCES

In June 2019, Karora acquired the Higginsville Gold Operations, including the mill. Modifications to the plant under Karora ownership include crusher product size optimization, larger cyclone feed and tails pumps, larger gravity screen and improved cyclone classification. The plant is now designed to treat up to 1.6 Mtpa.

In August 2020, Karora acquired the Spargos Reward Gold Project from Corona Resources Limited. The project contained an historical JORC Code Mineral Resource Estimate of 112,000 oz (785,800 t @ 4.4 g/t Au) Indicated Resource and 19,000 oz (151,000 t @ 4.0 g/t Au) Inferred Resource (Karora, 2020).

On December 16, 2020, Karora announced Mineral Resources and Reserves for Higginsville (and Beta Hunt) effective as of September 30, 2020. The Mineral Resources and Reserves for HGO represented the initial reporting of Mineral Resources and Reserves in accordance with NI 43-101 guidelines and under Karora's ownership (Table 6-3 and Table 6-4).

Table 6-3 Higginsville Gold Mineral Resources as of September 30, 2020

Sep. 2020 Mineral Resource	Measured			Indicated			Measured & Indicated			Inferred		
	kt	g/t	koz	kt	g/t	koz	kt	g/t	koz	kt	g/t	koz
HGO Central	953	3.0	91	3,266	2.8	291	4,219	2.8	382	1,455	3.1	145
HGO Greater	12,234	1.3	508	12,094	1.4	540	24,328	1.3	1,048	3,126	1.6	165
Stockpiles	175	0.8	5	1,273	0.7	30	1,448	0.7	35	-	-	-
Total	13,362	1.4	604	16,633	1.6	862	29,994	1.5	1,466	4,581	2.1	310

Table 6-4 Higginsville Gold Mineral Reserves as of September 30, 2020

Sep. 2020 Mineral Reserve	Proven			Probable			Proven & Probable		
	kt	g/t	koz	kt	g/t	koz	kt	g/t	koz
HGO Central	226	2.3	17	2,991	2.0	193	3,216	2.0	210
HGO Greater	573	2.0	36	13,149	1.4	586	13,722	1.4	622
Stockpiles	175	0.8	5	778	0.8	21	953	0.8	25
Total	973	1.8	57	16,918	1.5	800	17,891	1.5	857

On April 7, 2022 Karora announced updated Mineral Resources for Higginsville (and Beta Hunt) effective as of January 31, 2022. (Table 6-5). The updated Mineral Resources included two new resources at Aquarius and Spargos.

Table 6-5 Higginsville Gold Mineral Resources as of January 31, 2022

Jan. 2022 Mineral Resource	Measured			Indicated			Measured & Indicated			Inferred		
	kt	g/t	koz	kt	g/t	koz	kt	g/t	koz	kt	g/t	koz
HGO Central	847	3.1	85	3,380	2.8	307	4,227	2.9	392	1,724	3.1	172
HGO Greater	12,224	1.3	514	12,882	1.5	624	25,106	1.4	1,137	4,647	1.7	256
Stockpiles	2,378	0.8	58				2,378	0.8	58			
Total	15,449	1.3	657	16,262	1.8	930	31,711	1.6	1,587	6,372	2.1	428

In July, 2022, Lakewood Mining Pty Ltd (a fully owned subsidiary of Karora Resources) acquired the operating, fully permitted 1.0 Mtpa Lakewood Mill from Golden Mile Milling Pty Ltd (GMM) for an acquisition price of A\$80 million. The mill is located near Kalgoorlie, Western Australia, approximately 60 km from the Beta Hunt Mine. The mill (Figure 6-2) has the capacity to process gold ore from both the Beta Hunt and Higginsville Operations. Karora has an approved Works Approval (W6719/2022/1) for the installation of a Dunford regrind mill and the construction of TSF 2, raising the production rate to 1.2 Mtpa.

Figure 6-2 Lakewood Mill (2022)

Source: Karora



Since Karora's acquisition on June 10, 2019, HGO has mined 2.6 Mt of gold mineralisation at average grade of 2.2 g/t Au (186 koz contained gold) to September 30, 2023. Gold was mined from the Baloo, Fairplay North, Mouse Hollow, Hidden Secret and Spargos open pits, and the Aquarius and Two Boys underground mines.

7 GEOLOGICAL SETTING AND MINERALISATION

7.1 REGIONAL GEOLOGY

The following geological descriptions are summarised from the Westgold Annual Mineral Resource Commentary (Westgold, 2018). The Higginsville Gold Operations is located in the Eastern Goldfields Superterrane (Cassidy et al., 2006) of the Archean Yilgarn Craton of Western Australia (Figure 7-1). The Eastern Goldfields Superterrane is comprised of metavolcanic and metasedimentary rocks, granites and granitic gneiss, and is divided into a number of terranes, namely the Kalgoorlie, Kurnalpi and Burtville Terranes. These tectono-stratigraphic terranes are defined on the basis of distinct volcanic facies, geochemistry and geochronology with the Eastern Goldfields Superterrane, and range in age from 2.81 Ga to 2.66 Ga.

Figure 7-1 Greenstone belts within the Yilgarn Craton

Source: Karora

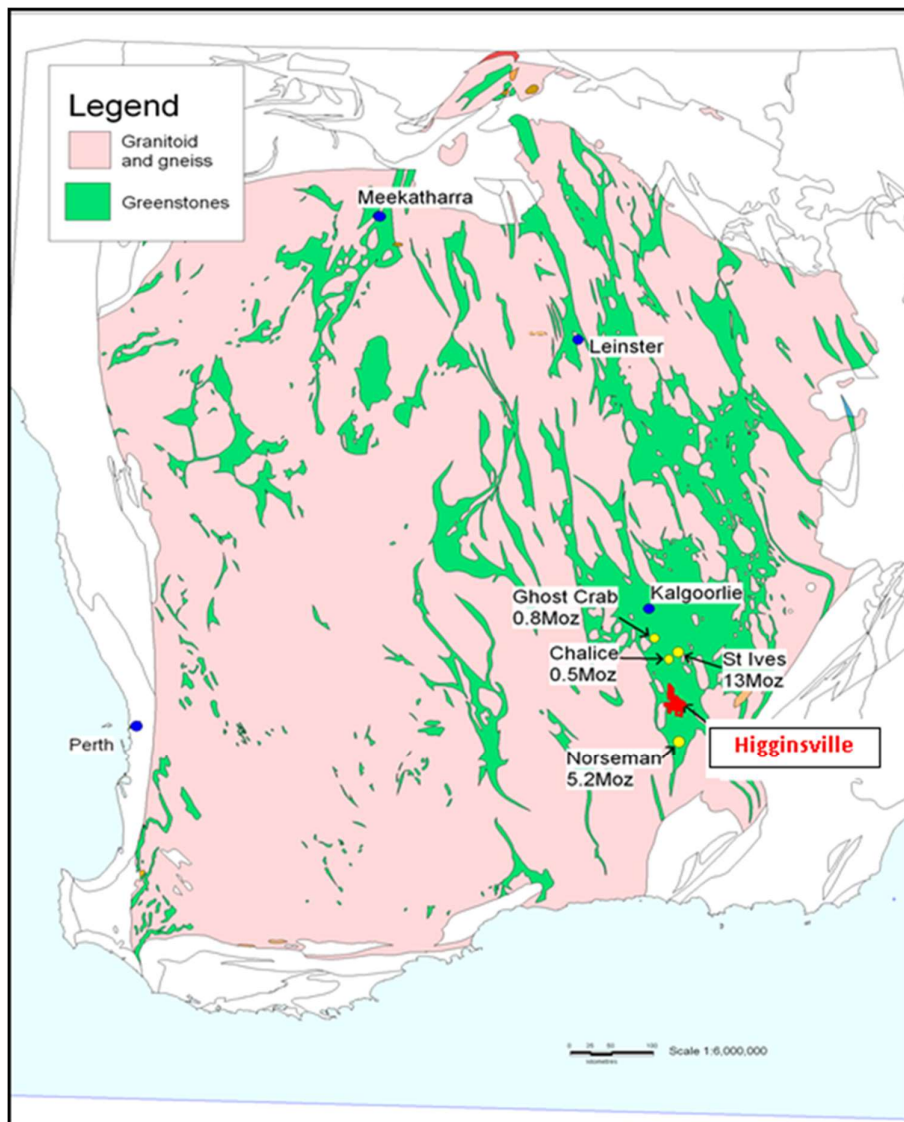

The bulk of the Higginsville tenement package is located almost entirely within the well-mineralised Kalgoorlie Terrane, between the gold mining centres of Norseman and St Ives. This region is made up predominantly of younger (2.71–2.66 Ga) and minor older (>2.73 Ga) greenstone successions.

The structurally complex Archaean geology is rarely observed in outcrop, being obscured by well-developed ferruginous and carbonate soils, aeolian sands, tertiary palaeo-sediments and salt lake sediments. Many areas are also overprinted by deep lateritic profiles, which have resulted in extensive chemical remobilisation and deposition. The Archaean stratigraphy has a general northward trend comprising multiply deformed ultramafic-gabbro-basalt successions adjoined by sediments to the west and east. Shearing and faulted contacts are common. The units have been structurally repeated by east-over-west thrust faulting.

Greenstone rocks of the Norseman region can be broadly correlated with the Kalgoorlie-Kambalda region in that they form a distinct lithology which is bounded on all sides by major regional shears. Higginsville geology is covered by the Norseman and Kambalda Domains (Figure 7-2).

Figure 7-2 Stratigraphic relationships of the principal mafic-ultramafic units of the Kalgoorlie Terrane
Source: Hayman (2015)

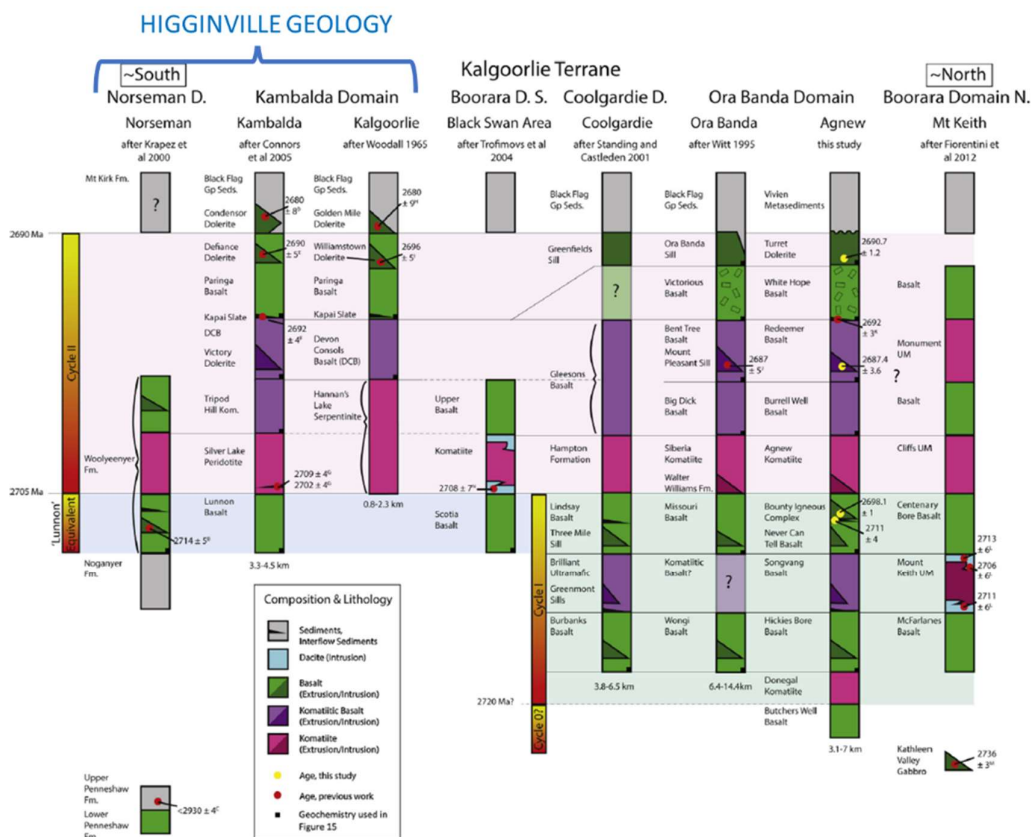

The Norseman Terrane has prominent Banded Iron Formation (BIF), which distinguishes it from the Kalgoorlie-Kambalda lithology.

The Archean rocks in the Norseman area have been classified into the following series of formations:

- The Penneshaw Formation forms the greenstone sequence on the eastern side of the belt. It consists of mafic volcanic rocks with interlayered units of felsic volcanoclastic and sedimentary rocks, and is intruded by doleritic sills and dykes. This formation is intruded by the Buldania Granite complex in the east and is structurally overlain by the Noganyer Formation in the west.
- The Noganyer Formation forms a distinct sedimentary sequence of siliclastic rocks, principally silicate facies BIF, chert, sandstone and shales. Intrusion of dolerite dykes and sills are common throughout. The Mt Henry and Selene gold deposits are hosted in the Noganyer Formation. This formation is conformably overlain by the Woolyeenyer Formation.
- The Woolyeener Formation both dips and faces west and consists of a sequence of mafic volcanic rocks with minor ultramafics and sedimentary units. Syn-volcanic dolerite dykes and sills intrude the strata and Noganyer Formation below. This formation hosts the Norseman style quartz reef gold mineralisation as well as the Abbotshall gold deposit which is hosted in a regionally extensive porphyry/siliceous sedimentary unit of the Woolyeenyer Formation. It is unconformably overlain by the Mount Kirk Formation.
- The Mount Kirk Formation consists of felsic volcanic and sedimentary rocks which are intruded by large, thick mafic sills. The Mount Kirk Formation is bounded to the west by a granite-gneiss complex. No gold deposits have been found in the Mount Kirk Formation.

Intrusive rocks in the Norseman area comprise the following:

- Large external granitoid complexes that bound the greenstone belt to the southeast and southwest;
- A suite of domal granites and porphyry that intrude the western granitoid complex and the Woolyeenyer Formation;
- Stocks of potassic granite and associated pegmatite; and
- Proterozoic dolerite dykes that intrude sets of east-west fractures in the craton.

The solid rock geology is overlain by Quaternary and Tertiary sediments, comprising aeolian dune deposits, alluvium and colluvium. These include Tertiary Wollubar Sandstone which forms the basal sand within the palaeochannels. These are overlain by silts and clays of the Perkolilli Shale, which outcrop under Lake Dundas and the greater Lake Cowan palaeochannel system.

7.2 MINERALISATION (BY GEOLOGICAL DOMAIN)

HGO can be subdivided into seven major geological domains:

- Trident Line-of-Lode;
- Chalice;
- Lake Cowan;
- Southern Palaeochannels;
- Mt Henry;
- Polar Bear Group; and
- Spargos Project Area.

7.2.1 Trident Line-of-Lode

The majority of mineralisation projects along the Trident Line-of-Lode are hosted within the Poseidon Gabbro and high-MgO dyke complexes in the south (Figure 7-3). The Poseidon Gabbro is a thick, weakly-differentiated gabbroic sill, which strikes north-south and dips 60° to the east, is over 500 m thick and 2.5 km long.

Figure 7-3 Deposits along the Trident Line-of-Lode

Source: Karora

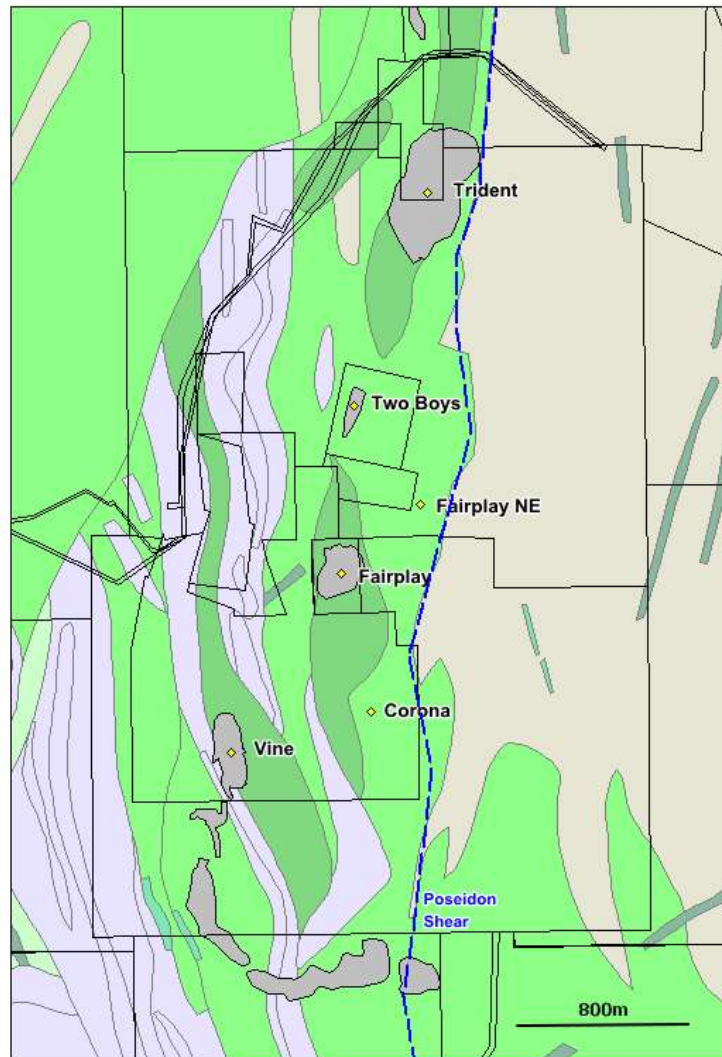

The gabbro is broadly zoned (Zones 1–5), with Zone 3 considered the most favourable for mineralisation:

- Zone 1 is interpreted as an ultramafic cumulate base;
- Zone 2 is a feldspar-phyric mafic unit;
- Zone 3 is an equigranular, feldspar-quartz phyric unit;
- Zone 4 is a bladed amphibole unit; and
- Zone 5 is an equigranular, feldspar-amphibole phyric unit.

Faulting and shearing are important geological features in the region, with the Poseidon Thrust comprising a 5 m to 10 m wide mylonite zone, which marks the contact between the eastern sedimentary packages of the Black Flag Beds and the underlying Paringa Basalt.

A number of shallow, east-dipping, reverse fault zones have also been intersected in both the Trident underground mine and the Poseidon open pit. These structures vary in thickness between 5 m and 50 m, and are generally moderately to well mineralised. Vertical to sub-vertical

(steep east and steep west-dipping), north to northeast striking shear zones are evident throughout the Trident deposit, and are thought to form a primary control and fluid source for mineralisation.

In the south, deposits such as Fairplay North and East, and Corona are hosted by high-Mg basalts which strike north-south and dip at 50° to 60° to the east. Thrust over the basalts are thick sequences of metasediments (Black Flag Beds) comprising fine grained, laminated to massive epiclastics tending to be more arenaceous and quartz rich to the east.

The mineralisation is hosted within or marginal to quartz veining and is structurally and lithologically controlled. Veins occur on and adjacent to the thrust contact and may be up to 3 m in width and lie preferentially in the basalt host. Alteration consists of silica flooding which has obscured older textures; locally intense biotite alteration within the basalts closely associated with the silicification and arsenopyrite alteration is common and locally intensified with the quartz veining and silica-biotite alteration. Laterisation and erosion have resulted in supergene enrichment within the transitional layer following downward surface water leaching of the upper saprolite.

7.2.2 Chalice

The Chalice Deposit is located within a north-south trending, 2 km to 3 km wide greenstone terrane, flanked on the west calc-alkaline granitic rocks of the Boorabin Batholith and to the east by the Pioneer Dome Batholith. The mafic-ultramafic rocks of the greenstone terrane comprise upper greenschist to middle amphibolite facies metamorphosed, high-magnesium basalt, minor komatiite units and interflow clastic sedimentary rocks intruded by a complex network of multi-generational granite, pegmatite and porphyry bodies (Figure 7-4).

Figure 7-4 Simplified Geology of the Chalice Pit (left) Plan View, (right) Section view looking north
Source: Karora

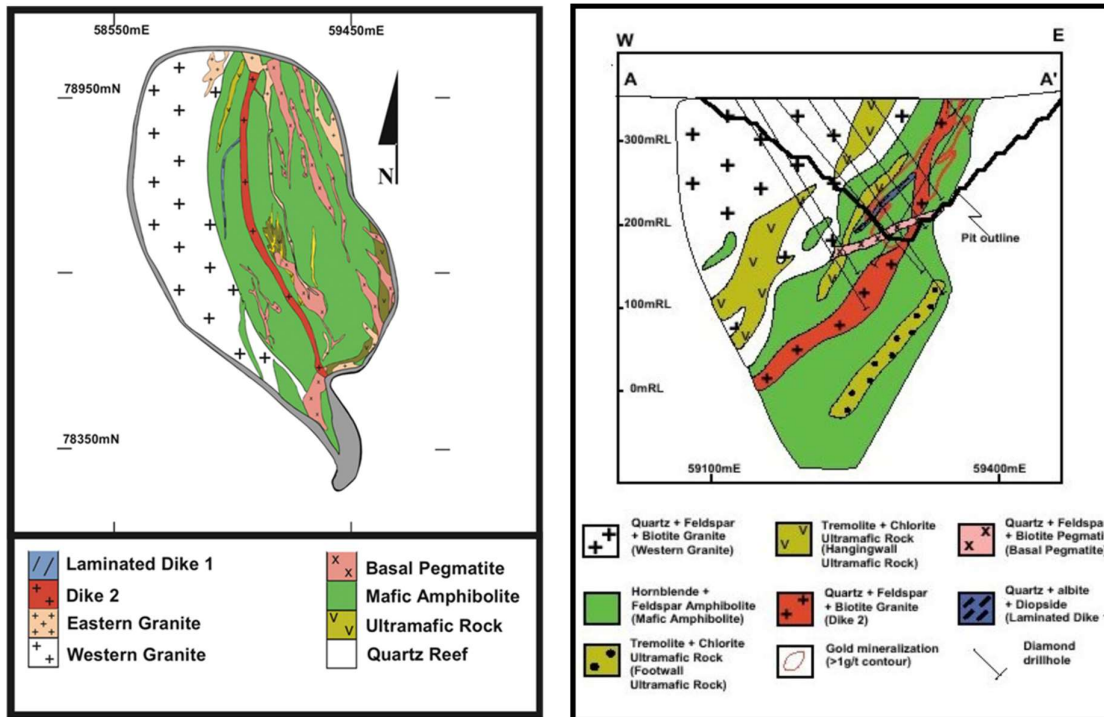

The dominant unit that hosts gold mineralisation is a fine grained, weak to strongly foliated amphibole-plagioclase amphibolite, with a typically lepidoblastic (mineralogically aligned and banded) texture. It is west-dipping and generally steep, approximately 60° to 75°. It is typically more competent than the ultramafic unit. The amphibolite is of basaltic derivation, with alteration and the metamorphic grade generally increasing markedly towards the main mineralisation zone.

7.2.3 Lake Cowan

The Lake Cowan Project is located on the northwest shore of the Lake Cowan salt pan, 19 km northeast of the historic Higgsville town site.

The area is situated near the centre of a regional anticline between the Zuleika and Lefroy faults, with the local geology of the area made more complex by the intrusion of the massive Proterozoic Binneringie dyke (Figure 7-5). The anticlinal system is in a rift-phase portion of the greenstone belt, comprising a complex succession of mafics and ultramafics, sulphidic carbonaceous shales, felsic volcanics and volcanoclastic sediments. These have been intruded by several younger felsic granitoids.

Figure 7-5 Deposits within the Lake Cowan Project

Source: Karora

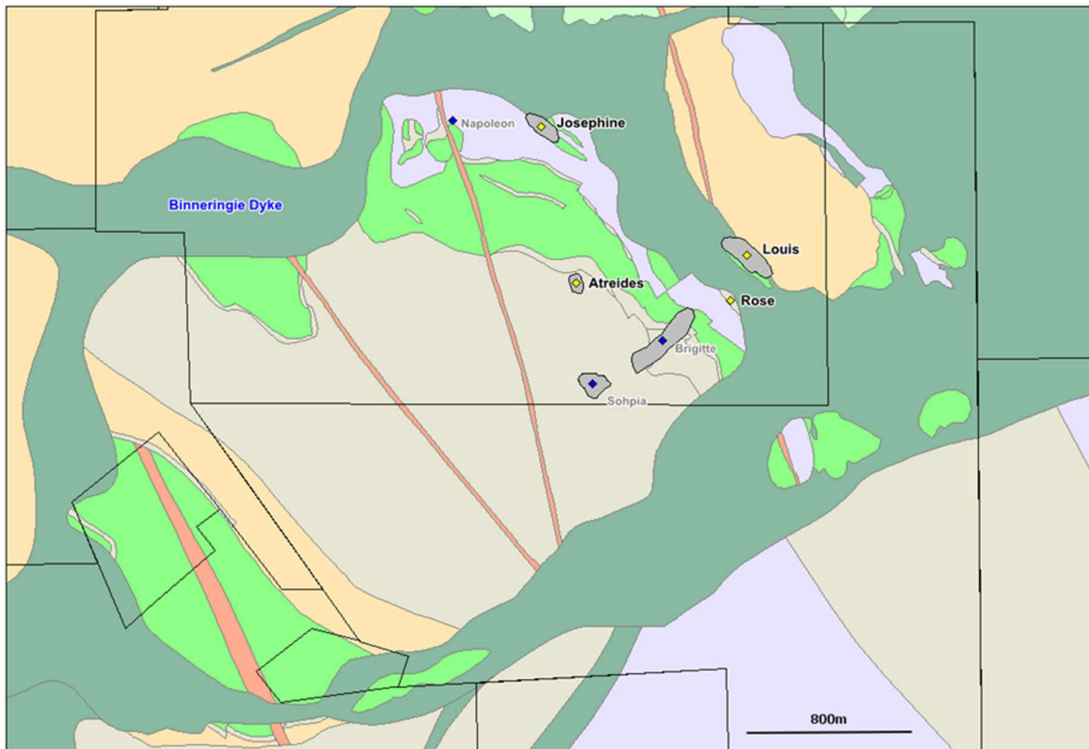

The area is interpreted to have undergone intense intraformational folding and transposition, and has a metamorphic grade estimated to be upper greenschist facies with local hornfelsing proximal to the Binneringie dyke.

The Binneringie dyke varies locally from a hornblende dominated dolerite to a feldspar dominated granodiorite, is medium to coarse grained, and is complexly interrelated to the mineralised structures in the Lake Cowan area. In a break of form for these generally east-

northeast – west-southwest trending dyke systems, at Lake Cowan the Binneringie dyke follows the deep seated crustal weaknesses north and south for some distance, in the process interfering with the pre-existing mineralisation on a large scale. The majority of mineralisation at the Lake Cowan Mining Centre is hosted within an enclave of Archaean material surrounded by the Binneringie dyke.

7.2.4 Southern Palaeochannels

Throughout the Higginsville Gold Operations, a significant proportion of gold deposits are hosted by sediments within the Southern Palaeochannel network (Figure 7-6). Mineralised zones comprise both placer gold, normally near the base of the channel-fill sequences, and chemically-precipitated secondary gold within the channel-fill materials and underlying saprolite. These gold concentrations commonly overlie, or are adjacent to, primary mineralised zones within Archaean bedrock.

Figure 7-6 Location of the Challenge/Swordsman and Mitchell Palaeochannels

Source: Karora

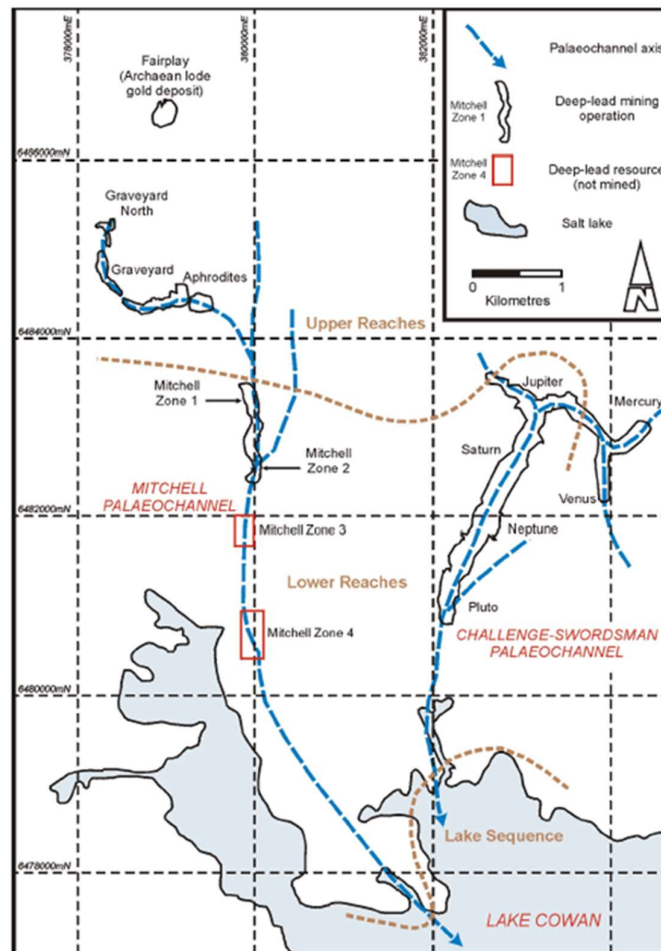

Outcrop is generally poor, due to extensive ferruginisation, calcareous soils, aeolian sands and extensive areas of remnant lacustrine and fluvial sediments. The result is a complex, layered regolith, with considerable chemical re-mobilisation and re-deposition (Lintern et al., 2001).

The regional palaeodrainage system has incised several fault-bounded greenstone sequences, which comprise high-Mg basalt, komatiite and minor interflow sedimentary rocks, intruded by dolerite and gabbro. The orientation of palaeochannels is largely controlled by major faults and shear-zones, that trend north-northwest, parallel to lithological contacts (Swager, 1989; Griffin, 1990).

The Cowan palaeodrainage system that includes the Challenge/Swordsman and Mitchell palaeochannels comprises up to 100 m of Cainozoic sediment overlying Precambrian basement. Clarke (1993) divided the sedimentary sequence into the Eundynie Group, comprising a succession of Eocene sedimentary rocks, and the overlying Redmine Group, comprising Oligocene to Recent deposits.

Two main palaeochannel systems exist at Higginsville:

- Mitchell palaeochannel system includes the existing pits of Graveyard North, Graveyard, Aphrodities and Mitchell. Mitchell 3 and 4 remain unmined and are located to the south of the existing Mitchell pit.
- Challenge/Swordsman palaeochannel system includes the existing pits of Bullseye, Venus, Jupiter, Saturn, Neptune and Pluto. The areas of Mars (south of the Venus Pit) and the southern extension of Pluto remain in situ (unmined).

Both palaeochannel systems get deeper towards the south (which suggest the flow direction of the ancient rivers) and flow into Lake Cowan.

7.2.5 Mt Henry

The Archean rocks in the Norseman area have historically been classified into a series of formations (Figure 7-7 and Figure 7-8), with the following stratigraphic sequence.

7.2.5.1 Penneshaw Formation

The Penneshaw Formation forms the greenstone sequence on the eastern side of the belt. It consists of predominantly mafic volcanic rocks with inter layered units of felsic volcanoclastic and sedimentary rocks, and is intruded by dolerite sills and dykes. Units of the formation host the gold mineralisation at Everlasting and Mildura prospects. The Penneshaw formation is similar to the Woolyeenyer Formation; however, a date of 2,938 (+/-10) Ma derived from a felsic unit has led to the Penneshaw Formation be assigned to an early, separate greenstone unit.

The Penneshaw Formation is intruded by the Buldania Granite Complex in the east and is structurally overlain by the Noganyer Formation in the west.

7.2.5.2 Noganyer Formation

The Noganyer Formation forms a distinct sedimentary sequence of siliclastic rocks, principally silicate facies BIF, chert, sandstones and shales. Intrusions of dolerite dykes and sills are common throughout. An age of 2,706 (+/-5) Ma has been obtained from a chert bed.

The Mt Henry and Selene gold deposits are hosted in the Noganyer Formation.

The Noganyer Formation is conformably overlain by the Woolyeenyer Formation in the west.

Figure 7-7 Geology of the Mt Henry area

Source: Karora

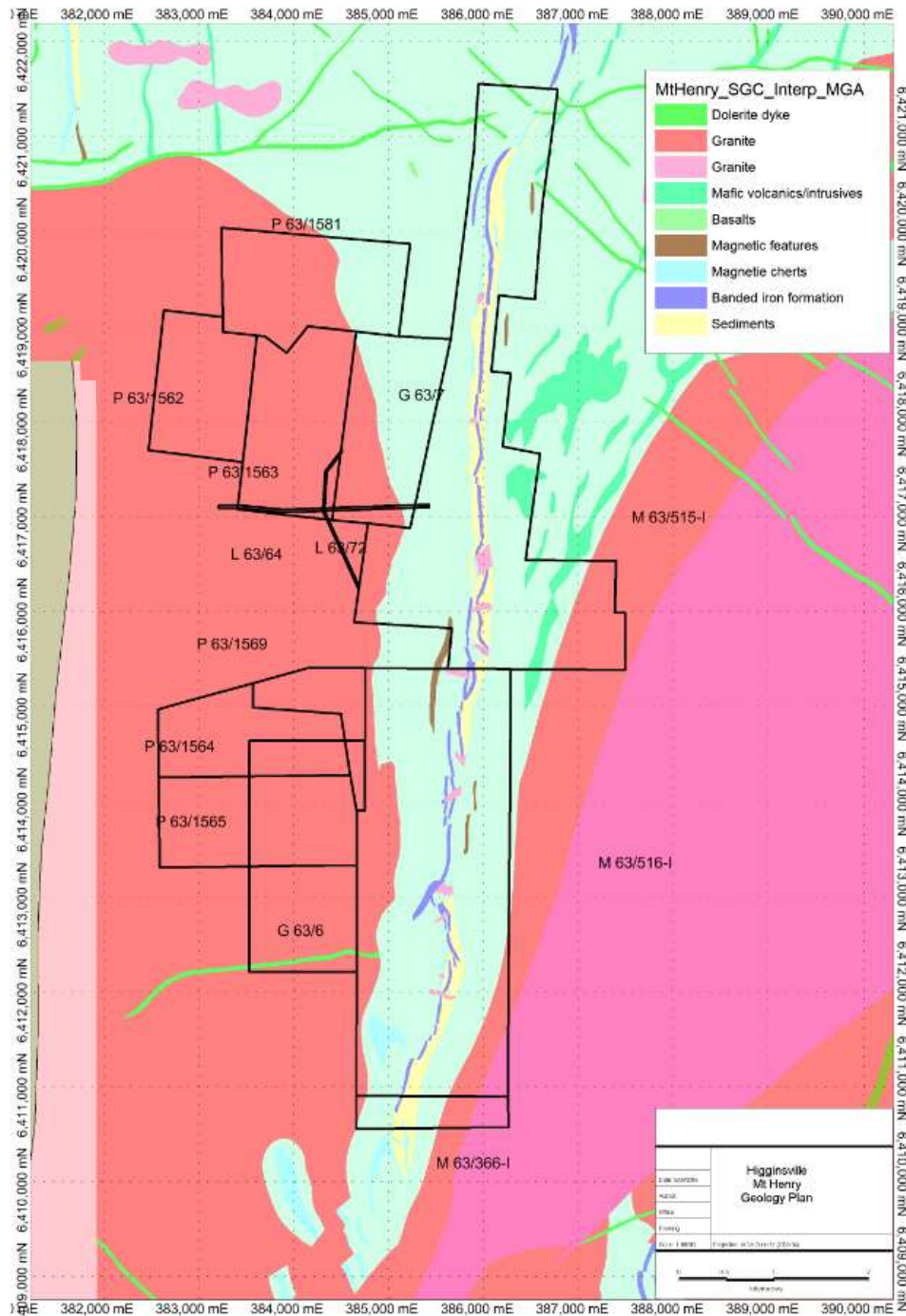
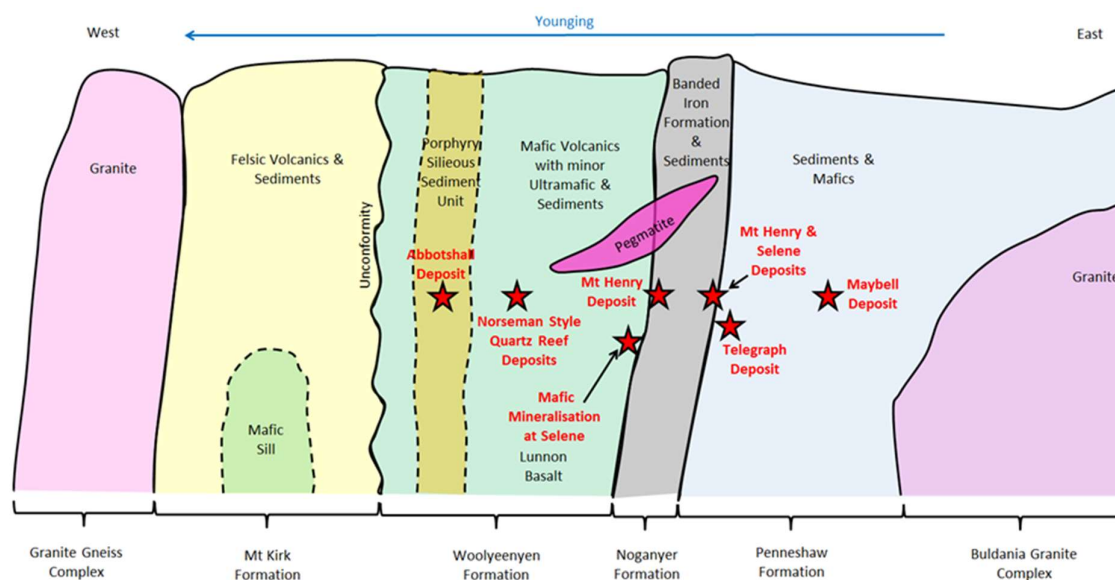

Figure 7-8 Stratigraphic diagram of the Mt Henry area and location of various deposits

Source: Karora



7.2.5.3 Woolyeenyen Formation

The Woolyeenyen Formation both dips and faces west and consists of a sequence of mafic volcanic rocks with minor ultramafic and sedimentary units. Syn-volcanic dolerite dykes and sills intrude the strata and the Noganyer Formation below. One dyke in the lower part of the sequence has an age of 2,714 (+/-5) Ma which is the same age (within error) as the chert in the lower Noganyer Formation.

The Woolyeenyen Formation hosts the Norseman style quartz reef gold mineralisation, as well as the Abbotshall gold deposit which is hosted in a regionally extensive porphyry/siliceous sedimentary unit of the Woolyeenyen Formation.

The Woolyeenyen Formation is unconformably overlain by the Mount Kirk Formation.

7.2.5.4 Mount Kirk Formation

The Mount Kirk Formation consists of felsic volcanic and sedimentary rocks which are intruded by large, thick mafic sills. It has a date of 2,688 (+/-8) Ma.

The Mount Kirk Formation is bounded to the west by a granite-gneiss complex. No gold deposits are known to exist within the Mount Kirk Formation.

7.2.5.5 Intrusive rocks

Intrusive rocks in the Norseman area comprise the following:

- Large external granitoid complexes bound the greenstone belt to the south-east and south-west. These have been dated at 2,686 (+/-6) Ma and 2,691 (+/-8) Ma, respectively.
- A suite of small domal granites and porphyry dykes that intrude the western granitoid complex and the Woolyeenyen Formation. The porphyry dyke at Abbotshall is an example of this type and has been dated at 2,670 Ma to 2,660 Ma.

- Small stocks of potassic granite and associated pegmatite have been dated at 2,612 (+/-12) Ma. The pegmatite dykes that cut the Mt Henry, Selene and North Scotia mineralisation are examples of this intrusive type.
- Proterozoic dolerite dykes the intrude sets of east-west fractures in the craton. The Jimberlana Dyke, dated at 2,411 (+/-38) Ma, is an example of this type.

7.2.6 Polar Bear Group

The geology at Polar Bear is dominated by complexly deformed Achaean greenstone assemblages of the Norseman-Wiluna Greenstone Belt which have been metamorphosed to upper greenschist facies (Figure 7-9). The major regional structures in the area are the Boulder-Lefroy Fault, located approximately 10 km northeast of the project area, the Mission Fault located in the southern portion of the package, and the Black Knob Fault that transects the central portion of the project. The Mission Fault merges with the Black Knob Fault in the southwest portion of the project area. Both the Boulder-Lefroy and the Black Knob faults strike north-northwest. The Black Knob Fault is interpreted to be the southern extension of the Zuleika Shear.

Lake Cowan covers most of the project area with a 1 m to 3 m thick layer of gypferrous mud and clay with a poorly developed halite crust. The deeper channels within the lake contain thick sequences of transported clays, with intercalated lignite beds from 1 m to 20 m, which overlie laterally extensive fossiliferous sandstone, locally known as the Norseman Formation of probable Eocene age. Locally running sands and gravels are present at the base of the channels, which can be in excess of 90 m thick. Some of these channels are mineralised with gold and have been mined historically, including the Challenge-Swordsman palaeochannel on the Eundynie Peninsula. The entire project area is intruded by numerous Proterozoic dolerite dykes.

The local Polar Bear geology is characterised by a complex array of structural features including repeated thrusts, folding, plunging and shearing. Meta-basalt, meta-dolerite and repeated flows of serpentinised peridotites and pyroxenites are the dominant lithologies. Wedged within the greenstone sequences are steeply dipping black shale and chert units. Carbonate-talc alteration of ultramafic units is common and often accompanied by asbestos veining. Felsic intrusions in the form of massive quartz-feldspar-biotite porphyritic granites are widespread in the northern islands and northern Peninsula. At the Snout gold prospect, the coarse felsic unit is repeatedly cross-cut by quartz veinlets often containing visible sulphides.

Figure 7-9 Geology of the Polar Bear region

Source: Karora

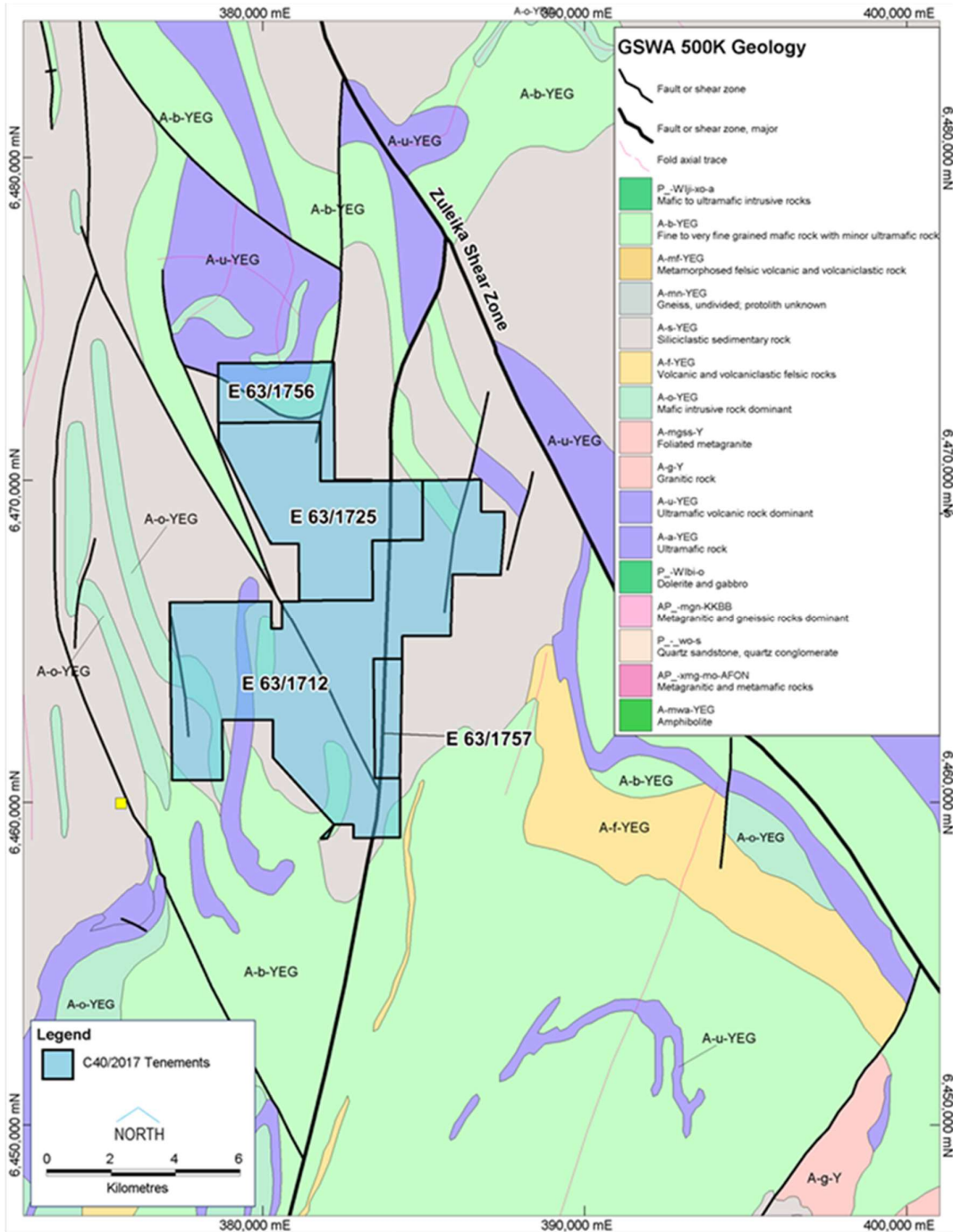

7.2.7 Spargos Project Area

The Spargos Project occurs within Coolgardie Domain of the Kalgoorlie Terrane. The western boundary of the domain is marked by the Ida Fault, a crustal-scale suture that separates the eastern goldfields from older terranes to the west. Its eastern margin is marked by the Zuleika Fault. The geological setting comprises tightly-folded north-south striking ultramafic and mafic volcanic rocks at the northern closure Widgiemooltha Dome.

The volcanic sequence contains interbedded black shale horizons and is overlain by felsic volcanoclastic rocks, arenites and siltstones. The entire sequence has been intruded by granite and pegmatites, and cut by Proterozoic dolerite dykes. The area bounded by the Zuleika Shear to the east and the Kunanulling Shear to the west is characterised by middle to upper amphibolite facies metamorphism.

Structurally, the area is complex with early thrust faulting and recumbent folding followed by tight isoclinal folding and strike slip faulting resulting in multiple repetitions of individual units. Locally, the anticlinal positions are occupied by granite bodies with the Archean stratigraphy wrapping around the domal structures. The project lies on the general trend of the Kunanulling/Karramindie Shear corridor, a regional shear zone that hosts significant mineralisation to the north at Ghost Crab (Mount Marion), Wattle Dam to the south, the Penfolds group and Kunanulling. The regional prospective Zuleika Shear lies to the east of the project.

The tenements are prospective for vein and shear hosted gold deposits as demonstrated by Spargos Reward and numerous other gold workings and occurrences. The high-grade shear hosted gold mineralisation at Wattle Dam occurs just 15 km to the south and along strike of the Spargos Reward deposit and highlights the potential for additional significant high-grade shoots along this trend (Figure 7-10).

Gold mineralisation at Spargos Reward is hosted by a coarse-grained pyrite-arsenopyrite lode in quartz-sericite schists, between strongly biotitic altered greywacke to the east and quartz-sericite-fuchsite-pyrite altered felsic tuff to the west. Gold mineralisation is associated with very little quartz veining which is atypical for many deposits in region. Sporadic lower-grade gold mineralisation (1–2 g/t Au) occurs within the footwall tuffs.

The Spargos Reward setting has been described variously as a low-quartz sulphidic mesothermal gold system or as a Hemlo style syn-sedimentary occurrence.

Figure 7-10 Regional Geology highlighting major structures and gold deposits

Source: Modified after Corona Resources, 2020

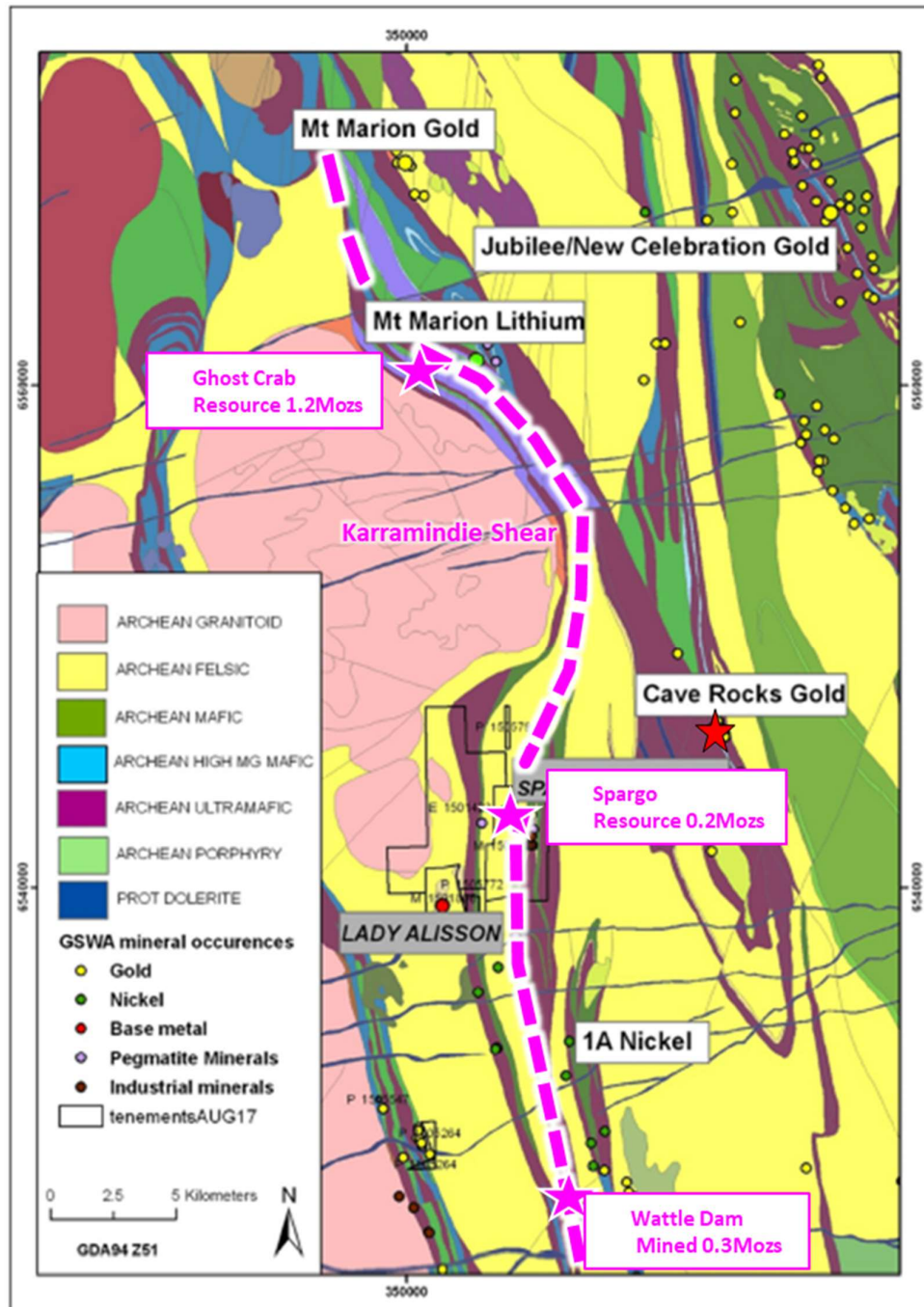

8 DEPOSIT TYPES

The gold deposits at Higginsville are consistent with the greenstone-hosted quartz-carbonate vein (mesothermal) gold deposit model. Exploration for extensions of these deposits and new deposits are therefore based on these models as described below.

8.1 GREENSTONE-HOSTED QUARTZ-CARBONATE VEIN GOLD DEPOSITS

Greenstone-hosted quartz-carbonate vein deposits (GQC) are a sub-type of lode gold deposits (Poulsen et al., 2000) (Figure 8-1). They are also known as mesothermal, orogenic, lode gold, shear-zone-related quartz-carbonate or gold-only deposits (Dubé and Gosselin, 2007).

Figure 8-1 Inferred crustal levels of gold deposition showing the different types of gold deposits and the inferred deposit clan

Source: Dubé and Gosselin (2007) modified after Poulsen et al. (2000)

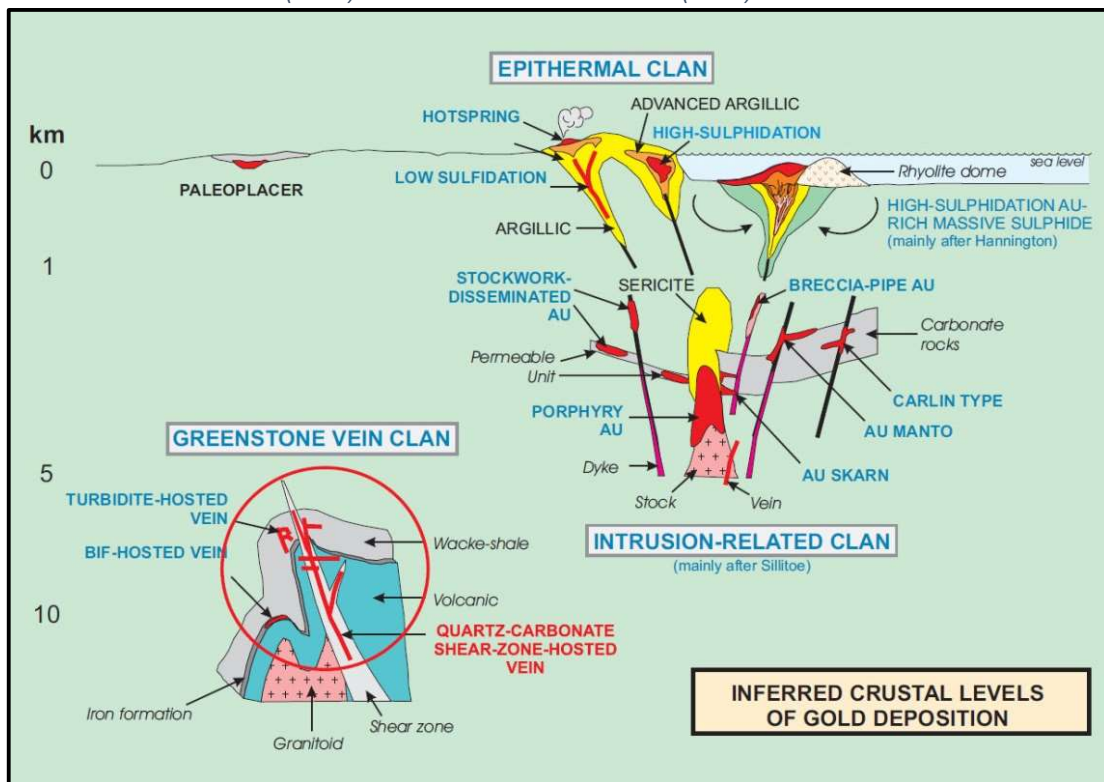

The deposits correspond to structurally controlled complex epigenetic deposits hosted in deformed metamorphosed terranes. They consist of simple to complex networks of gold bearing, laminated quartz-carbonate fault-fill veins in moderately to steeply dipping, compressional brittle-ductile shear zones and faults with locally associated shallow-dipping extensional veins and hydrothermal breccias. They are hosted by greenschist to locally amphibolite facies metamorphic rocks of dominantly mafic composition and formed at intermediate depth in the crust (5–10 km).

They are typically associated with iron-carbonate alteration. The mineralization is syn- to late-deformation and typically post-peak greenschist facies or syn-peak amphibolite facies metamorphism. They are genetically associated with a low salinity, CO₂-H₂O-rich hydrothermal

fluid thought to also contain methane, nitrogen, potassium and sulphur. Gold is largely confined to the quartz-carbonate vein network, but may also be present in significant amounts within iron-rich sulphidized wallrock selvages or silicified and arsenopyrite-rich replacement zones. They are distributed along major compressional to transtensional crustal-scale fault zones in deformed greenstone terranes of all ages, but are more abundant and significant, in terms of total gold content, in Archean terranes.

However, a significant number of world-class deposits are also found in Proterozoic and Paleozoic terranes. International examples of this sub-type of gold-deposits include Mother Lode-Grass Valley (U.S.A.), Mount Charlotte, Norseman and Victory (Australia), and Dome, Kerr Addison and Giant (Canada).

8.1.1 Diagnostic Features

The diagnostic features of the greenstone-hosted quartz-carbonate vein type gold deposits are arrays and networks of fault- and shear-zone-related quartz-carbonate laminated fault-fill and extensional veins in associated carbonatized metamorphosed greenstone rocks. The deposits are typically associated with large scale (crustal) compressional faults. They have a very significant vertical extent (≤ 2 km), with a very limited metallic zonation.

8.1.2 Grade and Tonnage Characteristics

The greenstone-hosted quartz-carbonate vein deposits are one of the most significant sources of gold and account for 13.1% of all the world gold content (production and reserves). They are second only to the Witwatersrand paleoplacers of South Africa. The largest GQC deposit in terms of total gold content is the Golden Mile complex in Kalgoorlie, Australia with 1,821 t Au. The Hollinger-McIntyre deposit in Timmins, Ontario, is the second largest deposit ever found with 987 t Au. The average grade of the deposits varies from 5 g/t Au to 15 g/t Au, whereas the tonnage is highly variable from a few thousand to tens of millions tonnes of ore, although more typically there are only a few million tonnes of ore.

8.2 SEDIMENT-HOSTED PALAEOCHANNEL DEPOSITS

From Westgold (2017b):

“Throughout the Higginsville Gold Operations, a significant proportion of gold deposits are hosted by sediments within Southern Palaeochannel networks. Mineralised zones comprise both placer gold, normally near the base of the channel-fill sequences, and chemically-precipitated secondary gold within the channel-fill materials and underlying saprolite (Figure 8-2). These gold concentrations commonly overlie, or are adjacent to, primary mineralised zones within Archaean bedrock. Outcrop is generally poor, due to extensive ferruginisation, calcareous soils, aeolian sands and extensive areas of remnant lacustrine and fluvial sediments. The result is a complex, layered regolith, with considerable chemical re-mobilisation and re-deposition (Lintern et. al., 2001).

The regional palaeodrainage system has incised several fault-bounded greenstone sequences, which comprise high-Mg basalt, komatiite and minor interflow sedimentary rocks, intruded by dolerite and gabbro. The orientation of palaeochannels is largely controlled by major faults and shear-zones, that trend north-northwest, parallel to lithological contacts (Swager, 1989; Griffin, 1990).

The Cowan palaeodrainage system that includes the Challenge/Swordsman and Mitchell palaeochannels, comprises up to 100 m of Cainozoic sediment overlying Precambrian

basement. Clarke (1993) divided the sedimentary sequence into the Eundynie Group, comprising a succession of Eocene sedimentary rocks, and the overlying Redmine Group, comprising Oligocene to Recent deposits (Figure 8-2).

Figure 8-2 Schematic geology of the Southern Paleochannel area showing the mineralisation position

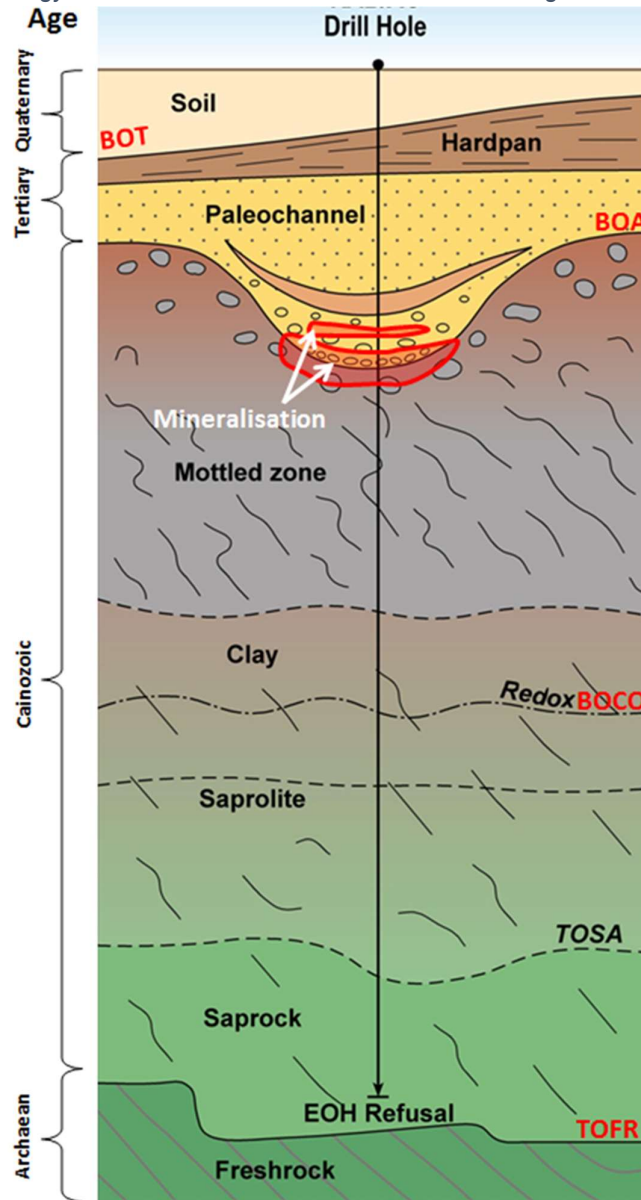

Within oxidised basal sediments gold distribution is typically irregular and sparse. Placer gold is confined to quartzitic sand and gravel lag adjacent to a Tertiary/Archaean unconformity (autochthonous style), and is absent from clay and sand units throughout the upper part of the basal sand facies (allochthonous style). Placer gold may be preferentially concentrated according to palaeotopography where highly-elevated concentrations, commonly incorporating nugget-sized gold grains, occur at stream junctions, particularly in the upper reaches of channel systems. Elevated concentrations may also occur with particular orientations of the channel base, defined by regional bedrock structures.”

9 EXPLORATION

9.1 SUMMARY

Non-drilling exploration activities for gold mineralization on the HGO tenements included desktop geochemistry studies, detailed gravity surveys, and soil and rock-chip sampling surveys. This work is detailed below.

9.2 GEOPHYSICAL SURVEYS

Atlas Geophysics (Australian global gravity survey contractors) completed the acquisition and processing of 3,960 new gravity stations for Karora Resources over three areas: Abbotshall, Higgsville and Lefroy, approximately 10 km south-west, 50 km north and 90 km north, respectively, of Norseman in Western Australia (Figure 9-1).

Gravity stations in all three areas were acquired using a 200 m x 100 m grid configuration. Atlas Geophysics completed the acquisition of the dataset with two crews utilising foot-borne gravity methods.

The following instrumentation was used for acquisition of the gravity data:

- Three CG-5 Autograv Gravity Meters
 - (Serial Number: 40298, SF: 0.999394)
 - (Serial Number: 41478, SF: 1.000000)
 - (Serial Number: 40382, SF: 1.000000)
- Two CHC i70+ GNSS Rover Receivers
- Two CHC i70+ GNSS Base Receivers.

The gravity survey was completed in 28 days of acquisition. An average acquisition rate of around 141 stations per day of production was achieved for the survey.

Final data met project specifications. Repeatability of the data was excellent, with the standard deviation of the elevation repeats at 0.022 m and the standard deviation of the gravity repeats at 0.025 mgal.

The results of the gravity surveys produced excellent imagery highlighting the various high- and low-density features amongst the underlying geology (Figure 9-2 to Figure 9-4).

Figure 9-1 Locations of geophysical surveys by Atlas Geophysics 2020

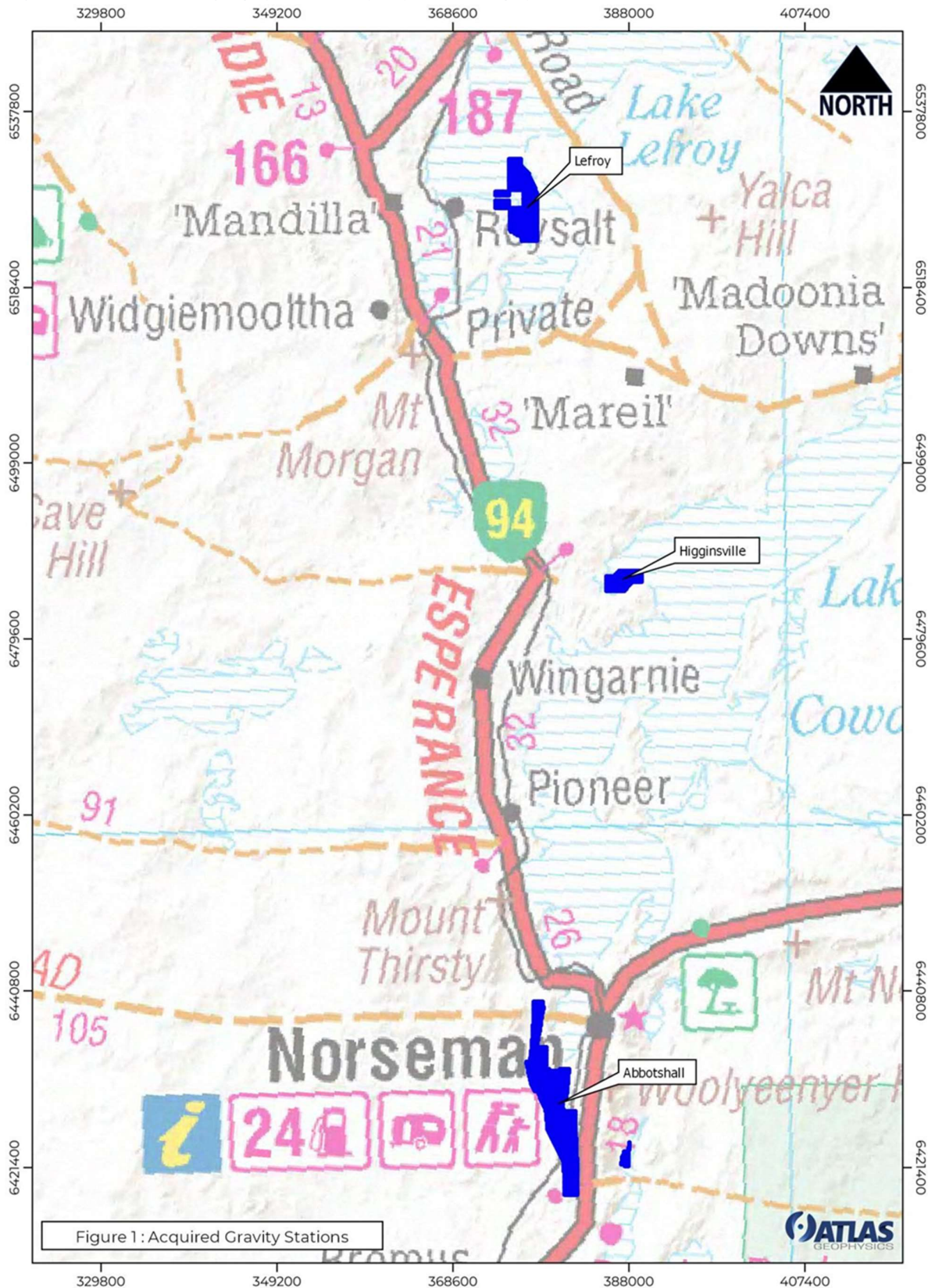

Figure 9-2 Processed Abbotshall gravity survey

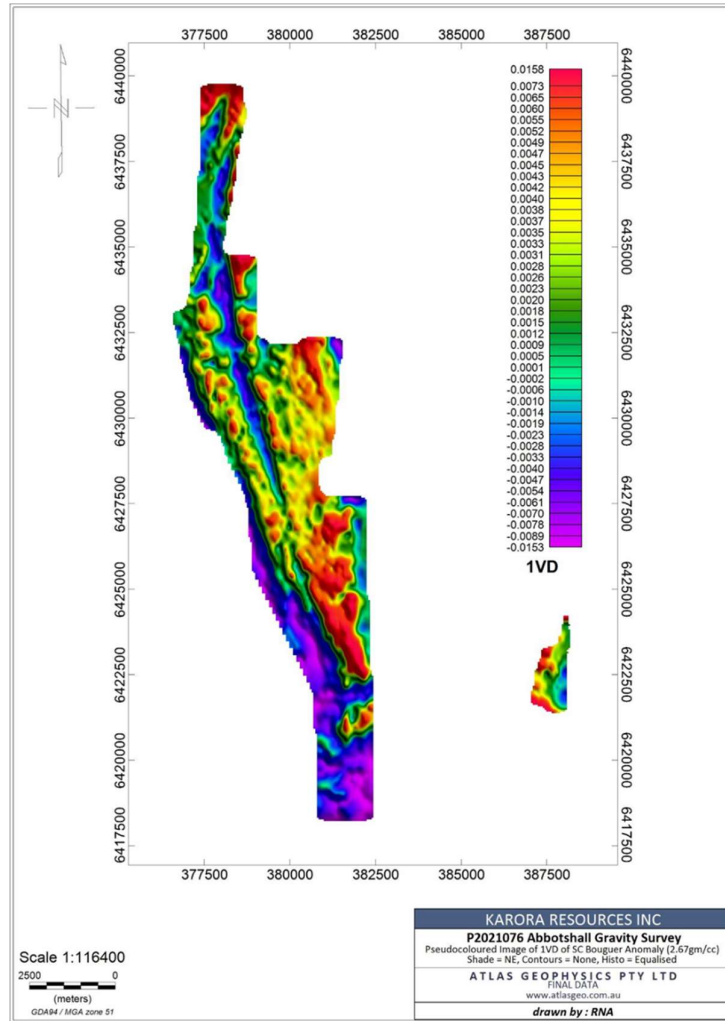

Figure 9-3 Processed Higginsville gravity survey

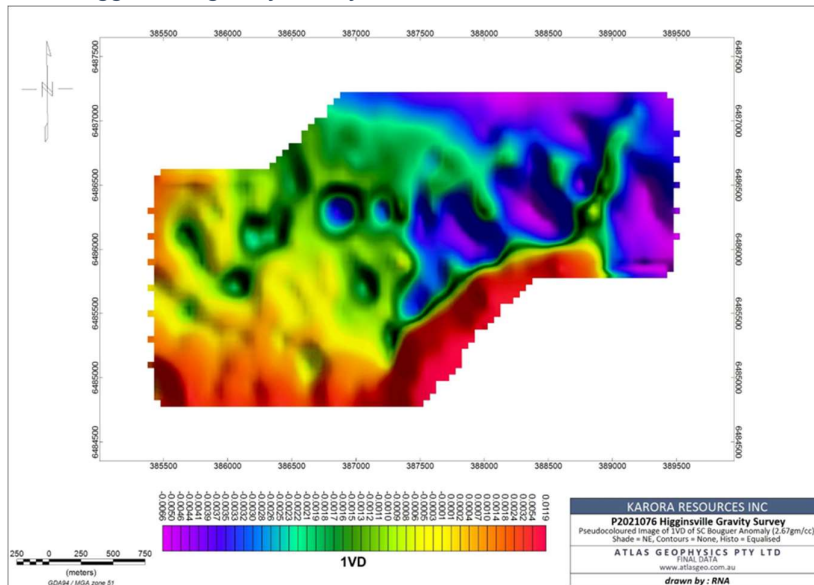
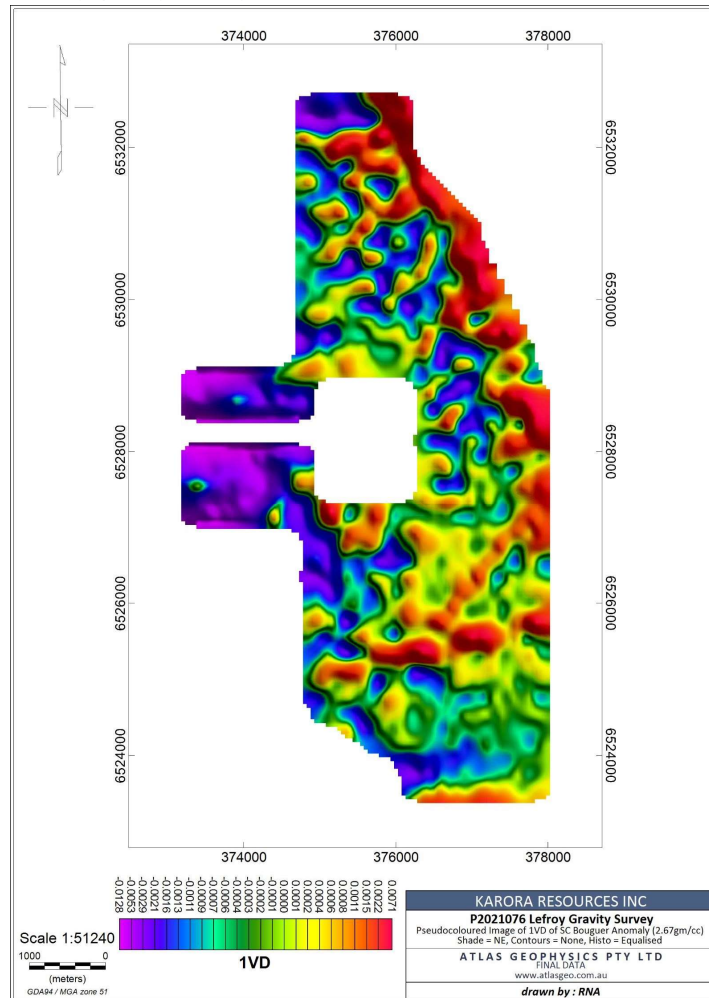

Figure 9-4 Processed Lefroy gravity survey



9.3 SOIL AND ROCK CHIP SAMPLING

A total of 5,052 surface samples were collected during the reporting period over a range of Karora tenements (Figure 9-5). This comprised 2,938 soil samples and 2,114 rock chip samples (grab and outcrop). Samples were collected on a variety of grid spacings depending on the program requirements, the tenement size/shape and any historic data that was present.

Samples were sent for gold and multi element analysis to Bureau Veritas or ALS (Table 9-1).

Table 9-1 Description of assay methods used and number of related samples

Sample Method	Number of Samples	Laboratory	Description
AR_ICPMS	9	Bureau Veritas, Perth	Aqua regia Au + 44 multi-element suit
AR_ICPMS	1438	Bureau Veritas, Perth	Aqua regia (Au)
AR_ICPXS	3377	ALS, Perth	25g aqua regia digest for Au + 50 multi-elements
AROR_ICPXS	5	ALS, Perth	Aqua regia digest over range for Au + 50 multi-elements
FA_AAS	181	Bureau Veritas, Kalgoorlie	Lead collection fire assay (Au)

Figure 9-5 Locations of all surface samples collected on Karora tenements

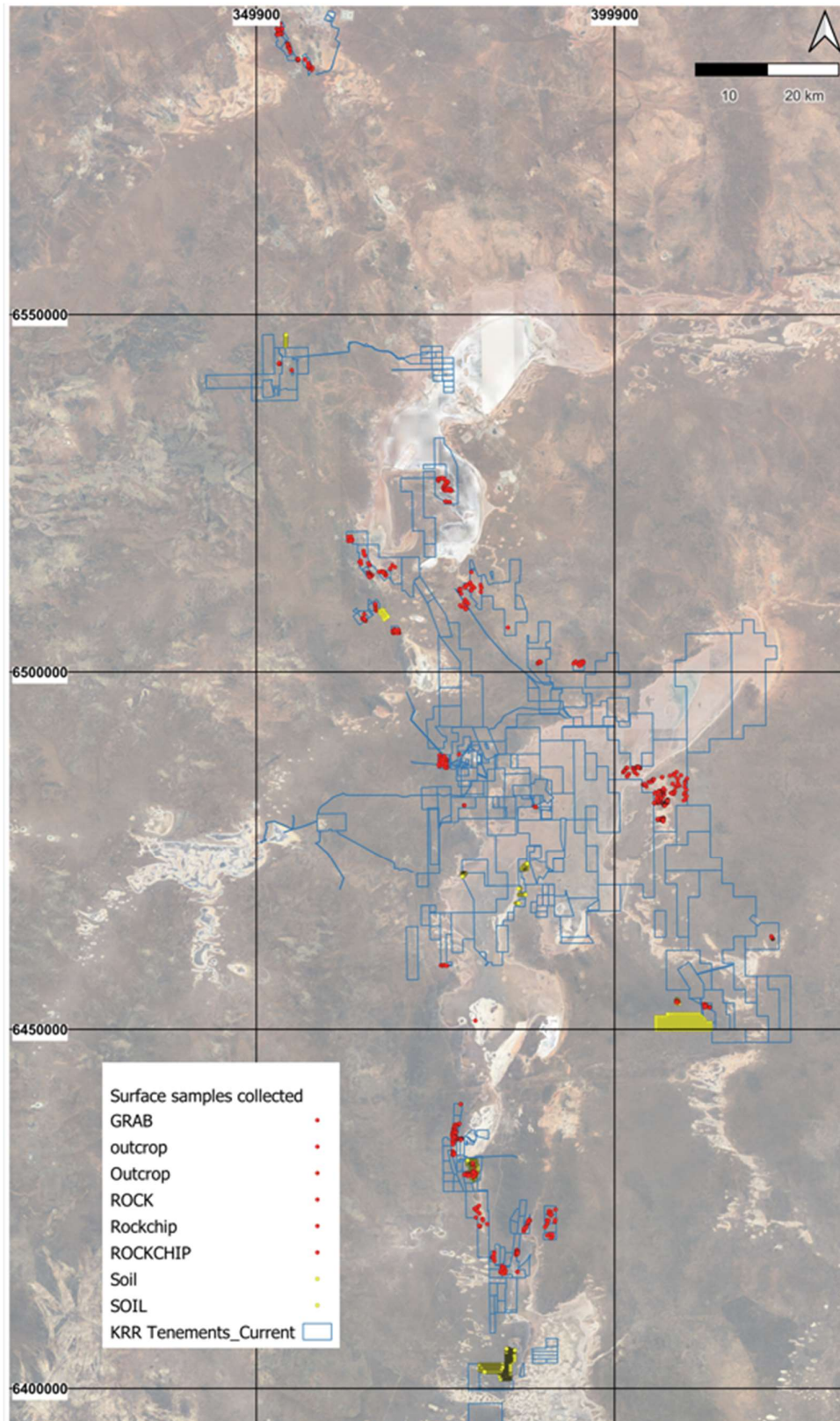

9.4 3D STRUCTURAL MODELLING (MODEL EARTH)

Karora requested that Model Earth (consultancy group) assist in the understanding and modelling of the Spargos Reward deposit and the Trident Line-of-Lode deposits/prospects adjacent to the Higginsville Mill, as well as assessing the potential for further gold deposits. The scope of work involved the collection and integration of multiple data sets to create 3D Models and exploration targets generated from that model. Data used and collected were assays, pXRF results, diamond core relogging, pit mapping, 3D lithochem, core logging and geochemistry and 3D structural frameworks.

9.4.1 Spargos Reward

Model Earth used geochemical analysis via pXRF to collect the data and ioGAS software to process the data. Using this process, a lithochem 3D model was completed in Leapfrog as well as a 3D structural model (Model Earth, 2021b). Following this, an analysis of the controls on mineralisation and future targeting of the Spargos Reward ore lodes was completed.

The primary control on the plunge of orebodies at Spargos Reward is moderate (40°–55°) NNE-plunging folding and the intersection of associated S1 (pervasive) foliation with bedding or lithology boundaries. These primary high-grade plunges are compartmentalised by the intersection of steeply dipping shear zones at around 10° oblique to the orebody. Intersections generally plunge steep (60°–80°) towards the SSW, but are locally more complicated due to the small angle between the shear zones and lithology boundary. Locally, steep SSW plunging high-grade zones may be related to boudins or steps in these shear zones. A visual summary of the primary controls is shown in Figure 9-6.

Figure 9-6 Model Earth's primary control on the plunge of orebodies at Spargos Reward is moderate (40°–55°) NNE-plunging folding and the intersection of associated S1 (pervasive) foliation with bedding or lithology boundaries

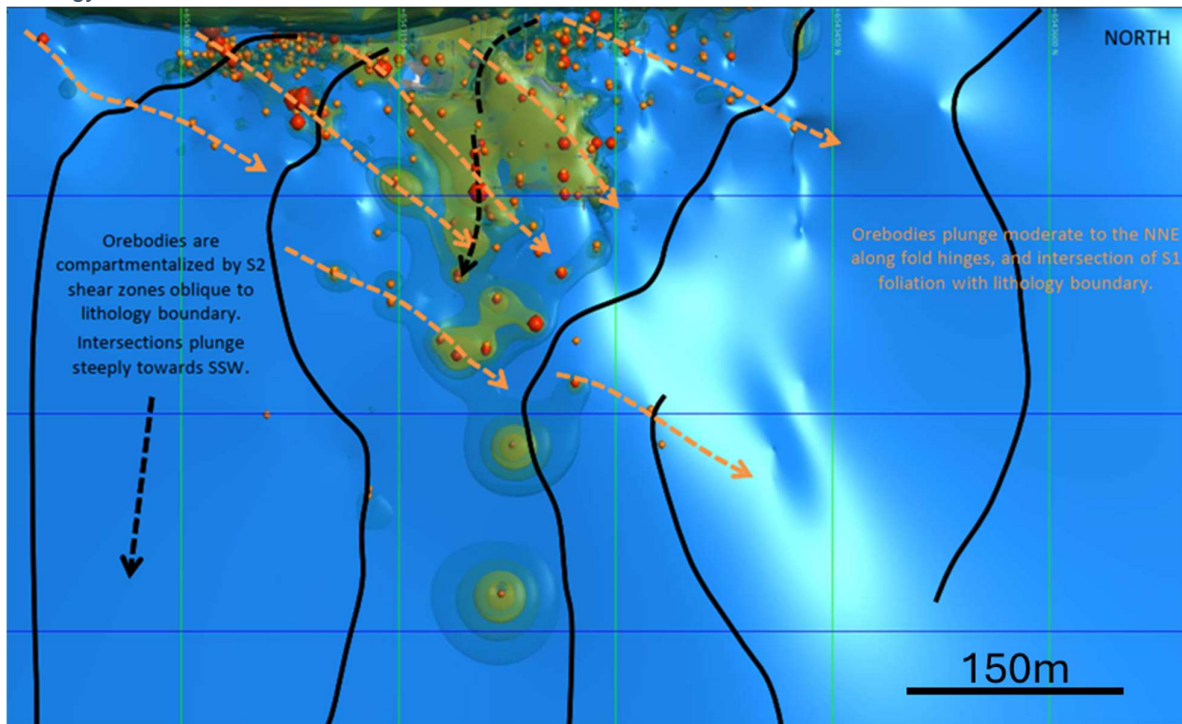

The most apparent exploration opportunity to come from 3D modelling is noting the lack of drilling where the main shear zone corridor intersects the felsic volcanic-mafic sediment boundary, below and to the immediate SSW of the Spargos Reward deposit. Exploration up to this point in time of modelling has been focused on the NNE plunging continuity of Au-grade.

9.4.2 Trident Line-of-Lode

Model Earth provided a solid geological model and insight into the important features of prospectivity for the area (Model Earth, 2021a). The Trident Line-of-Lode (LOL) trend is deformed by a series of anastomosing shear zones comprising NNW and NNE trending segments. The structures are predominantly east-dipping with reverse kinematics and vary in dip from subvertical to around 30°. Overall strain along the LOL is quite low, but offset along some shear zones of a few hundred metres is apparent from changes in lithology. Despite local modification by shearing/thrusting, the primary stratigraphy of the Trident LOL is relatively intact. Younging-east indicators in sediments and the differentiation of sills indicate most of the stratigraphy is right way up along the length of the LOL. The asymmetric geometry of sills and ultramafic flows, and the unexplained termination of these units to the NW, suggest an early basin fault architecture that has caused changes in the thickness of deposited (and/or intruded) units prior to shearing and gold mineralisation.

The thickened end of the Trident Sill at Trident-Poseidon is unique in the LOL, and it would make sense to prioritise exploration efforts around this feature (Figure 9-7). In the remainder of the LOL, the known sills are thinner and more discontinuous, with less chance of differentiation creating favorable host rocks for larger gold deposits. The Vine deposit has the most potential for expansion as it occurs in a reasonably thick and differentiated part of the Vine Sill, but is still roughly 10 times less volume than the sill at Trident-Poseidon, and the deposit has been drilled down dip with little indication that the sill expands. The potential is relatively good for finding extensions to known orebodies or for finding smaller new orebodies (hosted by dolerite/gabbro or in other host rocks) along the LOL away from Trident-Poseidon. These deposits will be hard to predict, small compared to Trident-Poseidon, and difficult to justify exploration costs to any significant depth. The potential of the Northwest Unknown area remains unknown. Structural conduits for gold-bearing hydrothermal fluid are almost certainly present. The exploration potential of this area hinges on discovery of suitable host rocks to be deformed and fractured by these structures to form a significant deposit.

Figure 9-7 Model Earth overview geology for Line-of-Lode with focus on the fractionation of mafics being significant

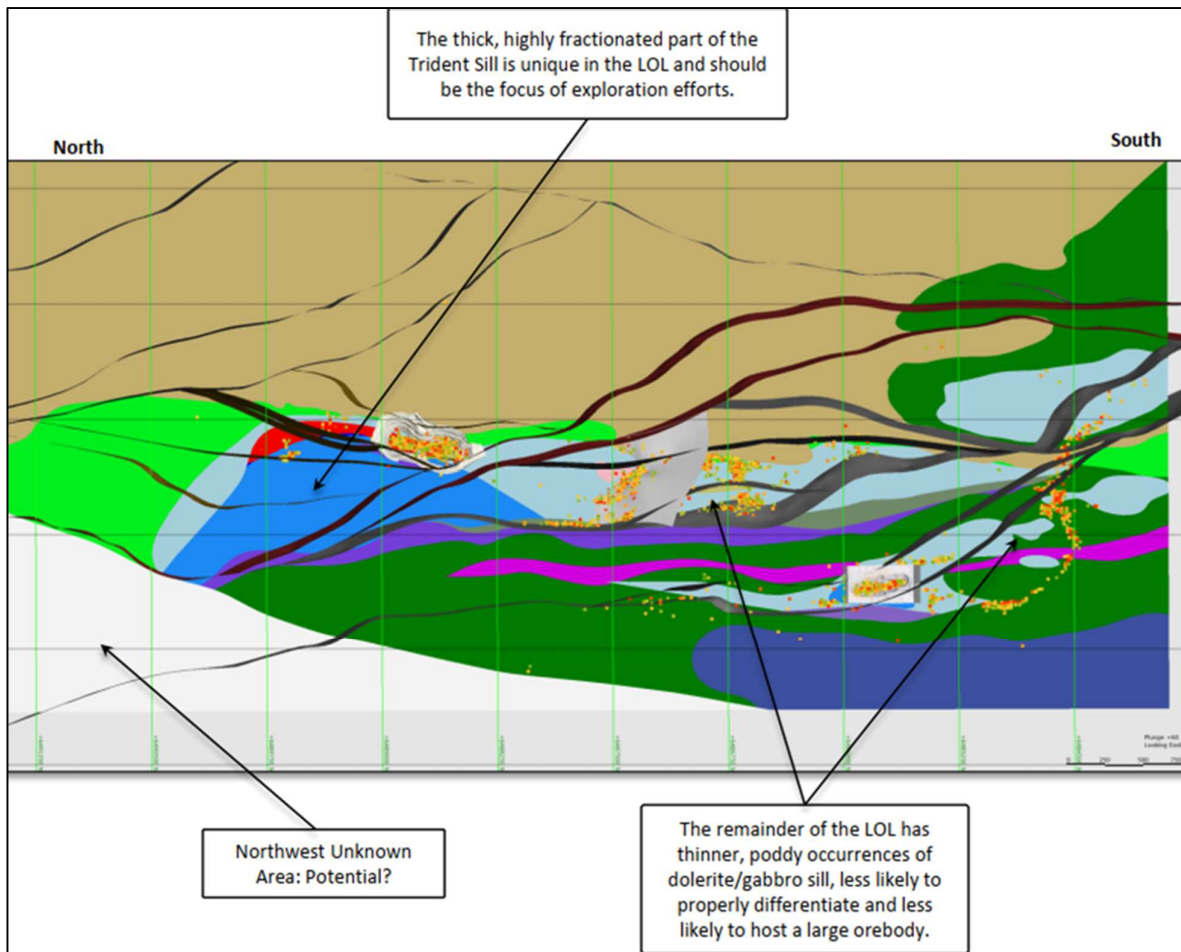

9.5 INTEGRATED 3D REGIONAL GEOLOGICAL MODEL TRIDENT NORTH (CSA GLOBAL)

Karora requested that CSA Global (geological consultants) assist in understanding the HGO district geology and target generation in the Trident North area. An integrated 3D regional geological model (Figure 9-8) was developed for the Trident North district in Leapfrog (CSA Global, 2022). The modelling integrates various datasets including lithology logging, lithogeochemical analysis and geophysical layers (primarily magnetics). At Trident, the key structures correlated with gold mineralisation are identified as a moderately E-dipping shear foliation, interpreted to be related to east-west shortening and activity on the Poseidon Thrust, and veining, which is either sub-parallel to the shear foliation, or is north-south striking and steeply east and west dipping. The sub-vertical structures are correlated with higher Au values overall, although the moderately east-dipping fabric can also be associated with anomalous gold and high-grade outliers. At Barcelona, foliation and veins are dominantly sub-vertical or steeply dip to the WSW or ENE and strike NNW-SSE. Veins in this orientation correlate most consistently with elevated Au grades. A minor shallow west-dipping vein population is not consistently correlated with elevated Au grades, but does correlate with the highest Au outliers up to 4 g/t Au.

Figure 9-8 Example of lithochemostrgy evaluation in general showing a good correlation between logged/modelled lithology and geochemistry

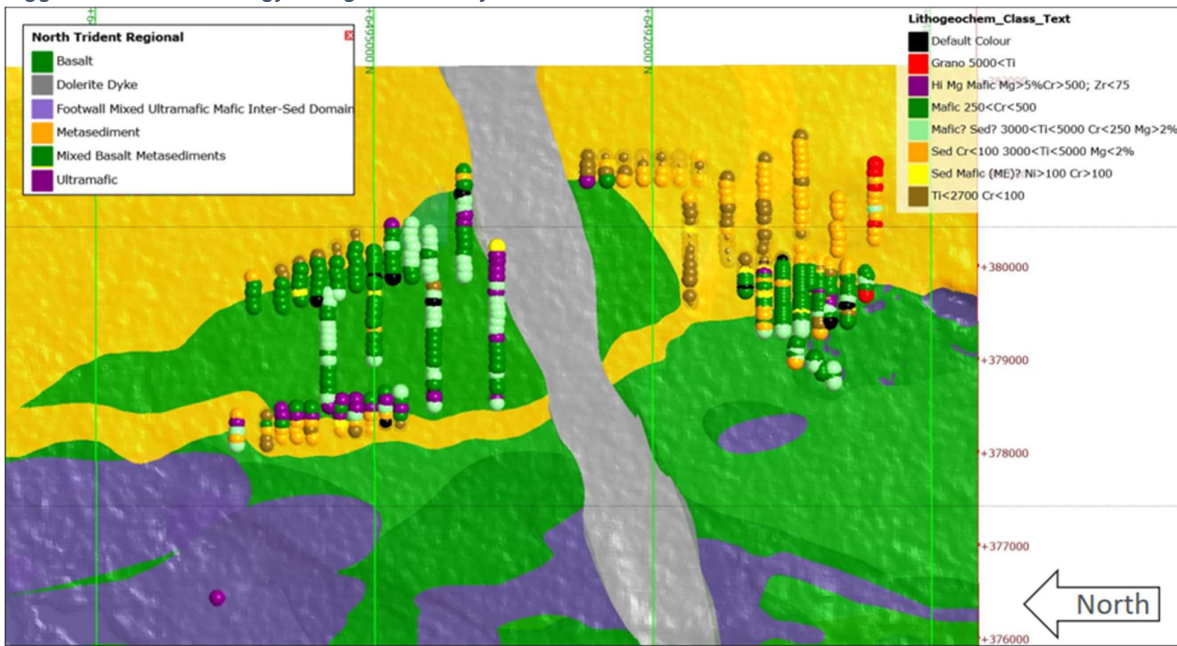

10 DRILLING

10.1 DRILLING SUMMARY

Since the last Technical Report, Karora drilled 2,084 Exploration and Resource Development holes for 157,544 m (October 1, 2020 to July 2, 2023). Drilling was completed for the purpose of development of gold resources as well as exploration for new gold deposits. The total drill holes and metres by type are shown in Table 10-1 with total drill holes and metres by prospect shown in Table 10-2.

Table 10-1 Higginsville drill hole database– number of holes and metres drilled between October 1, 2020 and July 2, 2023

Drill Type	Number of Holes	Metres
AC	1,094	47,427
DDH	77	18,879
RC	775	60,062
RC/DDH	138	31,176
Grand Total	2,084	157,544

Table 10-2 Drilling by prospect and hole type from October 1, 2020 to July 2, 2023

Prospect	Hole_Type	Number of Holes	Metres
Ajax North	RC	8	604
Ajax South	RC	10	413
Aquarius_HGO	DDH	20	2,001
	RC	8	724
	RC/DDH	37	11,908
Baloo	RC	8	932
	RC/DDH	3	336
Bandido	RC	12	924
Barcelona	DDH	1	295
	RC/DDH	4	822
Dundas	RC	34	3,109
Eivers	RC	15	1,590
Eyre Bend	RC	6	617
Fairplay	DDH	1	229
	RC	7	1,118
	RC/DDH	2	785
Flynns Island	RC	11	312
Gravel Pit	RC	5	180
Hidden Secret	RC	27	2,840
Igloo	RC	6	920
Jeffreys South	RC	7	414
Josephine	RC	1	90
	RC/DDH	5	1,623

Prospect	Hole_Type	Number of Holes	Metres
Lake Cowan	AC	802	36,344
	DDH	3	610
	RC	4	624
Magip	RC	35	1,860
Mouse Hollow	RC	12	1,662
	RC/DDH	13	2,254
No Secret	RC	46	2,293
Norcott	AC	236	8,551
Pioneer One	DDH	9	700
	RC	89	6,417
Porphyry	RC	11	1,112
Porphyry 6	RC	58	3,000
Poseidon South	RC	5	1,014
Rainer	RC	106	5,621
Regional	RC	6	144
Republican	RC	6	547
Sinclair Soak	DDH	2	445
Spargos Reward	DDH	23	9,564
	RC	118	10,143
	RC/DDH	3	1,240
Spargos South	DDH	2	745
	RC	12	2,568
Spargos Sterilisation	RC	24	2,880
Spongelite	RC	16	720
Swagman	RC	8	680
	RC/DDH	23	2,658
Syenite	AC	56	2,532
Trident	DDH	2	788
	RC	6	1,273
	RC/DDH	3	1,118
Two Boys	DDH	14	3,504
	RC	4	489
	RC/DDH	45	8,434
White Dam	RC	21	911
Wishbone	RC	4	93
Zebra Hill	RC	19	1,224
Grand Total		2,084	157,544

10.2 DRILLING MAPS

Figure 10-1 shows the drilling distribution for HGO.

Figure 10-1 Distribution of drilling between October 1, 2020 and July 2, 2023 within the Higginsville tenement

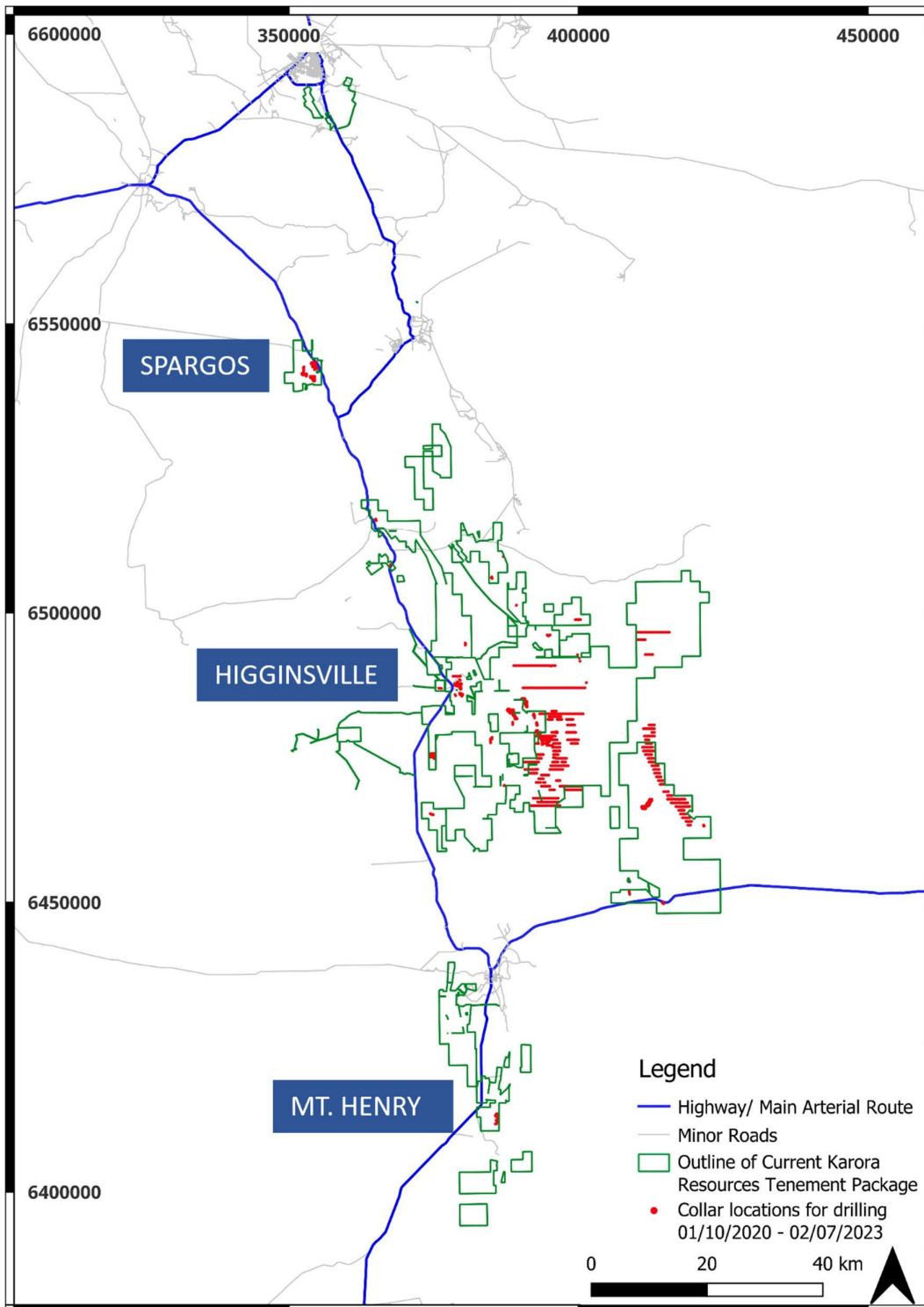

Drill hole collars are originally set out by surveyors once the coordinates have been given by the geologists. They are later picked up once they are drilled. The surveyor uploads the coordinates given to them onto the Trimble GPS controller which also includes the hole IDs. This is then used to stake out the holes again and ensure the correct ID is used when picking up the hole and that it matches the hole ID on the stake. The holes are picked up in MGA94 (Zone 51) coordinates using RTK. Once picked up, the survey team exports this to a CSV file which includes the hole ID, method of survey (RTK), MGA94 eastings, MGA94 northings, MGA RL, surveyors name, coordinate system and survey instrument (R12).

Downhole surveys are undertaken on each hole by drilling contractors using digital true north seeking gyro instruments. During first pass exploration RC and AC drill holes, single shot downhole survey measurements are taken at 4 m depth then at 30 m depth, followed by 30 m intervals before the final reading taken at end of hole. During resource development RC drilling programs, single shot surveys are taken every 30 m downhole to monitor hole deviation during active drilling. Results are actively monitored by the supervising geologist as the hole progresses. This is then followed up by a multi-shot survey at every 5 m or 10 m interval throughout the length of the hole on completion of each hole. For all DD holes, multi-shot surveys are conducted as described above, with hole deviation being monitored by single shot surveys at 50 m intervals downhole as drilling progresses.

10.3 RESULTS

Interpretation of results from three key projects: Spargos, Sleuth Trend and Norcott, drilled between October 1, 2020 and July 2, 2023 are detailed below and are supported by representative drill assays and interpretation.

10.3.1 Lake Cowan and Sleuth Trend

The identified Sleuth Trend area is a southeast striking, approximately 20 km zone of identified gold anomalism beginning at the already mined Baloo pit, 15 km east of the Higginsville Mill (Figure 10-2). The trend mainly resides beneath the western margin of Lake Cowan.

The 5-km segment between Baloo and Monsoon was aircore drill tested in parts returning low-level gold assays supportive of a mineralized trend, while initial RC and diamond drilling has indicated high grade mineralization present at depth. A total of 17,829 m over 414 aircore holes was drilled over the Lake Cowan Project area in 2021, including the targeted Sleuth Trend. In addition to the aircore drilling, in 2021 Karora designed and drilled an initial drill program of four lake-RC and three lake-diamond holes totalling 1,355 m to test below a strong regolith anomaly located 1 km northwest of the main Monsoon prospect (and along the Sleuth Trend).

Highlights from the drilling are listed in Table 10-3 and shown on Figure 10-3.

Table 10-3 Drilling highlights from Lake Cowan, 2021

Hole	Result
Lake Cowan AC significant levels (>0.2 g/t Au)	
HIGA8864	1.35 g/t Au over 50 m from 68 m including 16m at 3.64 g/t Au from 72 m
HIGA9653	0.36 g/t Au over 36 m from 52 m including 4 m at 3.1 g/t Au from 56 m.
HIGA9672	0.42 g/t Au over 19 m from 60 m including 2 m at 3.0 g/t Au from 76 m.
HIGA9636	0.24 g/t Au over 16 m from 68 m including 1 m at 1.39 g/t Au from 80 m.
HIGA9631	0.36 g/t Au over 12 m from 68 m.
HIGA9609	0.22 g/t Au over 18 m from 68 m.

Hole	Result
HIGA9623	0.21 g/t Au over 4 m from 48 m.
Lake Cowan RC and DD significant intercepts (> 1g/t Au)	
KPBR0101:	1.45 g/t Au over 2 m from 64 m.
KPBR0104	21.21 g/t Au over 3 m from 62 m including 1 m at 54.9 g/t Au over from 62 m.

1) Downhole intervals. Estimated true widths cannot be determined with the available information.

Figure 10-2 Plan view of geochemical anomalies of the Principal Component (PC) 2 Score As-Ag-Pb-Sb-Au based on bottom of hole aircore samples which defines the Sleuth Trend. Element association interpreted to represent primary gold mineralization

Source: CSA Global (2021)

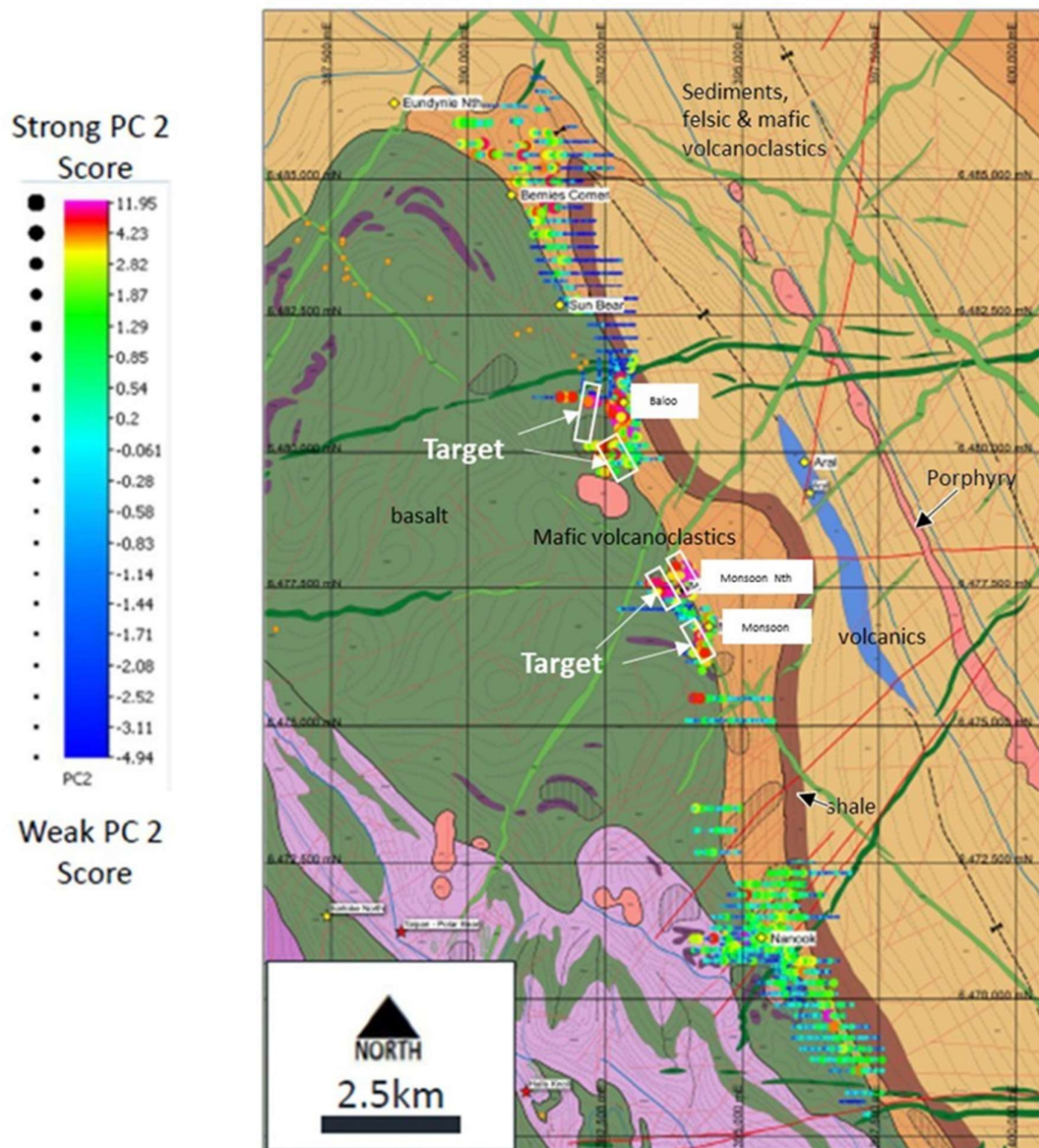
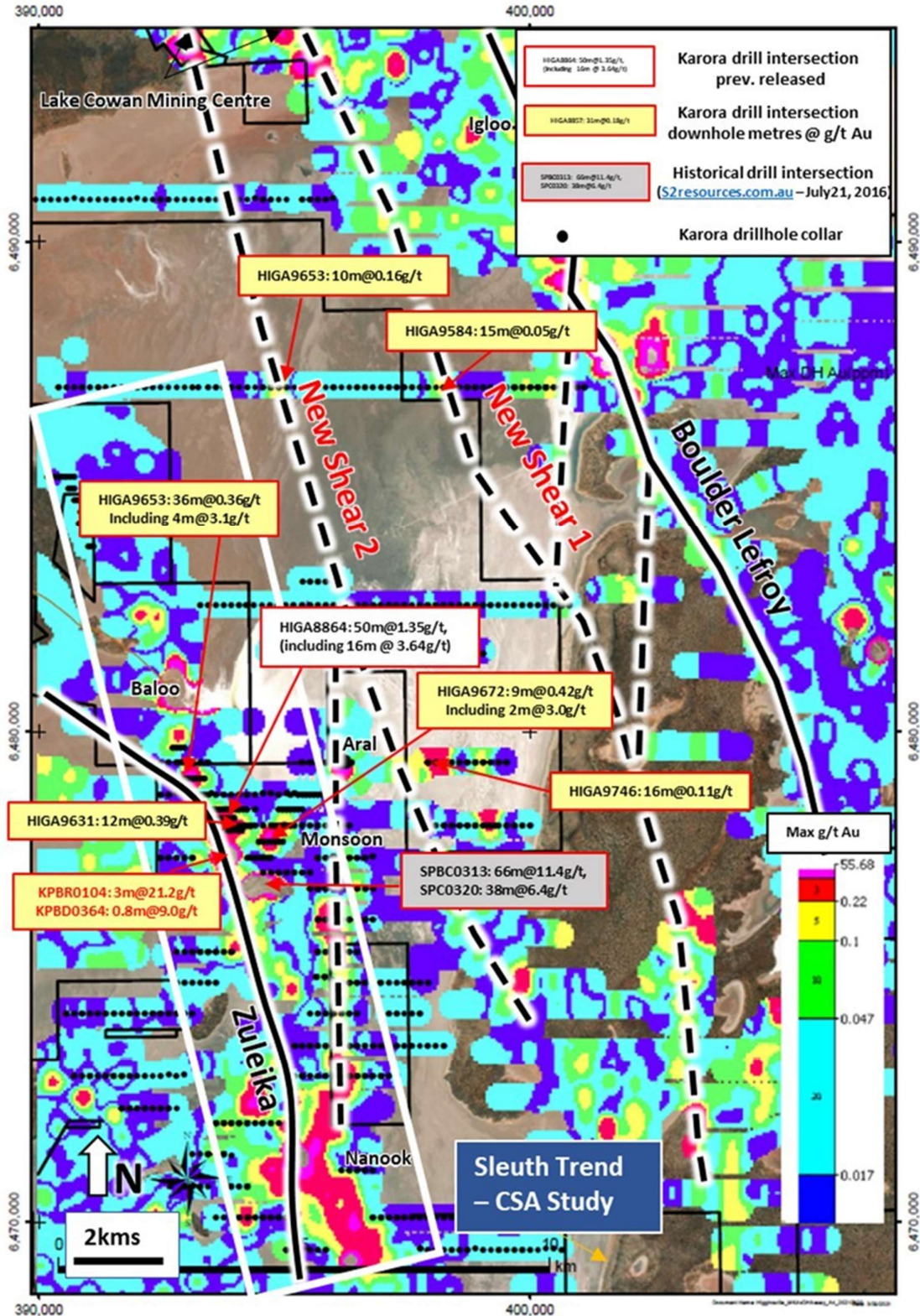

Figure 10-3 Max g/t Au in drill holes overlaid on satellite image of Lake Cowan highlighting selected significant intersections from recently completed drilling and interpreted structures

Source: Karora (2021c)



10.3.2 Spargos Reward

The Spargos Reward project is located 65 km north of Karora's Higginsville Mill by road. The Spargos Reward gold mineralized system is positioned on the contact between meta-greywackes to the east and strongly altered sodic felsic volcanoclastics to the west along a major north trending shear zone which dips steeply to the east. Currently, the resource has been tested to a vertical depth of 600 m with apparent high-grade shoots plunging to the north visible within the deposit.

A total of 20,947 m of combined RC and DD were drilled at Spargos Reward over multiple phases during the reporting period. Significant results from the initial 12,000 m of resource definition drilling are summarised in Table 10-4 (Karora, 2021b). The latest drilling phase comprised four holes of deep DD drilling in late 2022 and early 2023 totalling 2,714 m (Figure 10-4).

Table 10-4 Spargos significant (g X m) intercepts, Phase 1 Resource Definition drilling Nov. – Dec. 2020
 Source: Karora (2021b)

Hole ID	Sub interval	From (m)	To (m)	Downhole Interval (m)	Au (g/t) ¹
SPD 0001		140.5	149	8.5	11.01
	Including	142.75	149	6.3	14
SPDD0002		161	165	4	12.68
SPD 0003		188	202	14	6.06
	Including	196.3	202	5.7	8.6
SPRC0054		43	48	5	8.08
SPRC0062		68	73	5	10.17
SPRC0065		113	125	12	8.96
SPRC0068		41	61	20	3.11
SPRC0069		52	57	5	10.98

1) Downhole intervals. Estimated true widths are approximately 70% of the downhole interval.

Figure 10-4 Drill section of Spargos Reward showing most recent results and best intercepts (estimated true widths). Source (Karora, 2023c)

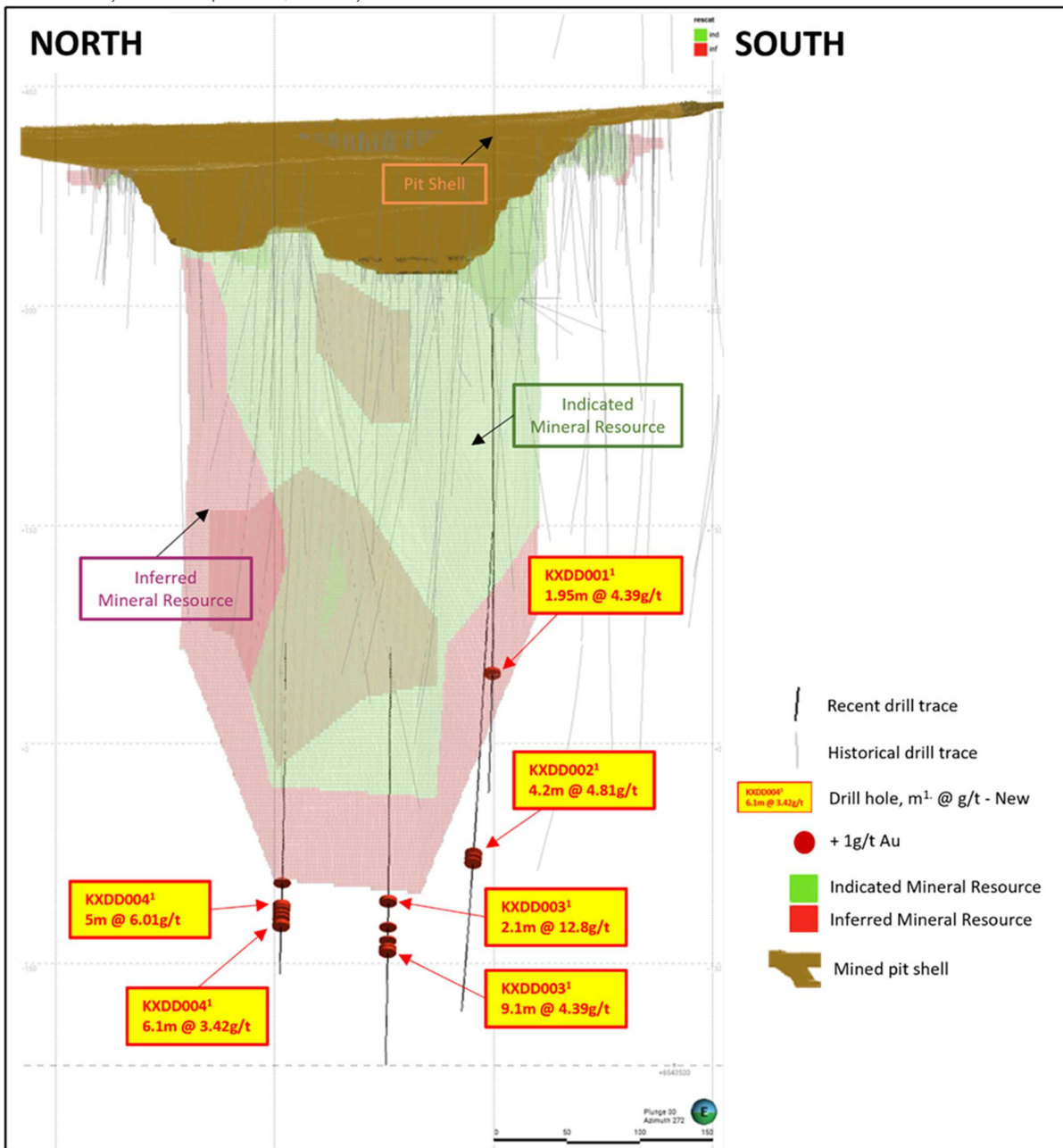

10.3.3 Norcott

In early 2021, an aircore program consisting of 236 holes for 8,551 m drilled on a 180 m by 640 m grid was completed over the project area. The drilling was designed to test the Jeffreys analogue targets selected from aeromagnetic data in 2019–2020.

The drilling was carried out by Gyro Australia. All holes were drilled vertically and were sampled primarily in 4 m intervals. Sample analysis was split between two laboratories: ALS Perth and Bureau Veritas Perth. ALS used their Au-ICP22 method (trace level Au by fire assay and ICP-AES) while Bureau Veritas used AR001 (aqua regia with ICP-MS finish).

All holes penetrated the calcrete/silcrete layer and reached fresh rock at end of hole. A felsic intrusive was intercepted in several holes, as well as minor dolerite. Most of the holes ended in shales or undifferentiated and clast supported meta-sediments. The program took longer to complete than expected due to slow drilling and a deeper than expected average hole depth of 36 m compared to a planned depth of 16 m.

The weathering profile throughout the trend is extensively stripped so a greater emphasis is placed on low tenor results and anything above 10 ppb Au is considered anomalous. Figure 10-5 shows that anomalous grades were intercepted along the entire strike length of the trend and the best results are coincident with the targeted magnetic features.

Best results include:

- 4 m @ 157 ppb Au from 40 m in HIGA9153.
- 12 m @ 22 ppb Au from 36 m in HIGA9133 (including 1 m @ 45 ppb from 44 m); and
- 7 m @ 23 ppb Au from 41 m in HIGA9122.

Full intercepts calculated above 10 ppb Au are included in Table 10-5, and all intercepts displayed in Figure 10-5.

Table 10-5 Significant AC intercepts 2021

Hole_ID	From (m)	To (m)	Width (m)	Grade	Description
HIGA9030	0	6	6	23	6m @ 23 ppb Au
HIGA9030	12	16	4	12	4m @ 12 ppb Au
HIGA9056	28	32	4	11	4m @ 11 ppb Au
HIGA9064	28	32	4	10	4m @ 10 ppb Au
HIGA9065	36	40	4	12	4m @ 12 ppb Au
HIGA9072	40	44	4	15	4m @ 15 ppb Au
HIGA9075	16	24	8	22	8m @ 22 ppb Au
HIGA9101	40	44	4	29	4m @ 29 ppb Au
HIGA9104	24	28	4	11	4m @ 11 ppb Au
HIGA9110	44	48	4	11	4m @ 11 ppb Au
HIGA9111	32	36	4	11	4m @ 11 ppb Au
HIGA9113	36	40	4	17	4m @ 17 ppb Au
HIGA9118	36	40	4	25	4m @ 25 ppb Au
HIGA9120	44	48	4	10	4m @ 10 ppb Au
HIGA9122	28	32	4	11	4m @ 11 ppb Au
HIGA9122	41	48	7	23	7m @ 23 ppb Au
HIGA9130	36	40	4	14	4m @ 14 ppb Au
HIGA9133	36	48	12	22	12m @ 22 ppb Au
HIGA9136	40	44	4	11	4m @ 11 ppb Au
HIGA9140	36	40	4	14	4m @ 14 ppb Au
HIGA9141	44	52	8	19	8m @ 19 ppb Au
HIGA9152	32	40	8	16	8m @ 16 ppb Au
HIGA9153	40	44	4	157	4m @ 157 ppb Au
HIGA9154	44	48	4	30	4m @ 30 ppb Au
HIGA9157	44	47	3	29	3m @ 29 ppb Au
HIGA9161	40	42	2	21	2m @ 21 ppb Au
HIGA9164	44	48	4	12	4m @ 12 ppb Au
HIGA9165	24	28	4	27	4m @ 27 ppb Au
HIGA9180	32	35	3	11	3m @ 11 ppb Au
HIGA9190	28	32	4	11	4m @ 11 ppb Au
HIGA9196	0	4	4	16	4m @ 16 ppb Au
HIGA9199	32	33	1	11	1m @ 11 ppb Au
HIGA9200	0	4	4	10	4m @ 10 ppb Au
HIGA9200	28	32	4	16	4m @ 16 ppb Au
HIGA9201	24	28	4	19	4m @ 19 ppb Au
HIGA9203	28	30	2	13	2m @ 13 ppb Au
HIGA9215	32	36	4	12	4m @ 12 ppb Au
HIGA9232	32	33	1	24	1m @ 24 ppb Au
HIGA9234	28	30	2	52	2m @ 52 ppb Au
HIGA9242	24	28	4	17	4m @ 17 ppb Au
HIGA9259	12	16	4	18	4m @ 18 ppb Au
HIGA9261	8	12	4	11	4m @ 11 ppb Au

Figure 10-5 Norcott Project - 1VD magnetic image highlighting drilling max Au

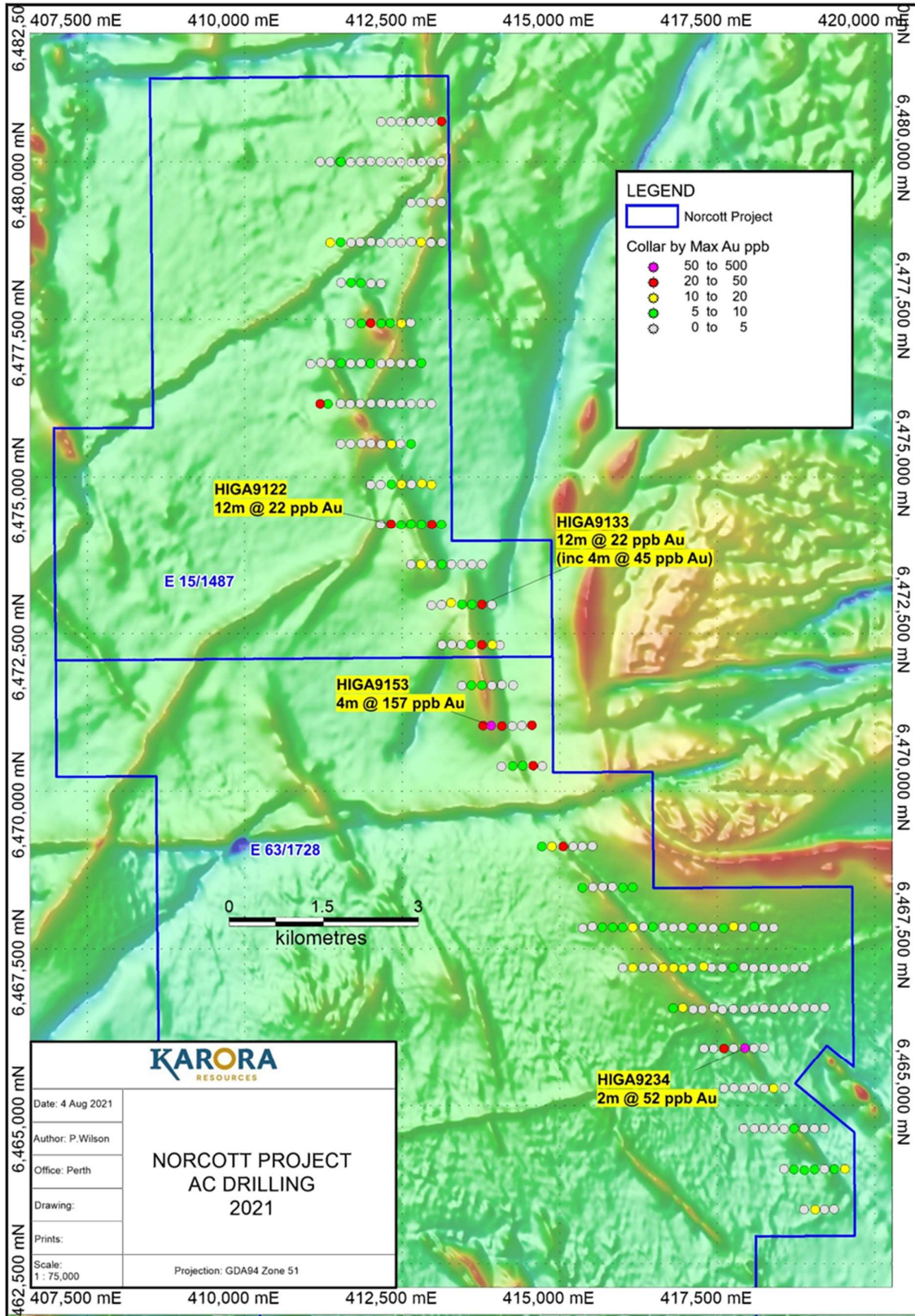

In 2022, 4 m composite sampling was completed over the AC drill spoils from the 2021 Norcott drilling program with the aim of further defining the most prospective target zones over the considerable strike length of the Norcott anomaly. Composite samples were submitted to Bureau Veritas for analysis of 13 pathfinder elements. Received assays were interrogated via ioGas with the hope of producing pathfinder anomalies for future follow-up drilling. This was successful in delivering numerous regions of multi-element anomalism, shown in Figure 10-6.

Figure 10-6 Plan view of 2021 regional AC collars (white triangles) at Norcott, and ioGAS gridded Au/Ag/Sb trends. White zones are priority infill targets, adjacent to interpreted NE fault jog and centered upon chemical sediments.

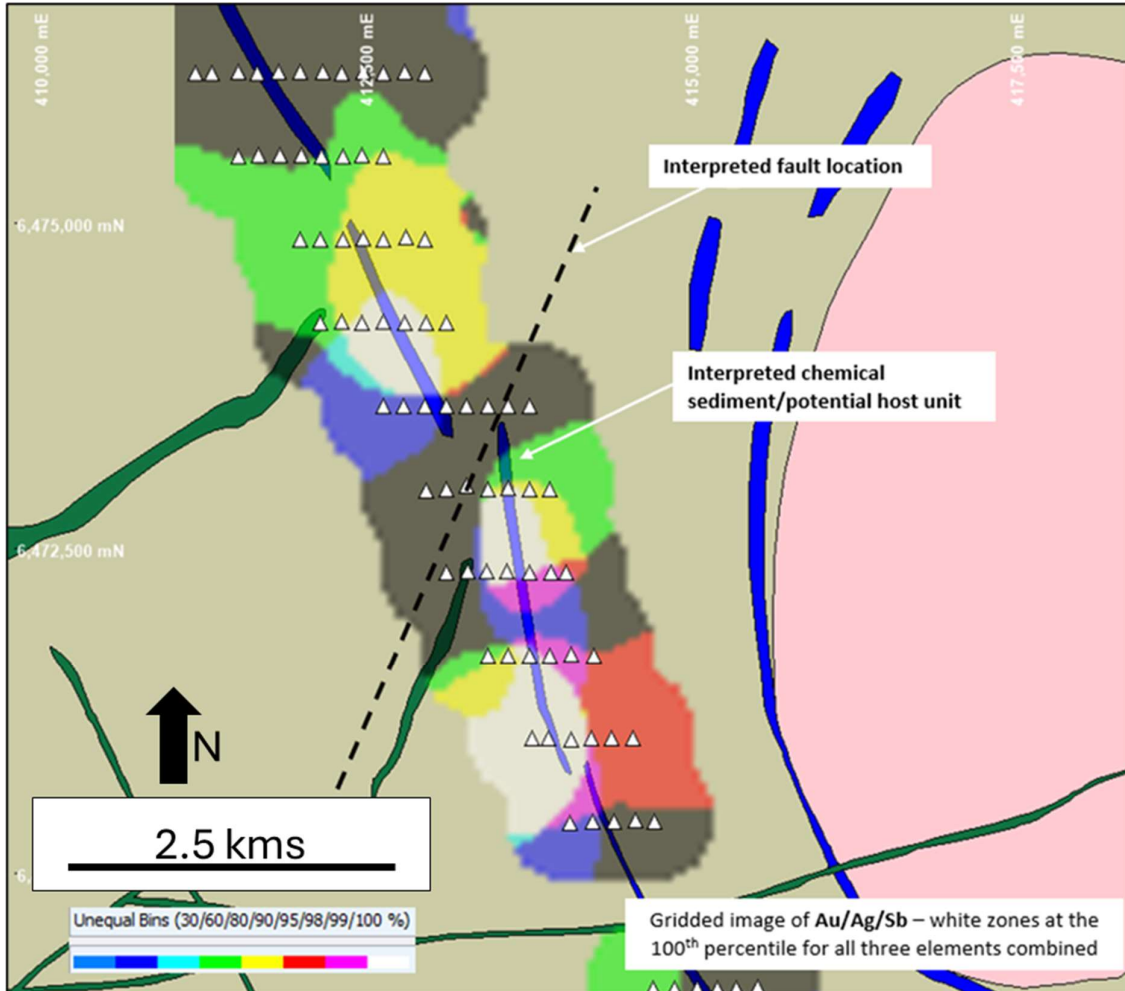

11 SAMPLE PREPARATION, ANALYSIS AND SECURITY

11.1 SAMPLE COLLECTION AND SECURITY

The following sections summarize the drill sample collection processes employed by Karora at HGO for exploration and resource definition drilling:

11.1.1 Aircore (AC)

For aircore (AC) samples prior to 2022, drill cuttings are extracted from the rig return via cyclone. The underflow from each 1 m interval is transferred via bucket to a four-tiered riffle splitter, delivering approximately 3 kg of the recovered material into calico bags for analysis and the residual material into a large green bag. The residual is placed on the ground in 1 m piles. Depending on the program, the samples may be taken in 4 m composites, and if any anomalous assays are received, the 1 m pile is then resampled by spearing the sample.

From 2022, a larger drill rig capable of both AC and RC drilling was used for first pass regional exploration. Two types of rock chip samples are collected at the drill rig. Every metre drilled passes through a cone splitter below the cyclone, after which a 1 m sample is collected from a side shoot into a calico bag, and the bulk sample is collected in a bucket underneath the cyclone. The bucket is emptied onto the ground after which a field technician uses a spear to collect a 4 m composite sample. QA/QC Standards are placed in calicos and are inserted within the composite sequence in the field. A register is recorded within the field at the time of drilling of every sample's unique sample ID number and corresponding metre, as well as the Standard ID when it is first placed into the sequence.

The composite samples are then collected in poly-weave bags and placed within a bulka bag that will be delivered to the correct laboratory via haulage truck. The 1 m splits are stored in plastic field bags close to the corresponding drilled hole.

The composite samples are analysed for gold and multi-elements. Samples are sent to ALS for multi-element aqua regia analysis. (Gold limitation for aqua regia is 4.00 g/t Au; when this occurs the sample is also fire assayed). Upon return of results, intersections of 0.1 g/t and above require their corresponding 1 m splits for further assays. These are taken from the secondary sequence and full QA/QC applied before sending to the laboratory for fire assay.

From July 2022, each hole has an end of hole (EOH) sample submitted for lithogeochemical analysis. Intervals may also be chosen ad-hoc downhole by the logging geologist when necessary for this analysis. Samples are wet sieved, with any quartz veining removed, and the resultant sample spooned into a small brown paper bag numbered with 'holeID_interval metre'.

11.1.2 Reverse Circulation Drilling (RC)

This is a form of percussion drilling designed to eliminate downhole contamination utilising a (nominally) 5¼" face-sampling hammer. Drill cuttings are extracted from the RC return via cyclone. The residual material is retained on the ground near the hole. A cone splitter has typically been used which is located directly below the cyclone, delivering approximately 3 kg of the recovered material into pre-numbered calico bags for analysis. Samples too wet to be split through a splitter are taken as grabs and are recorded as such. The use of a cone splitter is more suitable for wet samples.

From July 2022, a new RC drilling process was used. For every metre drilled, two 1 m splits are collected from the cyclone. Two bag sequences (A) and (B) are utilised. (A) is the primary sequence that will be collected with full QA/QC applied and sent to the Bureau Veritas Kalgoorlie

laboratory for fire assays. The field duplicates for QA/QC are taken from the (B) sequence. The second sequence (B) is left in the field close to the drilled hole and does not have QA/QC applied to it (unless the samples are revisited later for laboratory submission).

A register is recorded within the field at the time of drilling of every sample's unique sample ID number and corresponding meter, as well as the Standard ID when it is first placed into the sequence.

The composite samples are then collected in poly-weave bags and placed within a bulka bag that will be delivered to the correct laboratory via third party haulage truck. Samples are stored securely until they leave site when a goods receipt is created to track the samples.

11.1.3 Diamond Drilling (DD)

Diamond drilling carried out by Karora at Higginsville is logged, sampled and analysed in line with Karora procedures. Diamond drill core is cleaned, laid out, measured and logged on site by geologists for lithology, alteration, mineralisation and structures. Structural measurements, alpha and beta angles, are taken using a kenometer core orientation tool on major lithological contacts, foliations, veins and major fault zones, and are recorded based on orientation lines scribed onto the core by the drillers. Multiple specific gravity (SG) measurements are taken per hole in both ore and waste zones. SGs are taken at a specific gravity weighing station set up at Higginsville. Field technicians, or geologists when necessary, record the Rock Quality Designation (RQD). Logging is entered into LogChief drill hole logging software on field laptop computers and checked into Karora's geological database.

Depending on the project requirements, the diamond core will be drilled to PQ, HQ3, and NQ2 core diameter and either be whole core, half core or quarter core sampled. Sample intervals are based on geology, with a minimum 0.2 m to maximum 1.2 m sample size. Before sampling, diamond core is photographed wet and dry, and the generated files stored electronically on the Karora server. Sampling is performed by a technician in line with sample intervals marked up on the core by a geologist. Core is cut at the sample line and either full, half or quarter core is taken according to the geologist's instructions and placed into numerically marked calico sample bags ready for dispatch to the laboratory, and QA/QC standards and blanks inserted into the series. The half core that is not sent for assaying is stored in the core farm for reference.

11.1.4 Sample Security

Sample security protocols in place aim to maintain the chain of custody of samples to prevent inadvertent contamination or mixing of samples, and to render active tampering as difficult as possible. Sampling is conducted by Karora staff or contract employees under the supervision of site geologists. Samples are placed in calico bags, then placed into poly-weave bags (five at a time) which are then loaded into bulka bags. The bulka bags are collected by a third-party contractor or collected by laboratory transport and driven to the appropriate laboratory. All samples received by the laboratory are physically checked against the dispatch order and Karora personnel are notified of any discrepancies prior to sample preparation commencing. No Karora personnel are involved in the preparation or analysis process.

11.1.5 Prospect Sample Summary

A summary of the prospect, sample type, laboratory and assay method for Higginsville exploration and resource definition drilling can be found in Table 11-1. The majority of samples were sent to Bureau Veritas in Kalgoorlie for fire assay atomic absorption spectroscopy (FA_AAS).

Table 11-1 Sample count for each Higginsville prospect by sample type, laboratory and method

Prospect	Sample Type	Laboratory Code	Assay Method	Sample Count
Ajax North	CHIPS	ALS PERTH	AR_ICPMS	112
		BUREAU VERITAS PERTH	FA_ICPES	172
Ajax South	CHIPS	ALS PERTH	AR_ICPMS	106
Aquarius_HGO	CORE	BUREAU VERITAS KALGOORLIE	FA_AAS	118
		BUREAU VERITAS KALGOORLIE	FA_AAS	2,473
		BUREAU VERITAS PERTH	FA_AAS	162
	RC CHIPS	BUREAU VERITAS KALGOORLIE	FA_AAS	4,033
	WCORE	BUREAU VERITAS KALGOORLIE	FA_AAS	4,882
Baloo	RC CHIPS	BUREAU VERITAS PERTH	FA_AAS	2,412
		BUREAU VERITAS KALGOORLIE	FA_AAS	1,288
Bandido	CHIPS	BUREAU VERITAS PERTH	FA_AAS	10
		ALS PERTH	AR_ICPXS	228
	RC CHIPS	BUREAU VERITAS KALGOORLIE	FA_AAS	19
		BUREAU VERITAS KALGOORLIE	FA_AAS	20
Barcelona	HCORE	INTERTEK PERTH	FA50_AAS	356
			LW_ICPMS	43
	RC CHIPS	BUREAU VERITAS KALGOORLIE	FA_AAS	670
Dundas	RC CHIPS	ALS PERTH	FA50_AAS	2,791
		BUREAU VERITAS PERTH	FA_AAS	188
Eivers	CHIPS	BUREAU VERITAS KALGOORLIE	FA_AAS	903
		ALS PERTH	FA50_AAS	686
Eundynie	RC CHIPS	BUREAU VERITAS KALGOORLIE	FA_AAS	800
Eyre Bend	RC CHIPS	ALS PERTH	FA50_AAS	617
Fairplay	HCORE	BUREAU VERITAS KALGOORLIE	FA_AAS	589
		INTERTEK PERTH	CALC	82
			FA25_ICPTL	82
			FA50_AAS	130
			LW_ICPMS	95
	RC CHIPS	BUREAU VERITAS KALGOORLIE	FA_AAS	1,231
Flynns Island	CHIPS	BUREAU VERITAS PERTH	FA_ICPES	79
Gravel Pit	CHIPS	ALS PERTH	AR_ICPMS	39
Hidden Secret	RC CHIPS	BUREAU VERITAS KALGOORLIE	FA_AAS	2,829
Igloo	RC CHIPS	BUREAU VERITAS KALGOORLIE	FA_AAS	890
Jeffreys South	CHIPS	ALS PERTH	AR_ICPMS	96
		BUREAU VERITAS PERTH	FA_ICPES	28
Josephine	HCORE	INTERTEK PERTH	FA50_AAS	458
		RC CHIPS	BUREAU VERITAS KALGOORLIE	FA_AAS
Lake Cowan	AC CHIPS	ALS PERTH	FA_ICPES	550
		BUREAU VERITAS PERTH	AR_ICPMS	9,231
	HCORE	INTERTEK PERTH	FA50_AAS	232
	RC CHIPS	BUREAU VERITAS KALGOORLIE	FA_AAS	310
		BUREAU VERITAS PERTH	FA_AAS	288
		BUREAU VERITAS KALGOORLIE	FA_AAS	1,260
Magip	RC CHIPS	BUREAU VERITAS KALGOORLIE	FA_AAS	1,260

Prospect	Sample Type	Laboratory Code	Assay Method	Sample Count
		BUREAU VERITAS PERTH	FA_AAS	600
Mouse Hollow	HCORE	BUREAU VERITAS KALGOORLIE	FA_AAS	649
	CORE	BUREAU VERITAS KALGOORLIE	FA_AAS	43
	RC CHIPS	BUREAU VERITAS KALGOORLIE	FA_AAS	2,640
	WCORE	BUREAU VERITAS KALGOORLIE	FA_AAS	917
No Secret	RC CHIPS	BUREAU VERITAS KALGOORLIE	FA_AAS	2,509
Norcott	AC CHIPS	ALS PERTH	FA_ICPES	211
		BUREAU VERITAS PERTH	AR_ICPMS	2,181
Pioneer One	CHIPS	ALS PERTH	AR_ICPXS	470
		BUREAU VERITAS KALGOORLIE	FA_AAS	2,518
	QCORE	BUREAU VERITAS KALGOORLIE	FA_AAS	453
	RC CHIPS	BUREAU VERITAS KALGOORLIE	FA_AAS	2,305
Porphyry	RC CHIPS	BUREAU VERITAS KALGOORLIE	FA_AAS	295
		BUREAU VERITAS PERTH	FA_AAS	765
Porphyry 6	CHIPS	ALS PERTH	AR_ICPMS	911
		BUREAU VERITAS PERTH	FA_ICPES	88
Poseidon South	RC CHIPS	BUREAU VERITAS KALGOORLIE	FA_AAS	1,014
Rainer	CHIPS	ALS PERTH	AR_ICPMS	1,688
		BUREAU VERITAS KALGOORLIE	FA_AAS	58
		BUREAU VERITAS PERTH	FA_ICPES	74
Regional	CHIPS	ALS PERTH	AR_ICPXS	36
Republican	RC CHIPS	ALS PERTH	FA50_AAS	277
		BUREAU VERITAS PERTH	FA_AAS	270
Sinclair Soak	HCORE	INTERTEK PERTH	FA50_AAS	233
Spargos Reward	HCORE	BUREAU VERITAS KALGOORLIE	FA_AAS	4,352
		BUREAU VERITAS PERTH	FA_AAS	637
	CORE	BUREAU VERITAS KALGOORLIE	FA_AAS	139
	RC CHIPS	BUREAU VERITAS KALGOORLIE	FA_AAS	10,261
	WCORE	BUREAU VERITAS KALGOORLIE	FA_AAS	1,844
Spargos South	HCORE	BUREAU VERITAS KALGOORLIE	FA_AAS	442
	RC CHIPS	BUREAU VERITAS KALGOORLIE	FA_AAS	2,569
	WCORE	BUREAU VERITAS KALGOORLIE	FA_AAS	170
Spargos Sterilisation	COMP_CH	BUREAU VERITAS KALGOORLIE	FA_AAS	60
	RC CHIPS	BUREAU VERITAS KALGOORLIE	FA_AAS	660
Spongelite	CHIPS	ALS PERTH	AR_ICPXS	181
Swagman	HCORE	BUREAU VERITAS PERTH	BLG_ICPMS	71
			FA_AAS	635
	RC CHIPS	BUREAU VERITAS KALGOORLIE	FA_AAS	1,827
		BUREAU VERITAS PERTH	BLG_ICPMS	2
			FA_AAS	221
	WCORE	BUREAU VERITAS PERTH	FA_AAS	866
Syenite	AC CHIPS	BUREAU VERITAS PERTH	AR_ICPMS	679
Trident	HCORE	BUREAU VERITAS KALGOORLIE	FA_AAS	521

Prospect	Sample Type	Laboratory Code	Assay Method	Sample Count
	RC CHIPS	BUREAU VERITAS KALGOORLIE	FA_AAS	1,574
	WCORE	BUREAU VERITAS KALGOORLIE	FA_AAS	487
Two Boys	CORE	BUREAU VERITAS KALGOORLIE	FA_AAS	190
	HCORE	BUREAU VERITAS KALGOORLIE	FA_AAS	1,204
		BUREAU VERITAS PERTH	FA_AAS	431
		HIGGINSVILLE	AR_AAS	51
	RC CHIPS	BUREAU VERITAS KALGOORLIE	FA_AAS	2,702
		BUREAU VERITAS PERTH	FA_AAS	1,229
	WCORE	BUREAU VERITAS KALGOORLIE	FA_AAS	2,538
		BUREAU VERITAS PERTH	FA_AAS	525
White Dam	CHIPS	BUREAU VERITAS PERTH	FA_ICPES	231
Wishbone	CHIPS	ALS PERTH	AR_ICPXS	24
Zebra Hill	CHIPS	ALS PERTH	AR_ICPMS	310
Grand Total				101,270

11.2 LABORATORY SAMPLE PREPARATION, ASSAYING AND ANALYTICAL PROCEDURES

Samples were processed at the independent commercial laboratories listed in Table 11-2. In addition, 51 samples were processed at the Higginsville minesite.

Table 11-2 Independent commercial laboratories

Laboratory	Address	Comment
Australian Laboratory Services (ALS Perth Malaga)	31 Denninup Way Malaga WA 6090	Accreditation Status: ISO/IEC 17025 Accrediting Body: NATA Corporate Accreditation No: 825 Corporate Site No: 23001
Australian Laboratory Services (ALS Perth Wangara)	79 Distinction Road Wangara WA 6065	Sample Preparation Facility
Australian Laboratory Services (ALS Kalgoorlie)	5 Keogh Way Kalgoorlie WA 6430	Accreditation Status: ISO 9001.2015 Accrediting Body: LRQA
Bureau Veritas (BV Kalgoorlie)	22 Cunningham Dr West Kalgoorlie WA 6430	Accreditation Status: ISO 9001.2015 Accrediting Body: TUV NORD
Bureau Veritas (BV Kalgoorlie)	18 Atbara Street Kalgoorlie WA 6430	Accreditation Status: ISO 9001.2015 Accrediting Body: TUV NORD
Bureau Veritas (BV Perth)	6 Gauge Circuit, Canning Vale Perth WA 6155	Accreditation Status: ISO/IEC 17025 (2005) Accrediting Body: NATA Corporate Accreditation No: 626 Corporate Site No: 18466
Bureau Veritas (BV Perth)	58 Sorbonne Crescent Canning Vale Perth, WA 6155	Accreditation Status: ISO/IEC 17025 (2005) Accrediting Body: NATA Corporate Accreditation No: 626 Corporate Site No: 14517
Intertek (Intertek Perth)	544 Bickley Road Maddington, Perth, Western Australia 6109	Accreditation status: ISO/IEC 17025 Accrediting Body: NATA Corporate Accreditation No: 3244 Corporate Site No: 3237

A summary of the laboratory and assay methods are shown in Table 11-3. The majority of samples were sent to Bureau Veritas in Kalgoorlie for fire assay atomic absorption spectroscopy (FA_AAS).

Table 11-3 Summary of laboratories used and assay method

Assay Type	Assay Code	Assay Description	Laboratory	Sample Count
Fire Assay	FA_AAS	Fire assay 40g, AAS finish	Bureau Veritas - Kalgoorlie	68,100
	FA_AAS	Fire assay 40g, AAS finish	Bureau Veritas - Perth	9,239
	FA_ICPES	Fire assay 40g, ICP-OES finish	Bureau Veritas - Perth	672
	FA50_AAS	Fire assay 50g, AAS finish	ALS - Perth	4,371
	FA_ICPES	Fire assay 50g, ICP-OES finish	ALS - Perth	761
	FA50_AAS	Fire assay 50g, AAS finish	Intertek - Perth	1,409
Recovery	BLG_ICPMS	Bulk leach extractable gold by cyanide leach, ICP-MS finish	Bureau Veritas - Perth	73
	LW_ICPMS	Leachwell accelerated cyanide leach, ICP-MS finish	Intertek - Perth	138
	FA25_ICPTL	Fire assay 25g, ICP-OES finish on Leachwell tail	Intertek - Perth	82
	CALC	Calculated result from Leachwell and tail	Intertek - Perth	82
Aqua Regia	AR_ICPMS	Aqua regia digest, ICP-MS finish	ALS - Perth	3,262
	AR_ICPXS	Aqua regia digest, ICP-MS/ICP-OES finish	ALS - Perth	939
	AR_ICPMS	Aqua regia digest, ICP-MS finish	Bureau Veritas - Perth	12,091
	AR_AAS	Aqua regia digest, AAS finish	Higginsville Laboratory	51
Grand Total				101,270

11.2.1 Fire Assay

All geological samples requiring Au fire assaying are sent off site to a commercial laboratory for analysis (Figure 11-1). The entire dried sample is jaw crushed (JC2500 or Boyd Crusher) to a nominal 85% passing 4 mm with crushing equipment cleaned between samples. The sample is then split using an Integral RSD to produce a product <3 kg, the remainder of the sample is stored as the coarse reject. The sample is then pulverised in a LM5 ring mill to grind the sample to a nominal 90% passing 75 µm particle size. A charge of 40 g is taken and flux added, and fired in a reduction furnace to produce a button. It is then further fired in a muffle furnace to produce a doré bead. The doré bead is then dissolved, and silver separated from the gold in solution. The resulting liquor is then analysed for gold content by organic extraction with flame AAS finish, with an overall method detection limit of 0.01 ppm Au content in the original sample.

Figure 11-1 Representative fire assay sample flow chart Bureau Veritas Kalgoorlie

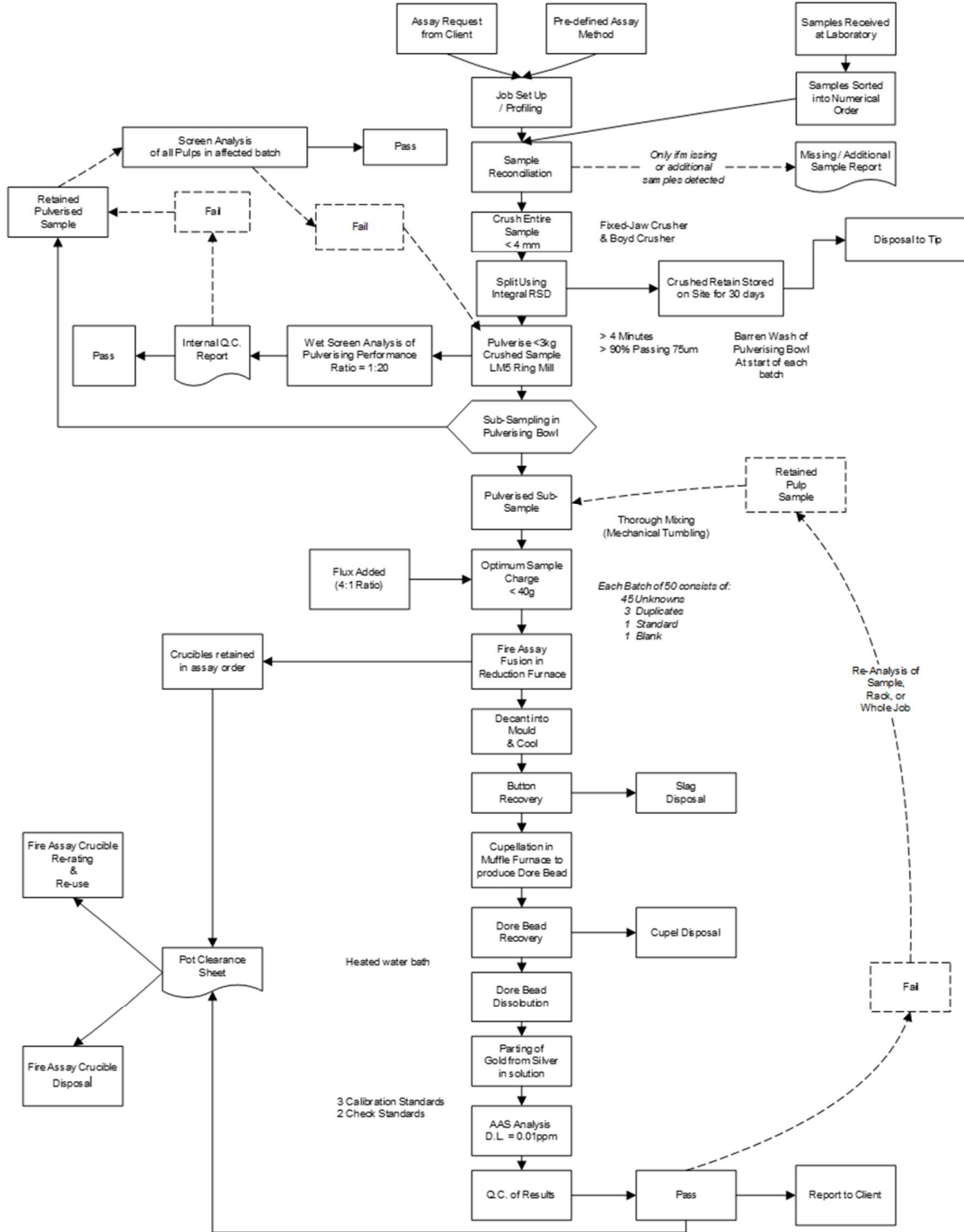

11.2.2 Recovery Techniques

11.2.2.1 Intertek Perth - Leachwell

Preparation - Sample dried, crushed and pulverised using LM5.

Analysis:

- LW400/OE - cyanide leach by Leachwell (400g). Analysed by inductively coupled plasma mass spectrometry.
- FA25T/OE - 25g lead collection fire assay for recovered tails. Analysed by inductively coupled plasma mass spectrometry.
- WT01 - reporting weights of samples.
- LWtot Au total (LW400/OE + FA25T/OE tail recovery).

11.2.2.2 Bureau Veritas Perth - Mini-BLEGS

Preparation

- Sample sorted and dried.
- Crushed (if required) to 3 mm, split to 2.4 kg and pulverise.
- Pulp packet taken for fire assay or wet chemistry.
- Pulp residue used for Bleg.

Bleg Analysis

- Sample weighed.
- Cyanide solution added.
- pH adjusted/maintained using lime.
- Tumbled for 24 hours (leached).
- Allowed to settle for 8 hours.
- Sub-sample taken and run on ICP-MS.

11.2.3 Aqua Regia

For aqua regia, the entire dried sample is jaw crushed (JC2500 or Boyd Crusher) to a nominal 85% passing 4 mm with crushing equipment cleaned between samples. The sample is then split using an Integral RSD to produce a product <3 kg and the remainder of the sample is stored as the coarse reject. The sample is then pulverised in a LM5 ring mill to grind the sample to a nominal 90% passing 75 µm particle size. A sub-sample of 200 mg is taken from the pulped sample in the high wet strength paper packet; this is the assay weight. The actual weight is recorded and is included in the results calculation process. The aqua regia chemicals (nitric acid and hydrochloric acid) are then added to the crushed sub-sample and left to dissolve. The resulting liquid is then analysed for gold and/or multi-element content using either AAS, or inductively coupled plasma (ICP) spectroscopy with an overall method detection limit of 0.02 ppm Au content in the original sample.

11.3 QUALITY CONTROL PROCEDURES AND QUALITY ASSURANCE

11.3.1 Quality Control Procedures

QA/QC consists of regular insertion and submission of blank and certified standard material (CRMs), as well as regular repeat analysis of the course reject material. As a minimum standard, at least one blank is inserted every 50 samples and at least one CRM is inserted every 20 samples. In addition, internal laboratory standard reference material is also regularly analysed at a rate of 1 in every 20 samples.

QA/QC assay results are reviewed by the geologist in charge of each prospect as the assays are delivered to site. In addition, weekly and monthly reports are generated by the database administrator for the geology team, including control charts for assays returned for standards and blanks, and comparison plots of duplicate assays.

When assays are imported into Karora's geological database, the standards and blanks are automatically checked and pass/fail criteria applied. If a batch fails, it is assessed for possible reasons and the procedure specifies the following appropriate actions:

- The sample cutsheet is checked for errors or misallocation of standard.
- A single failure with no apparent cause, in a length of waste, may be accepted by the Authorised Person (Senior Geologist).
- A failure near or in a length of mineralisation, will result in a request to the laboratory for re-assay of relevant samples by the Authorised Person (Senior Geologist). The re-assayed results will be re-loaded and checked against QA/QC again.
- The actions taken are recorded against the standard sample in the database.

All assays are loaded into the live database. Those assays with outstanding QA/QC queries, after the above procedures, are assessed and can be excluded from the resource estimation process.

Table 11-4 Karora-inserted CRM and blank standards for gold for the reporting period to July 2023

Standard	Element	Unit	Method	Expected Value	Standard Deviation	Au -3SD	Au +3SD
AVO_Blank	Au	ppm	Fire Assay	0.005	0.015	0	0.05
BLANK_RD1	Au	ppm	Fire Assay	0.005	0.015	0	0.05
BUN_BLANK	Au	ppm	Fire Assay	0.005	0.015	0	0.05
G302-3	Au	ppm	Fire Assay	2.33	0.12	1.97	2.69
G308-2	Au	ppm	Fire Assay	1.07	0.06	0.89	1.25
G313-4	Au	ppm	Fire Assay	2	0.08	1.76	2.24
G313-8	Au	ppm	Fire Assay	2.43	0.11	2.1	2.76
G314-3	Au	ppm	Fire Assay	6.7	0.21	6.07	7.33
G314-9	Au	ppm	Fire Assay	1.52	0.06	1.34	1.7
G315-1	Au	ppm	Fire Assay	5.64	0.25	4.89	6.39
G315-8	Au	ppm	Fire Assay	9.93	0.32	8.97	10.89
G318-3	Au	ppm	Fire Assay	0.72	0.03	0.63	0.81
G318-8	Au	ppm	Fire Assay	0.79	0.03	0.7	0.88
G319-4	Au	ppm	Fire Assay	0.5	0.03	0.41	0.59
G901-5	Au	ppm	Fire Assay	1.65	0.07	1.44	1.86
G905-7	Au	ppm	Fire Assay	3.92	0.15	3.47	4.37
G909-6	Au	ppm	Fire Assay	0.57	0.03	0.48	0.66

Standard	Element	Unit	Method	Expected Value	Standard Deviation	Au -3SD	Au +3SD
G910-1	Au	ppm	Fire Assay	1.43	0.06	1.25	1.61
G910-2	Au	ppm	Fire Assay	0.9	0.05	0.75	1.05
G910-6	Au	ppm	Fire Assay	3.09	0.13	2.7	3.48
G910-9	Au	ppm	Fire Assay	1.51	0.06	1.33	1.69
G911-10	Au	ppm	Fire Assay	1.3	0.05	1.15	1.45
G912-7	Au	ppm	Fire Assay	0.42	0.02	0.36	0.48
G914-2	Au	ppm	Fire Assay	2.48	0.08	2.24	2.72
G914-7	Au	ppm	Fire Assay	9.81	0.3	8.91	10.71
G915-6	Au	ppm	Fire Assay	0.67	0.04	0.55	0.79
G916-6	Au	ppm	Fire Assay	30.94	0.87	28.33	33.55

11.3.2 Quality Control Analysis

11.3.2.1 Laboratory Summary

During the reporting period from October 2020 to July 2023, a total of 704 sample batches were submitted for gold fire assay to Bureau Veritas, ALS and Intertek laboratories as summarised in Table 11-5. These represented 100,937 drill hole samples, 6,272 field duplicates and 14,987 Company certified standards and blanks. Results are summarised in the following tables and charts. No significant issues were noted other than the occasional outliers which were individually investigated and resolved.

Table 11-5 Laboratory summary for Au fire assay October 1, 2020 to July 2, 2023

Laboratories	ALS Perth	Bureau Veritas Kalgoorlie	Bureau Veritas Perth	Intertek Perth
No. of Batches	69	448	170	17
No. of DH Samples	7,004	67,509	24,933	1,491
No. of QC Samples	306	4,165	1,746	55
No. of Standard Samples	1,179	11,217	2,369	222

Figure 11-2 Standards – sRPD box and whisker plot Au fire assay AAS Bureau Veritas Kalgoorlie

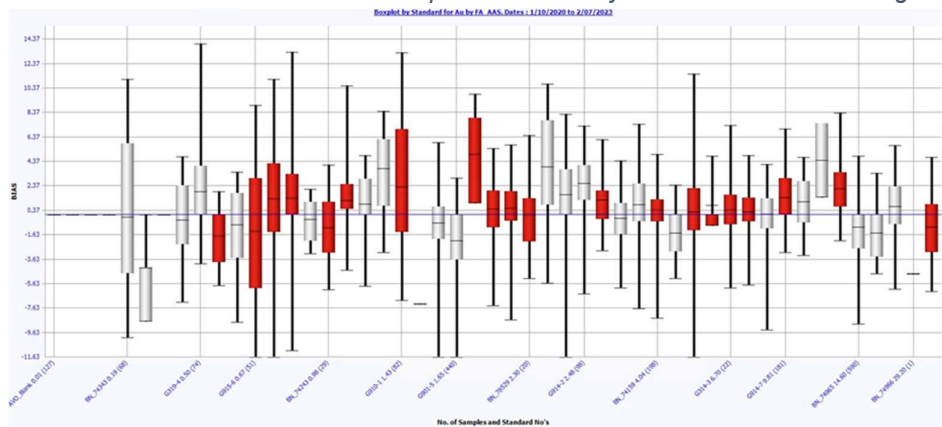

Figure 11-3 Standards – sRPD box and whisker plot Au fire assay AAS Bureau Veritas Perth

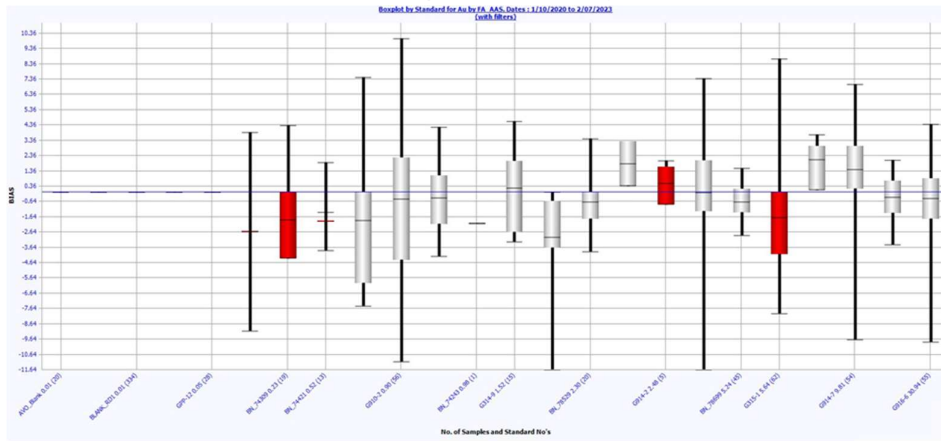

Figure 11-4 Standards – sRPD box and whisker plot Au fire assay 50g AAS ALS Perth and Intertek Perth

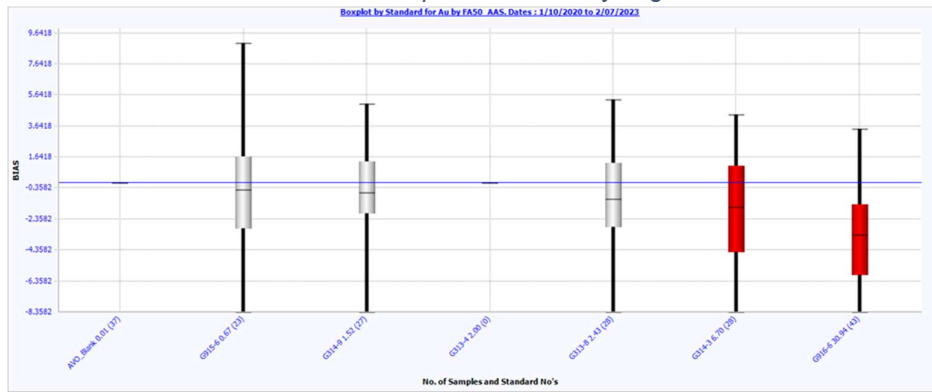
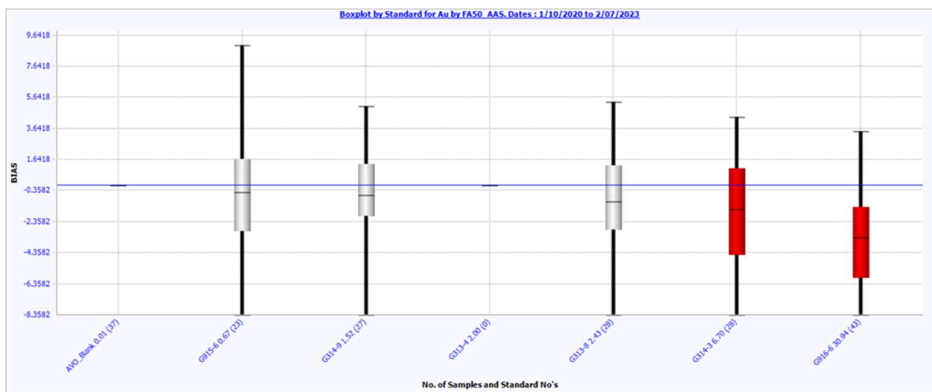

Figure 11-5 Standards – sRPD box and whisker plot Au fire assay ICP-OES ALS Perth and Bureau Veritas Perth



11.3.2.2 Karora Submitted Au Blanks Fire Assay

Table 11-6 Karora submitted Au blanks for fire assay all laboratories, October 1, 2020 to July 2, 2023

Au Standard(s)					No. of Samples	Calculated Values			
Std Code	Method	Exp Method	Exp Value	Exp SD		Mean Au	SD	CV	Mean Bias
AVO_Blank	FA_AAS	FA_AAS	0.0050	0.0150	157	0.0211	0.1943	9.2025	322.29%
AVO_Blank	FA_ICPES	FA_ICPES	0.0050	0.0150	6	0.0034	0.0036	1.0488	-31.67%
AVO_Blank	FA50_AAS	FA50_AAS	0.0050	0.0150	73	0.0096	0.0203	2.1157	91.92%
BLANK_RD1	FA_AAS	FA_AAS	0.0050	0.0150	2229	0.0139	0.2005	14.4288	177.97%
BUN_BLANK	FA_AAS	FA_AAS	0.0050	0.0150	742	0.0056	0.0025	0.4481	12.13%

Figure 11-6 Karora submitted Au blanks for fire assay all laboratories, October 1, 2020 to July 2, 2023

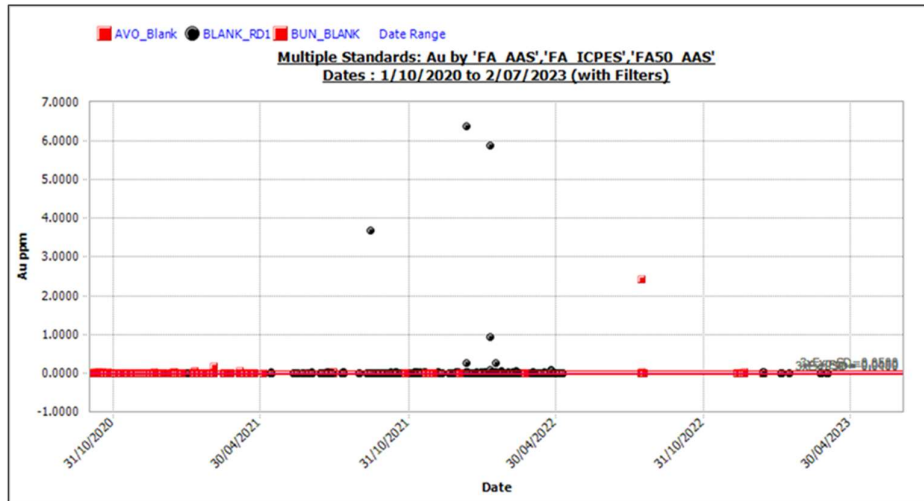

11.3.2.3 Karora Submitted Au Standards Fire Assay

Table 11-7 Karora submitted Au Standards for fire assay AAS Bureau Veritas Kalgoorlie and Perth, October 1, 2020 to July 2, 2023

Au Standard(s)					No. of Samples	Calculated Values			
Std Code	Method	Exp Method	Exp Value	Exp SD		Mean Au	SD	CV	Mean Bias
G302-3	FA_AAS	FA_AAS	2.3300	0.1200	21	2.2381	0.5878	0.2626	-3.94%
G313-8	FA_AAS	FA_AAS	2.4300	0.1100	26	2.4385	0.2090	0.0857	0.35%
G314-3	FA_AAS	FA_AAS	6.7000	0.2100	28	6.7107	1.0382	0.1547	0.16%
G314-9	FA_AAS	FA_AAS	1.5200	0.0600	63	1.5063	0.1973	0.1310	-0.90%
G315-1	FA_AAS	FA_AAS	5.6400	0.2500	455	5.5682	0.6729	0.1208	-1.27%
G315-8	FA_AAS	FA_AAS	9.9300	0.3200	25	10.0372	0.2134	0.0213	1.08%
G316-7	FA_AAS	FA_AAS	5.8500	0.1900	4	5.8975	0.1565	0.0265	0.81%
G318-3	FA_AAS	FA_AAS	0.7200	0.0300	21	0.7295	0.0381	0.0523	1.32%
G319-4	FA_AAS	FA_AAS	0.5000	0.0300	78	0.5165	0.0661	0.1279	3.31%
G901-5	FA_AAS	FA_AAS	1.6500	0.0700	528	1.8064	1.9775	1.0948	9.48%

Au Standard(s)					No. of Samples	Calculated Values			
Std Code	Method	Exp Method	Exp Value	Exp SD		Mean Au	SD	CV	Mean Bias
G905-7	FA_AAS	FA_AAS	3.9200	0.1500	492	4.0401	1.6863	0.4174	3.06%
G909-6	FA_AAS	FA_AAS	0.5700	0.0300	9	0.5656	0.0224	0.0396	-0.78%
G910-1	FA_AAS	FA_AAS	1.4300	0.0600	84	1.4428	0.1845	0.1279	0.89%
G910-2	FA_AAS	FA_AAS	0.9000	0.0500	561	1.0700	1.8781	1.7553	18.89%
G910-6	FA_AAS	FA_AAS	3.0900	0.1300	25	3.0396	0.4424	0.1456	-1.63%
G910-9	FA_AAS	FA_AAS	1.5100	0.0600	1	1.4000	0.0000	0.0000	-7.28%
G911-10	FA_AAS	FA_AAS	1.3000	0.0500	70	1.3547	0.1300	0.0959	4.21%
G912-7	FA_AAS	FA_AAS	0.4200	0.0200	24	0.8175	1.9138	2.3410	94.64%
G914-2	FA_AAS	FA_AAS	2.4800	0.0800	105	2.5183	0.1951	0.0775	1.54%
G914-7	FA_AAS	FA_AAS	9.8100	0.3000	250	9.6792	2.0434	0.2111	-1.33%
G915-6	FA_AAS	FA_AAS	0.6700	0.0400	80	1.6934	5.0716	2.9949	152.75%
G916-6	FA_AAS	FA_AAS	30.9400	0.8700	449	30.1867	3.5352	0.1171	-2.43%

Figure 11-7 Standard G315-1: outliers included

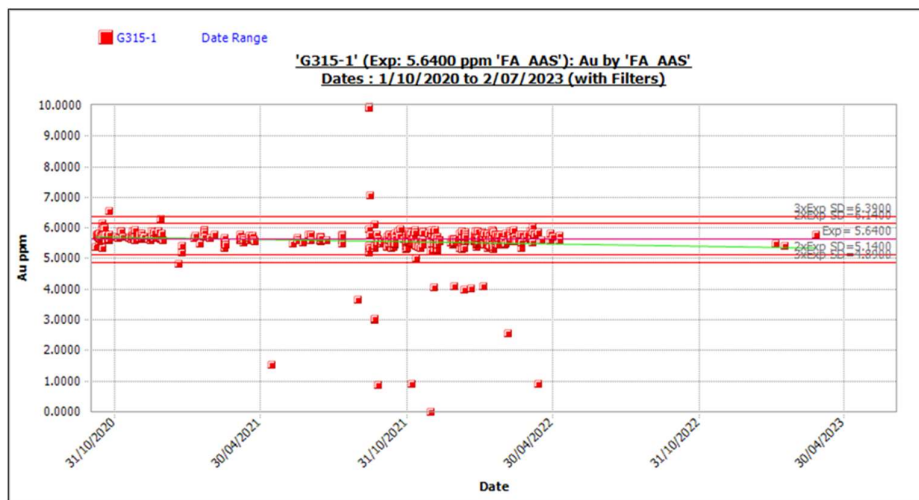

Figure 11-8 Standard G901-5: outliers included

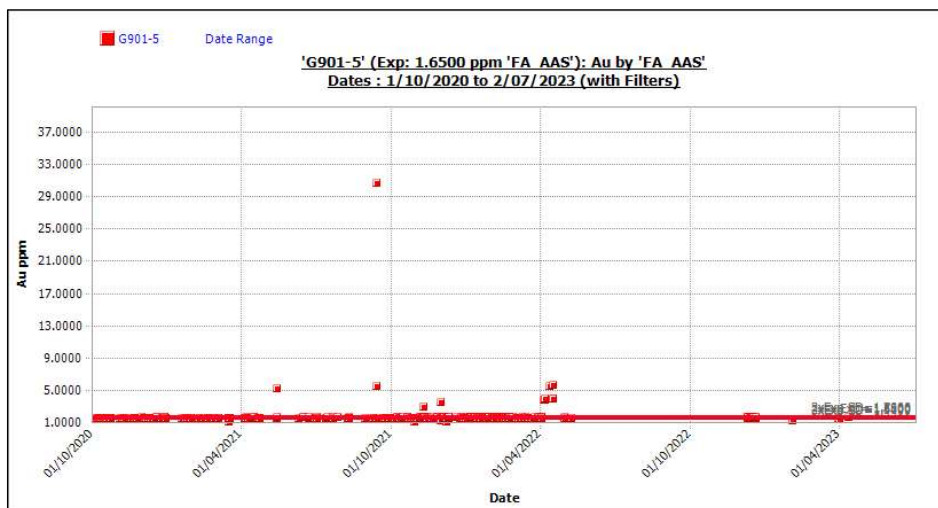

Figure 11-9 Standard G905-7: outliers included

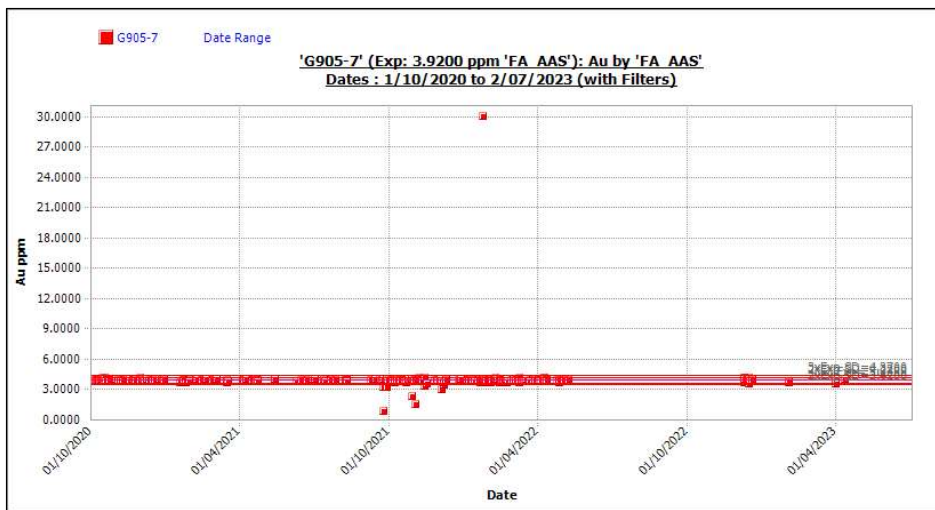

Figure 11-10 Standard G910-2: outliers included

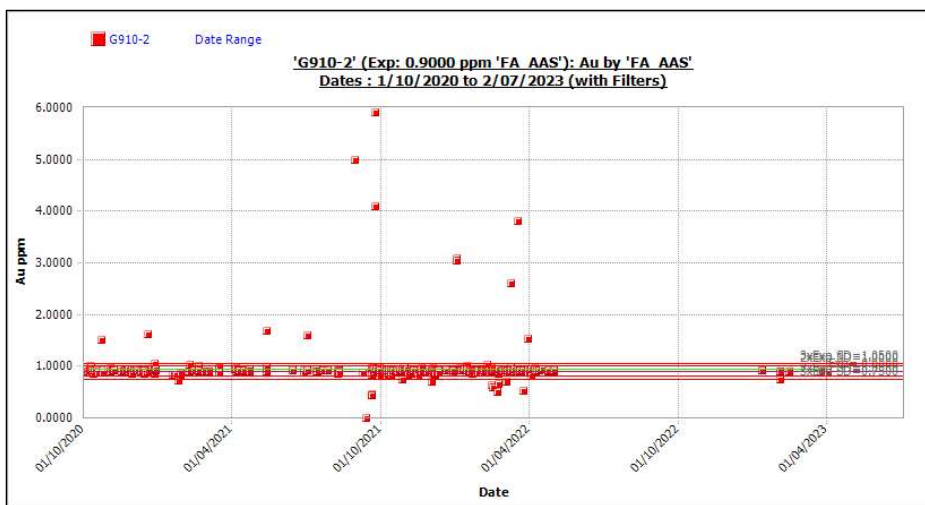

Figure 11-11 Standard G914-7: outliers included

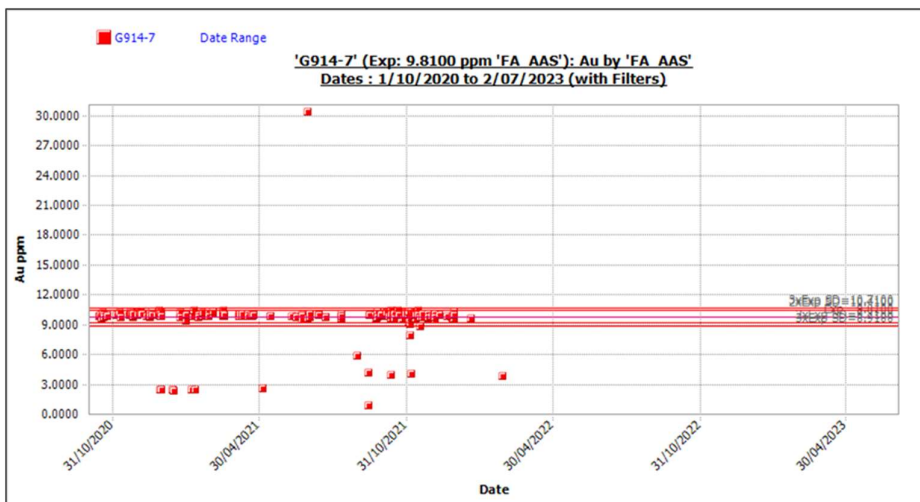

Figure 11-12 Standard G916-6: outliers included

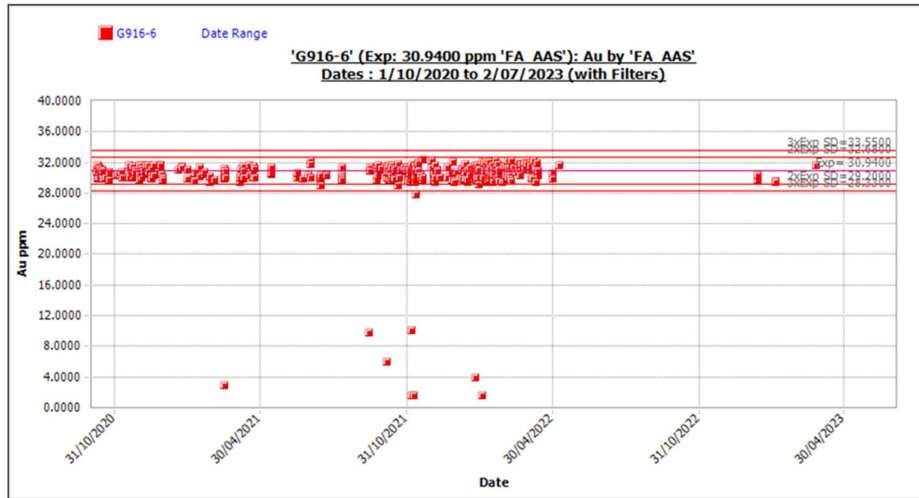

Table 11-8 Karora submitted Au Standards for fire assay 50g ALS Perth and Intertek Perth, October 1, 2020 to July 2, 2023

Au Standard(s)					No. of Samples	Calculated Values			
Std Code	Method	Exp Method	Exp Value	Exp SD		Mean Au	SD	CV	Mean Bias
G313-4	FA50_AAS	FA50_AAS	2.0000	0.0800	1	2.5060	0.0000	0.0000	25.30%
G313-8	FA50_AAS	FA50_AAS	2.4300	0.1100	28	2.4006	0.0862	0.0359	-1.21%
G314-3	FA50_AAS	FA50_AAS	6.7000	0.2100	28	6.5935	0.2596	0.0394	-1.59%
G314-9	FA50_AAS	FA50_AAS	1.5200	0.0600	30	1.6818	0.9955	0.5919	10.65%
G909-6	FA50_AAS	FA50_AAS	0.5700	0.0300	10	0.5661	0.0100	0.0177	-0.68%
G914-2	FA50_AAS	FA50_AAS	2.4800	0.0800	10	2.2540	0.5739	0.2546	-9.11%
G914-9	FA50_AAS	FA50_AAS	16.6200	0.7200	1	1.5200	0.0000	0.0000	-90.85%
G915-6	FA50_AAS	FA50_AAS	0.6700	0.0400	27	0.8263	0.4991	0.6041	23.33%
G916-6	FA50_AAS	FA50_AAS	30.9400	0.8700	45	28.6324	5.9696	0.2085	-7.46%

Figure 11-13 Standard G313-8: outliers included

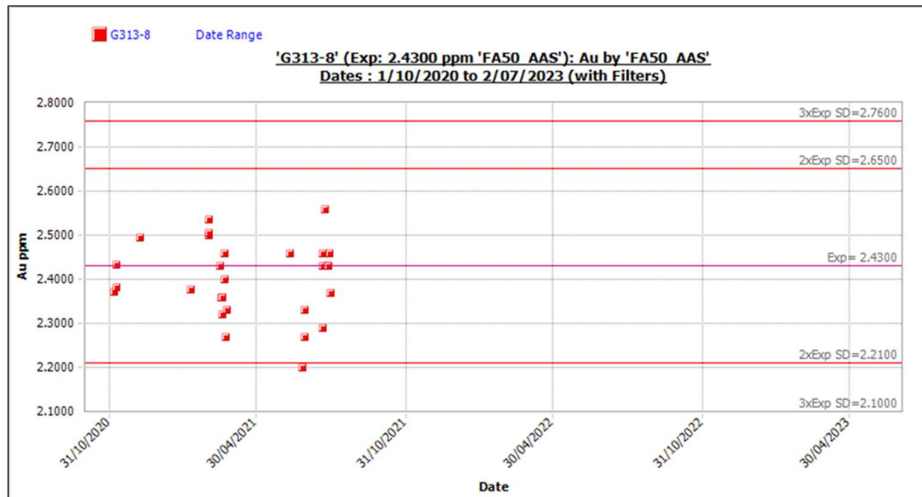

Figure 11-14 Standard G314-3: outliers included

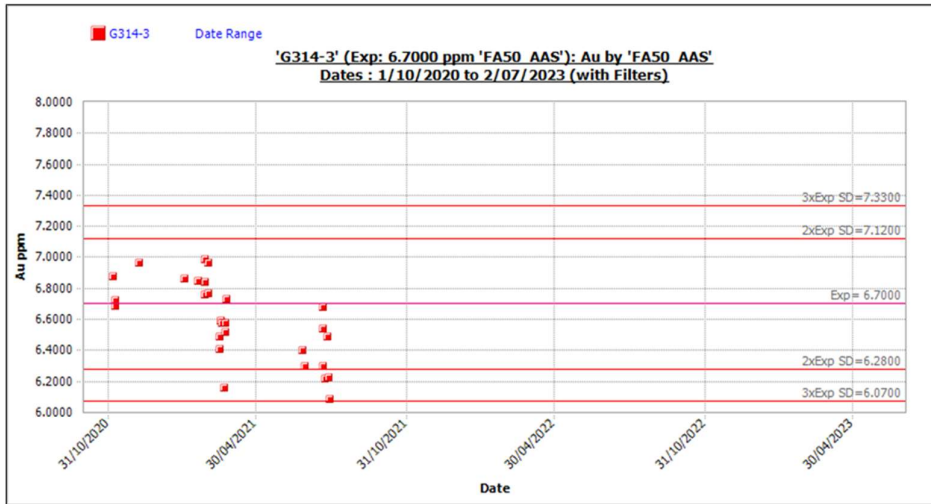

Figure 11-15 Standard G314-9: outliers included

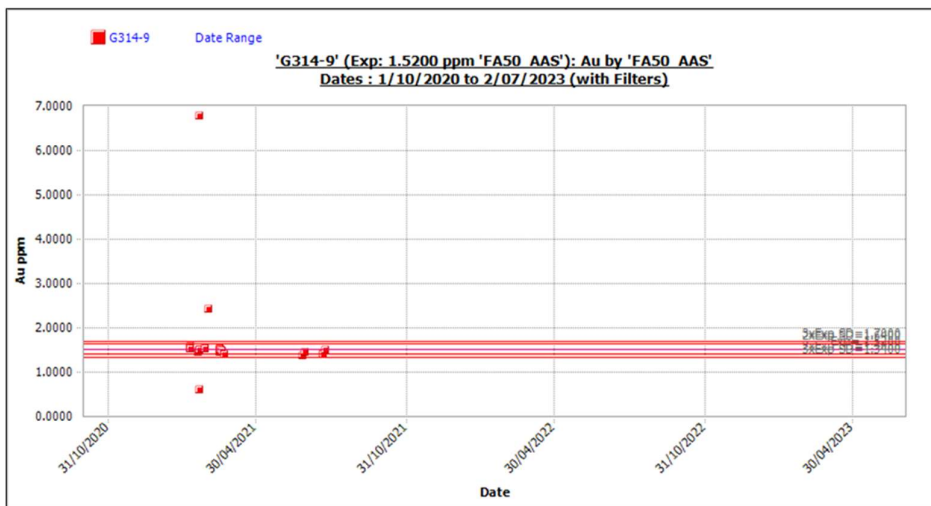

Figure 11-16 Standard G915-6: outliers included

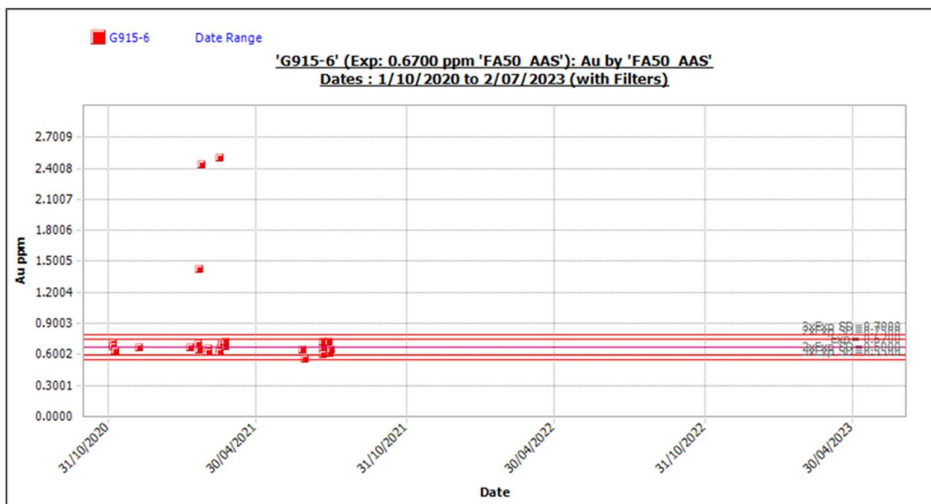

Figure 11-17 Standard G916-6: outliers included

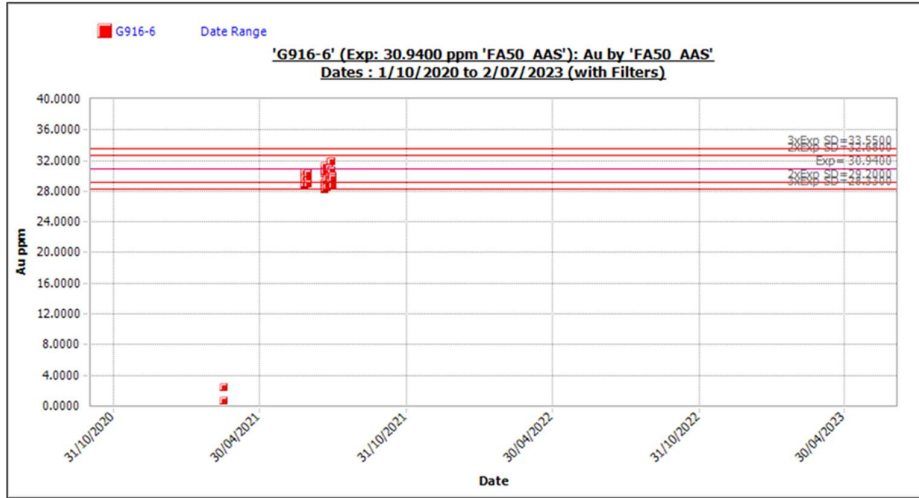

Table 11-9 Karora submitted Au Standards for fire assay ICP-OES ALS Perth and Bureau Veritas Perth, October 1, 2020 to July 2, 2023

Au Standard(s)					No. of Samples	Calculated Values			
Std Code	Method	Exp Method	Exp Value	Exp SD		Mean Au	SD	CV	Mean Bias
G308-2	FA_ICPES	FA_ICPES	1.0700	0.0600	3	1.0767	0.0321	0.0299	0.62%
G313-8	FA_ICPES	FA_ICPES	2.4300	0.1100	9	2.4411	0.0509	0.0208	0.46%
G314-9	FA_ICPES	FA_ICPES	1.5200	0.0600	6	1.4783	0.0407	0.0275	-2.74%
G909-6	FA_ICPES	FA_ICPES	0.5700	0.0300	7	0.5737	0.0415	0.0723	0.65%
G914-2	FA_ICPES	FA_ICPES	2.4800	0.0800	4	2.5350	0.0370	0.0146	2.22%
G914-7	FA_ICPES	FA_ICPES	9.8100	0.3000	1	0.6170	0.0000	0.0000	-93.71%
G915-6	FA_ICPES	FA_ICPES	0.6700	0.0400	1	0.6690	0.0000	0.0000	-0.15%

Figure 11-18 Standard G313-8: outliers included

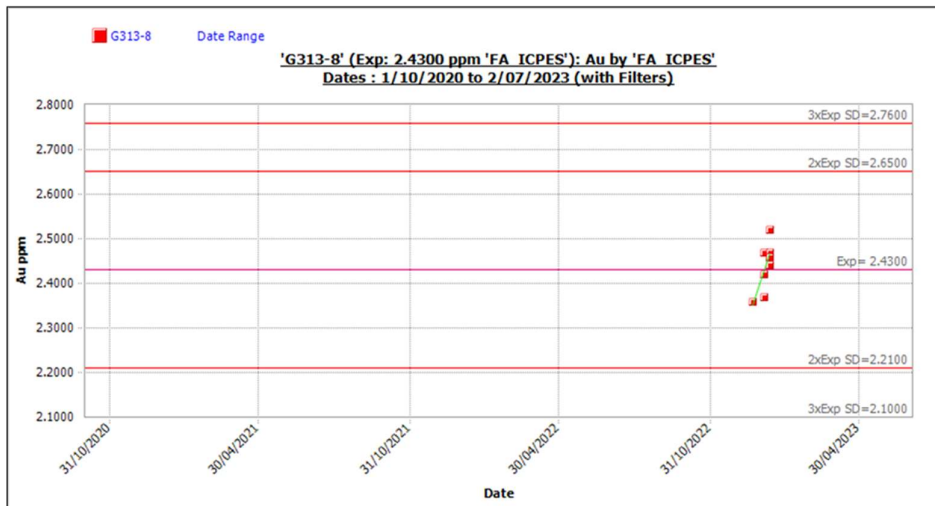

Figure 11-19 Standard G314-9: outliers included

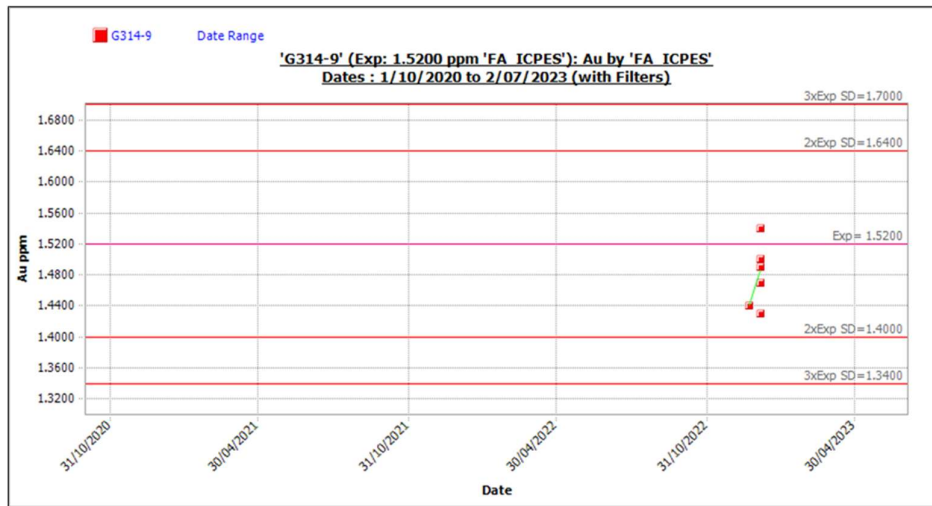

Figure 11-20 Standard G909-6: outliers included

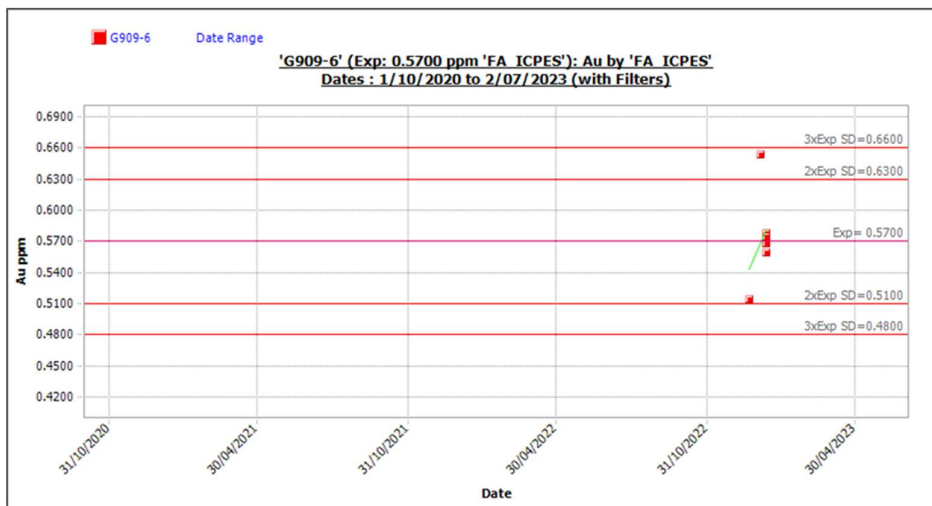

Figure 11-21 Scatter plot comparing field duplicates Au fire assay – log plot

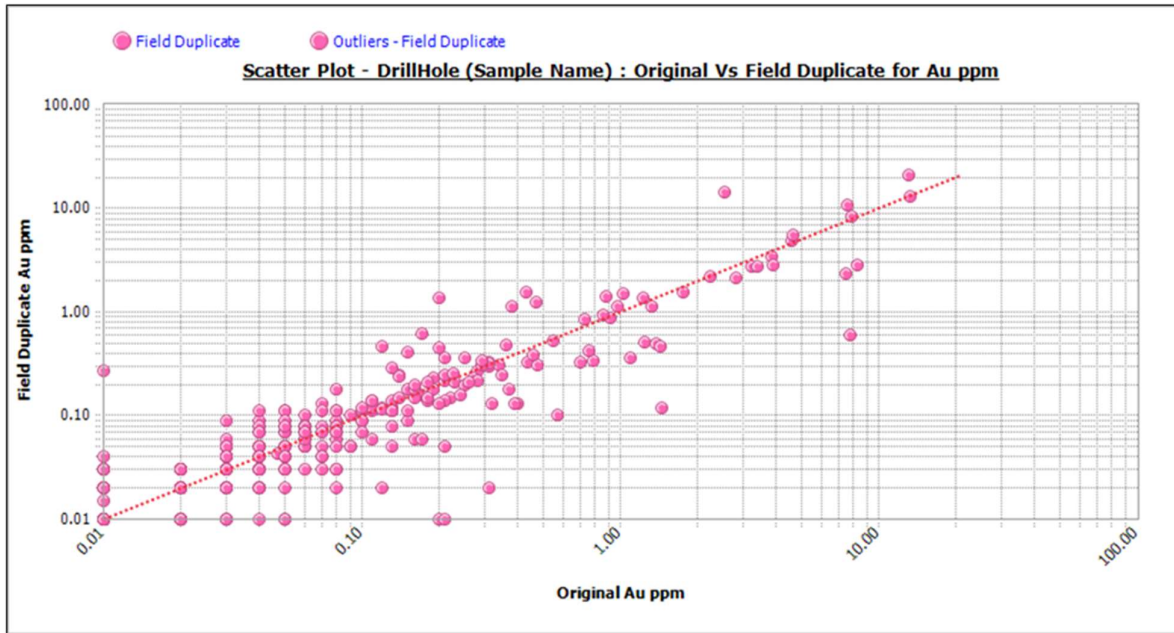
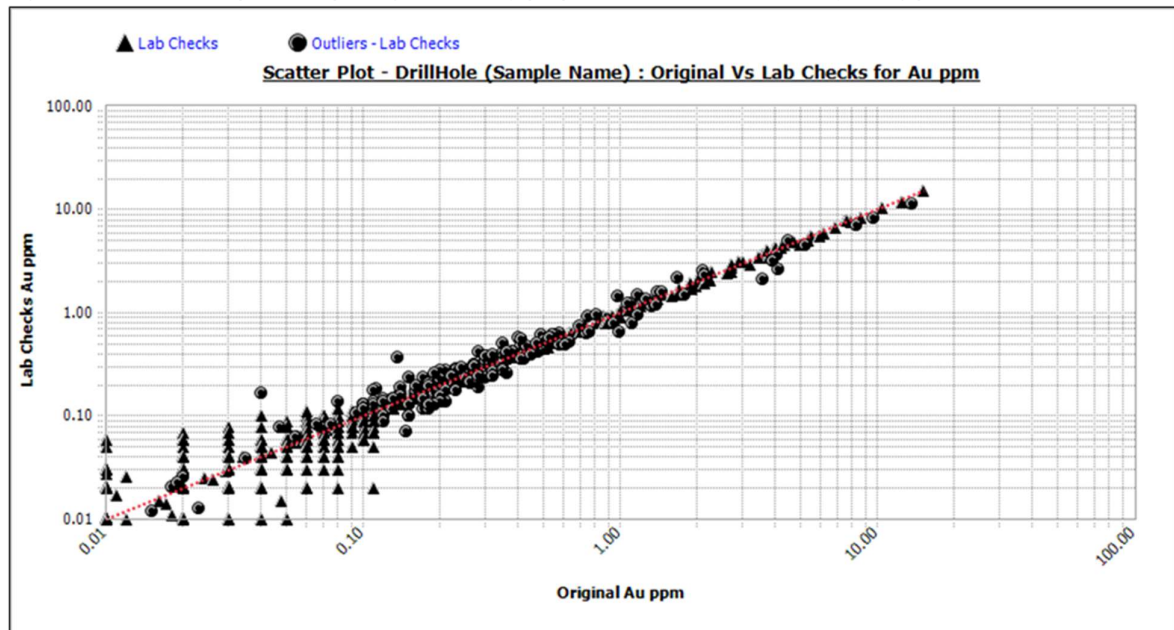

Figure 11-22 Scatter plot comparing laboratory pulp checks for Au fire assay – log plot



11.3.3 Database Integrity

The Karora corporate geological database is located on a dedicated Microsoft SQL 2016 SP4 server. The database itself utilises the Maxwell Geoservices DataShed architecture and is a fully relational system with strong validation, triggers and stored procedures, as well as a normalised system to store analysis data. The database itself is accessed and managed in-house using the DataShed front end, whilst routine data capture and upload is managed using Maxwell's LogChief data capture software. This provides a data entry environment which applies most of the validation rules as they are directly within the master database, ensuring only correct and valid data can be input in the field. Data are synced to the master database directly from this software, and once data have been included, they can no longer be edited or removed by LogChief users except geological logging. Only the Company database manager and authorised senior geologists have permissions allowing for modification or deletion.

In November 2021, the Company upgraded DataShed GDMS. All drilling data were migrated to the latest DataShed Maxwell Data Model (MDM). Data validation checks were performed to ensure data migration integrity, namely drill collars and coordinates, downhole direction surveys, geology, sampling, assays and QA/QC.

11.4 SAMPLE PREPARATION, SECURITY AND ANALYTICAL PROCEDURES SUMMARY

The Qualified Person considers the sample preparation, security and analytical procedures to be adequate. Any data with errors have either been corrected or excluded to ensure data used for Mineral Resource estimation are reliable.

During the site visits, the Qualified Person has inspected the core logging yard and directly observed how core was sampled and transferred to the care of the laboratory. The sampled trays of cut core are stacked on pallets and placed in the onsite core yard. Field inspections of drill sites observing the RC sampling process were also undertaken, specifically at the Pioneer deposit. In the opinion of the Qualified Person, the procedures in place ensure samples remained in the custody of appropriately qualified staff.

A laboratory audit of Bureau Veritas Kalgoorlie was conducted on April 5, 2023 by Karora's Principal Resource Geologist, Senior Resource Geologist, Database Manager, Project Mine Geologist and Project Exploration Geologist. The Qualified Person conducted an audit of the Bureau Veritas Kalgoorlie laboratory on June 17, 2022 and confirmed the processes and equipment met industry standards.

Pulps returned from laboratory sample preparation are stored in the core yard on pallets. These remain available for re-checking of assay programs.

During the site visits, the Qualified Person found no evidence of active tampering. Procedures to prevent inadvertent contamination of assay samples have been followed, including daily hosing out of the core saw and sampling area.

12 DATA VERIFICATION

Through examination of internal Karora documents including monthly QA/QC site reporting, the implementation of routine, control checks and personal inspections on site, the Bureau Veritas Kalgoorlie assay laboratory and discussions with other Karora personnel, the Qualified Person has verified the data in this Technical Report and satisfied himself that the data is adequate for the purpose of this Technical Report.

13 MINERAL PROCESSING AND METALLURGICAL TESTING

The HLO processes its gold mineralization through Karora's Higginsville and Lakewood Mills. Details on gold processing and relevant testwork that relate to the metallurgical performance of the mills are summarized below. Further details on processing are outlined in Section 17.

13.1 GOLD PROCESSING

The current Higginsville Mill has been in operation since July 2008, and local feed variability is well understood. Various testwork programs dating back to 2008 have been used to understand potential impacts during crushing and milling as new production sources come online. As new production sources are delineated, testing is conducted to assess whether the metallurgy will vary significantly from the anticipated responses.

For both the Higginsville and Lakewood Mills, feed characterisation, classification and recovery testwork is conducted on new production sources as required. Typical metallurgical testwork comprises the following:

- Head assays determination;
- Ball mill work index determination and Abrasion index testing;
- Grind establishment to 75 µm;
- Gravity recovery;
- Leach test on the gravity tail with the following set points:
 - pH 8.5;
 - CN at 200 ppm;
 - 40% solids with site water; and
 - 48 hours leach time.

In addition to the above, extended leach testwork is sometimes required using lead nitrate additives. Diagnostic leach testwork may also be carried out if the standard leach test shows lower than expected recoveries.

14 MINERAL RESOURCE ESTIMATES

14.1 SUMMARY

The Mineral Resource Statement presented herein sets out the Gold Mineral Resource estimates prepared in accordance with the Canadian Securities Administrators' National Instrument 43-101 and Form 43-101F.

The Consolidated Gold Mineral Resource estimate for Higginsville (which is divided into two geographical regions, Higginsville Central and Higginsville Greater), is summarised in Table 14-1, and is effective as of September 30, 2023.

Table 14-1 Karora Consolidated Higginsville Gold Mineral Resources as at September 30, 2023

	Measured			Indicated			Measured & Indicated			Inferred		
	kt	g/t	koz	kt	g/t	koz	kt	g/t	koz	kt	g/t	koz
HGO Central												
Mouse Hollow	31	1.0	1	638	1.4	29	669	1.4	30	27	0.9	1
Two Boys	23	1.6	1	1,147	2.3	86	1,170	2.3	87	185	2.8	16
Pioneer	48	1.6	2	574	2.1	38	622	2.0	41	412	1.5	20
Trident	578	4.0	73	717	5.1	117	1,296	4.6	190	1,176	3.1	116
Pluto	-	-	-	-	-	-	-	-	-	119	3.2	12
Mitchell Group	-	-	-	372	2.5	30	372	2.5	30	49	2.8	4
Fairplay	-	-	-	368	2.0	24	368	2.0	24	2	1.0	0
Fairplay North	204	1.3	9	226	1.4	10	430	1.4	19	0	2.5	0
Vine	118	1.3	5	119	1.3	5	237	1.3	10	146	1.8	8
Sub-Total	1,002	2.8	92	4,162	2.5	339	5,164	2.6	431	2,117	2.6	179
HGO Greater												
Atriedies	28	1.7	2	148	2.1	10	176	2.0	11	2	1.7	0.1
Josephine	17	1.6	1	70	2.0	4	87	1.9	5	5	2.2	0.4
Louis	9	1.8	1	481	1.5	23	490	1.5	24	51	1.2	2
Napoleon	5	1.7	0.2	106	1.7	6	110	1.7	6	42	2.0	3
Rose	-	-	-	-	-	-	-	-	-	99	1.2	4
Spargos	-	-	-	615	4.6	92	615	4.6	92	480	3.6	56
Chalice	406	3.2	42	1,120	2.6	94	1,526	2.8	135	655	2.6	56
Wills	-	-	-	70	2.5	6	70	2.5	6	-	-	-
Nanook	-	-	-	-	-	-	-	-	-	625	1.6	31
Musket	99	2.3	7	392	2.2	28	491	2.2	35	290	1.7	16
Mt Henry	11,042	1.2	424	10,172	1.2	378	21,214	1.2	802	2,565	1.3	105.9
Sub-Total	11,607	1.3	476	13,173	1.5	640	24,780	1.4	1,116	4,814	1.8	273
Stockpiles	745	0.6	15	1,135	0.7	27	1,880	0.7	42	-	-	-
Total	13,355	1.4	582	18,469	1.7	1,007	31,824	1.6	1,589	6,931	2.0	452

- 1) Mineral Resources that are not Mineral Reserves do not have demonstrated economic viability. There is no certainty that all or any part of the Mineral Resources estimated will be converted into Mineral Reserves.
- 2) The Measured and Indicated Mineral Resources are inclusive of those Mineral Resources modified to produce Mineral Reserves.
- 3) The Mineral Resource estimates include Inferred Mineral Resources that are normally considered too speculative geologically to have economic considerations applied to them that would enable them to be categorized as Mineral Reserves. There is also no certainty that Inferred Mineral Resources will be converted to Measured and Indicated categories through further drilling, or into Mineral Reserves once economic considerations are applied.

- 4) The Gold Mineral Resources are estimated using a long-term gold price of US\$1,700/oz with a USD:AUD exchange rate of 0.70.
- 5) Gold Mineral Resources were estimated using variable cut-off grades accounting for variable operational costs as follows: Higginsville Underground (Chalice and Trident at 1.3 g/t), (Spargos UG at 1.6g/t); Higginsville Open Pits (excluding Mt Henry Project) 0.5 g/t; and Mt Henry Project 0.4 g/t.
- 6) To best represent 'reasonable prospects of eventual economic extraction', the Mineral Resource for open pits has been reported within an optimised pit shells at A\$2,429/oz (US\$1,700/oz) and, for underground resources, areas considered sterilised by historical mining are removed from the Mineral Resource estimation.
- 7) Mineral Resource tonnage and contained metal have been rounded to reflect the accuracy of the estimate, and numbers may not add due to rounding.
- 8) Mineral Resource Estimates were prepared under the supervision of Qualified Persons S. Devlin (Chief Geological Officer - Karora) and I. Glacken (Geologist & Geostatistician, Snowden Optiro Pty Ltd). Mr. Glacken's responsibility is limited to the Mt Henry Project Mineral Resources.

This section describes the preparation and estimation of Mineral Resources for Higginsville Gold Operations (HGO). The Mineral Resource estimates (excluding the Mt Henry Project Mineral Resources) reported herein were prepared under the supervision of Mr. Stephen Devlin, FAusIMM, in accordance with the Canadian Securities Administrators' National Instrument 43-101 and Form 43-101F. Mr. Devlin is Chief Geological Officer at Karora and has sufficient experience that is relevant to the style of mineralisation and type of deposit under consideration and to the activity being undertaken to qualify as a Competent Person as defined in the JORC Code, 2012 Edition and fulfils the requirements to be a 'Qualified Person' for the purposes of NI 43-101.

There are no material differences between the definitions of Mineral Resources under the applicable definitions adopted by the Canadian Institute of Mining, Metallurgy and Petroleum (the CIM Definition Standards) and the corresponding equivalent definitions in the JORC Code for Mineral Resources.

In the opinion of Mr. Devlin, the Mineral Resource estimation reported herein (excluding the Mt Henry Project Mineral Resources) is a reasonable representation of the consolidated gold Mineral Resources found at HGO at the current level of sampling.

The Mt Henry Project Mineral Resources (part of the Higginsville Greater area) have not been updated since the NI 43-101 Technical Document dated January 29, 2021 (Karora, 2021a) was filed on SEDAR February 2021. However, the deposits have been reported within revised optimised pit shells. Mr. Ian Glacken, FAusIMM(CP), FAIG, MIMMM, is the Qualified Person for these Mineral Resources. The Mineral Resources have been prepared and reported in accordance with the CIM Definition Standards (CIM, 2014). Mr. Glacken is a full-time employee of Snowden Optiro Pty Ltd and a QP as defined by NI 43-101 guidelines.

In the opinion of Mr. Glacken, the Mineral Resource estimation at the Mt Henry Project (which forms part of the Higginsville Greater area) reported herein is a reasonable representation of the consolidated gold Mineral Resources found at the Mt Henry Project at the current level of sampling.

Mineral Resource estimates, including the historical (Westgold) Mineral Resources at HGO, were previously reported by Karora in a Technical Report dated January 29, 2021 as filed on SEDAR. The Mineral Resource estimates reported in this section supersede those previously reported. The changes to the previous Mineral Resource are a result of the following:

- Additional exploration data;
- Revised technical understanding;
- Depletion for mining; and
- Changed economic thresholds impacting reasonable prospects for eventual economic extraction (RPEEE).

14.2 HIGGINSVILLE GOLD OPERATIONS

HGO is geographically divided into two areas as shown in Figure 14-1. The subdivision was established to assist with distinguishing those Mineral Resources proximal to existing Karora infrastructure (i.e. Higginsville Central) and those ‘satellite’ Mineral Resources (i.e. Higginsville Greater).

Figure 14-1 Location of Karora Mineral Resources and Mineral Reserves effective September 30, 2023. Plan also depicts Higginsville Central and Higginsville Greater

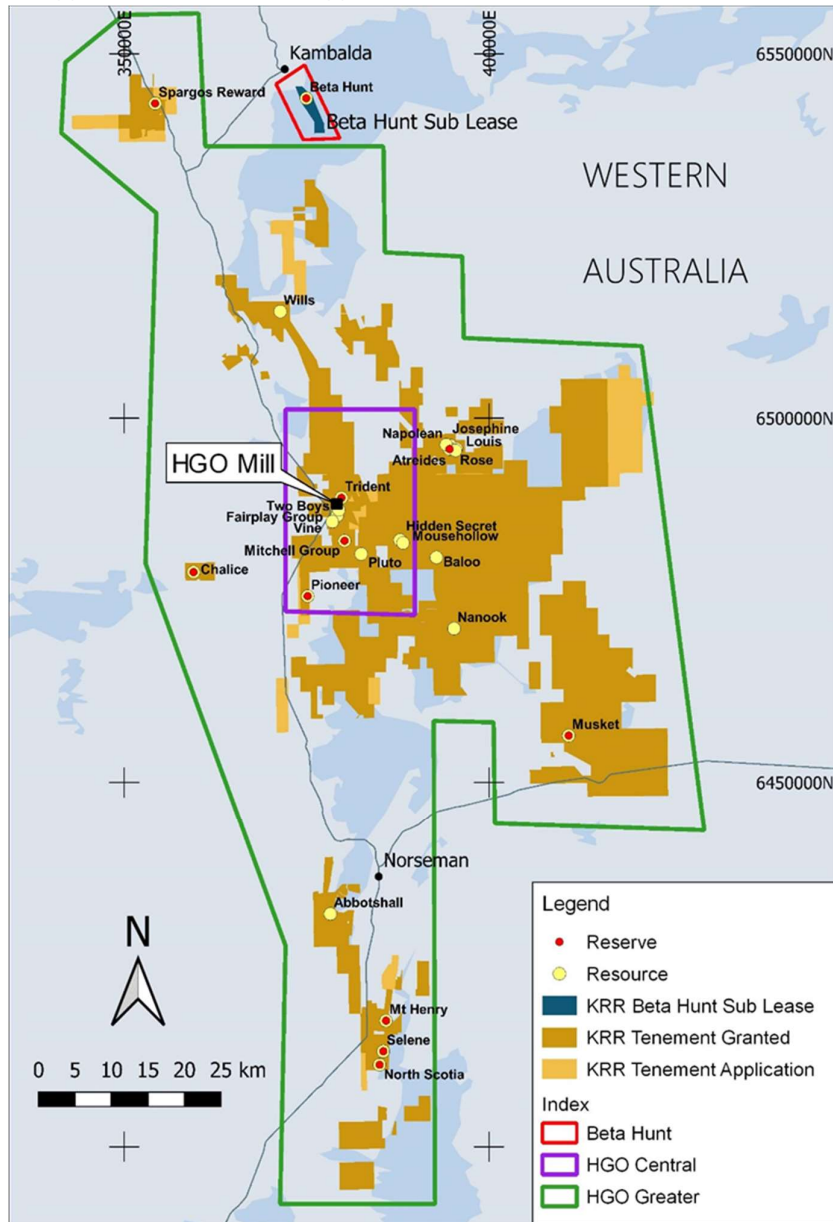

14.3 HIGGINSVILLE CENTRAL

Higginsville Central consists of deposits located within approximately 10 km of the Higginsville Mill and includes the Trident underground deposit, open pit deposits of Eundynie Group (Hidden Secret and Mouse Hollow), Two Boys, the Fairplay-Vine group (Fairplay North, Fairplay Main, Vine), Pioneer, and the Palaeochannel deposits (Challenge, Mitchell, Graveyard, and Aphrodite). A location plan is shown in Figure 14-2.

Figure 14-2 Location of deposits of the HGO Central Mineral Resources

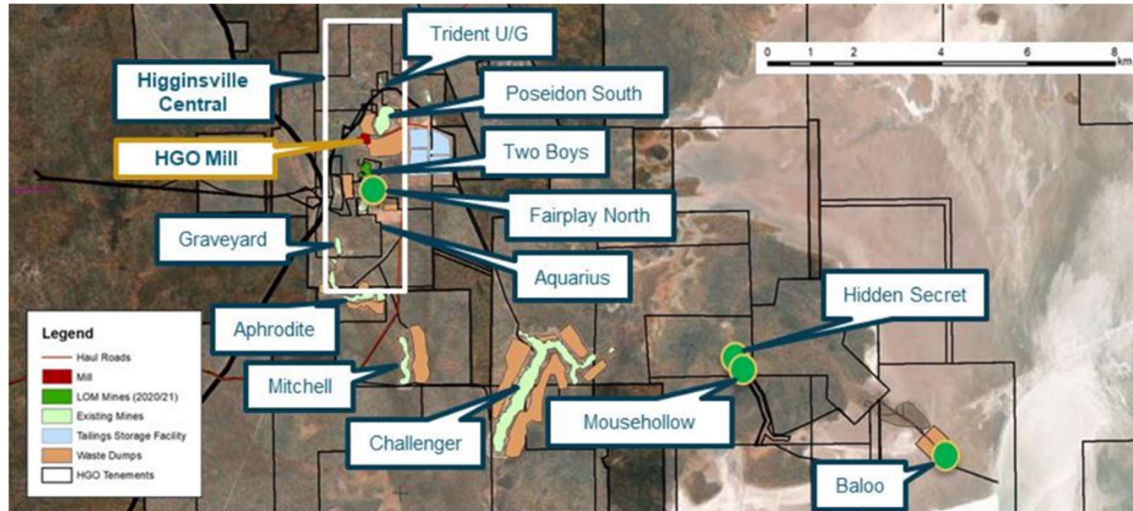

The Higginsville Central deposits were last reported in the Technical Report dated January 29, 2021 as filed on SEDAR. Since that report, the current status of the HGO Central Mineral Resources is summarised as follows:

- Trident, Fairplay, Vine, Pluto and Mitchell Paleochannel deposits Mineral Resource estimates remain unchanged from the Technical Report dated January 2021 (refer www.sedar.com). These deposits have been reported in revised pit shells for the 2023 Technical Report.
- The Hidden Secret deposit was mined by open pit methods and the resource completely depleted.
- Pioneer, Two Boys and Mouse Hollow deposits - additional drilling programs and mining activities have resulted in updated Mineral Resource models which are detailed in this Technical Report.

All HGO open pit deposits were previously reported within optimised pit shells. These have been updated to September 2023 to reflect changing economic parameters. The Higginsville Central deposits are reported within the revised pit shells.

14.3.1 Trident

14.3.1.1 Summary

The Trident deposit is located approximately 1 km north of the Higginsville Mill and is part of the Line-of-Lode, a series of deposits along a roughly north-south trend with the Trident deposit the most northerly (Figure 14-3). The Line-of-Lode trend is bounded by the Poseidon Thrust to the east and Thrust A to the west.

Figure 14-3 Trident location map

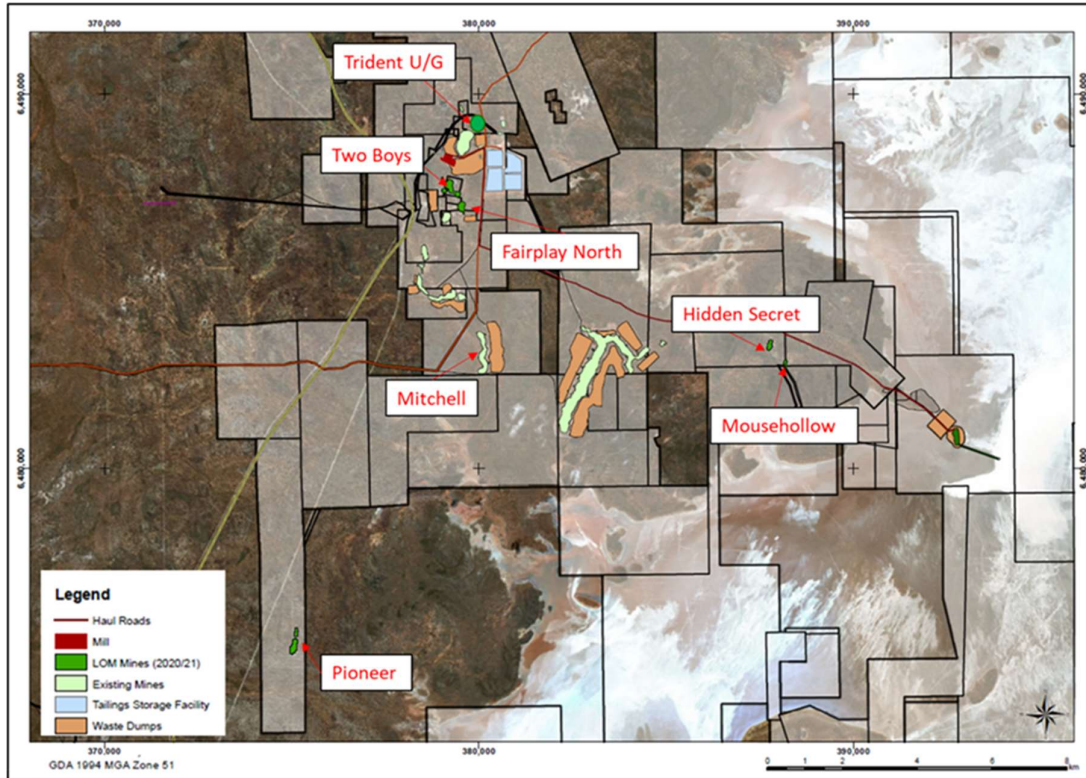

The Trident underground (UG) mine is accessed via the Poseidon open pit (currently inactive). Historical production from the open pit and underground was 600,000 oz of gold from 1989 to 1999.

Trident underground provided the backbone of production for the Higginsville Mill from 2007 to 2016, producing 1.15 Moz from 9.1 Mt at an average grade of 4.06 g/t Au from 2007–2016 (Sieradzki, 2017). The Trident UG mine commenced operations in early 2007 and ceased operations in December 2016. Initial mining commenced via rehabilitation of an historic decline (Poseidon Underground) and then via the establishment of two declines (Trident and Athena) to access the Western Zone (WZ) and Athena Lodes. The existing Trident decline extends from the portal (within the completed Poseidon Open Pit) at 1,185 mRL to 280 mRL (1,020 m depth) whilst the Athena decline levels out at the 934 level (251 m depth).

A final Mineral Resource report was completed by Westgold in 2017 which summarised the current block model for the Trident deposit (Trident_res_mar17.bmf). The model was created in Vulcan software and used as the operational model during underground mining of the deposit. A review of this model was completed by Karora in July 2021.

Host rock-types comprise fault-bounded, thrust repeated north-northwest trending mafic-ultramafic and sedimentary packages up to 5 km in width (McEwan, 2001). The mafic-ultramafic rocks comprise upper greenschist to middle amphibolite facies metamorphosed high magnesium basalt, minor komatiite units and interflow clastic sedimentary rocks intruded by dolerite and gabbro. The sedimentary rocks to the east comprise felsic metasedimentary, felsic volcanoclastic rocks and carbonaceous shales (Buerger et al., 2010).

14.3.1.2 Drilling and Sample Data

Westgold stored the Trident drill hole data in a Vulcan Isis database last date stamped for modelling on January 3, 2017. The CSV files exported and stored with the statistical work were dated March 5, 2017.

The data contained within mineralisation models and used in the resource estimation process is sourced 97.1% from diamond drill holes, 2.4% from face channel sampling with the remaining 0.5% from RC drill holes.

Assay methods were prioritised. If a sample was assayed by several methods, the priority order was Leachwell (1 kg and 400 g), PAL and fire assay.

Face data were only used for Artemis and Helios 456, 434 and 412 levels, where the interpretation was snapped to face sampling. All other face data were excluded. All sludge, rotary airblast (RAB) and aircore holes were excluded.

A small number of holes were excluded from the drill hole data in the model. One hole had been drilled through Athena 30 area, mined later, and the face grades were much higher than the drill hole. Four holes in Athena 10 with high grades were deemed to be inaccurately located. Four holes in the Western Zone were subparallel to the lodes and unrepresentative, and three holes removed because positional discrepancies indicated that face data would be more accurate.

Karora has drilled a total of 99 holes since 2020 which include two diamond holes, 84 RC holes (73 grade control (GC) holes), and 12 RC holes with diamond tails. Most of the RC holes were drilled in the south of the existing Poseidon open pit, whilst diamond holes were drilled west of the Trident lodes testing for mineralisation repeats.

14.3.1.3 Modelling Domains

The domain areas defined during mining of Trident were based on the dominant style of mineralisation and the relative spatial distribution of each. In total, 11 mineralised domains were identified: Western Zone, Apollo, Athena, Eos, E-Veins, Eastern Zone (EZ), Poseidon, Ares, Pluto, Artemis and Helios (Figure 14-4). These domains comprise numerous individual lodes.

The mineralisation can be split into two main styles: large zones of sigmoidal quartz tensional vein arrays of various attitudes and associated metasomatic (primarily silica-albite) wall rock alteration (Western Zone, Eastern Zone, Ares, Pluto, and Apollo) hosted exclusively within the gabbro; and lode style, thin laminated quartz veins (Athena and Artemis) that formed primarily at sheared lithological contacts between the various mafic and ultramafic lithologies.

The wall rock hosted lodes are primarily located within steep east dipping shear zones and hosted within the Poseidon Gabbro.

Figure 14-4 Trident domains – long-section looking west

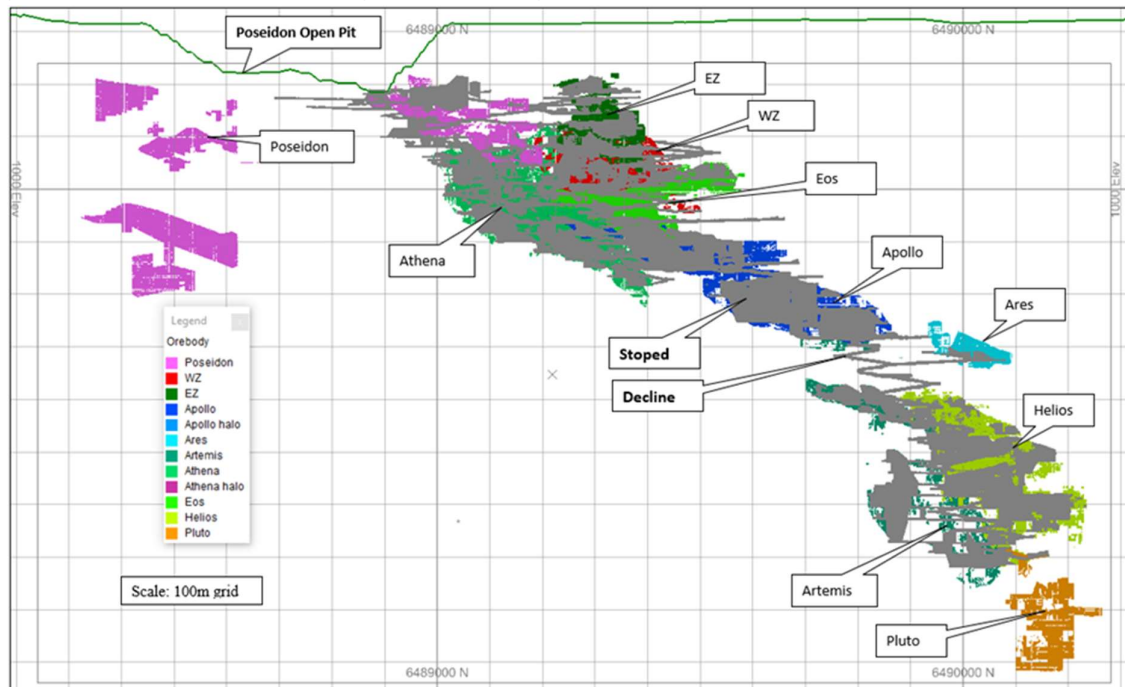

Digitised wireframes were completed in Vulcan software by snapping to drill data. Core photos were utilised to correlate grade boundaries with veining and visual alteration and mineralisation. The interpretation methodology varied depending on the mineralisation style. In the larger, wall rock-hosted lodes (WZ, Poseidon, EZ, Apollo North and South, Eos and E-Veins, Helios), mineralisation boundaries were generally delineated visually using mapping drafted on to sections with the aid of diamond drill core photos. For consistency, where a visible control was not clear, but elevated grade was evident, a nominal cut-off grade of 0.8 g/t Au was applied to the interpretation. Conversely, in places (particularly in Apollo), zones of visible mineralisation and alteration were included in the interpretation.

In the narrow vein-style mineralisation, lode boundaries were delineated by the margins of the massive and laminated quartz veins. Where auriferous laminated quartz veining was in contact with barren bucky quartz, the margin of the laminated quartz was the lode boundary with the bucky quartz excluded. Due to the nuggety nature of the laminated quartz, where apparently barren zones of laminated quartz were seen, these were interpreted as being auriferous and included in the interpretation. Once narrow vein lodes (AT10, structurally controlled AT30, AT50 and Artemis) had been developed, the interpretation was adjusted to match the surveyed lode outlines as marked up by the production geologist.

The Trident mineralised lodes are shown in Figure 14-5.

Figure 14-5 Trident lodes – long-section looking west

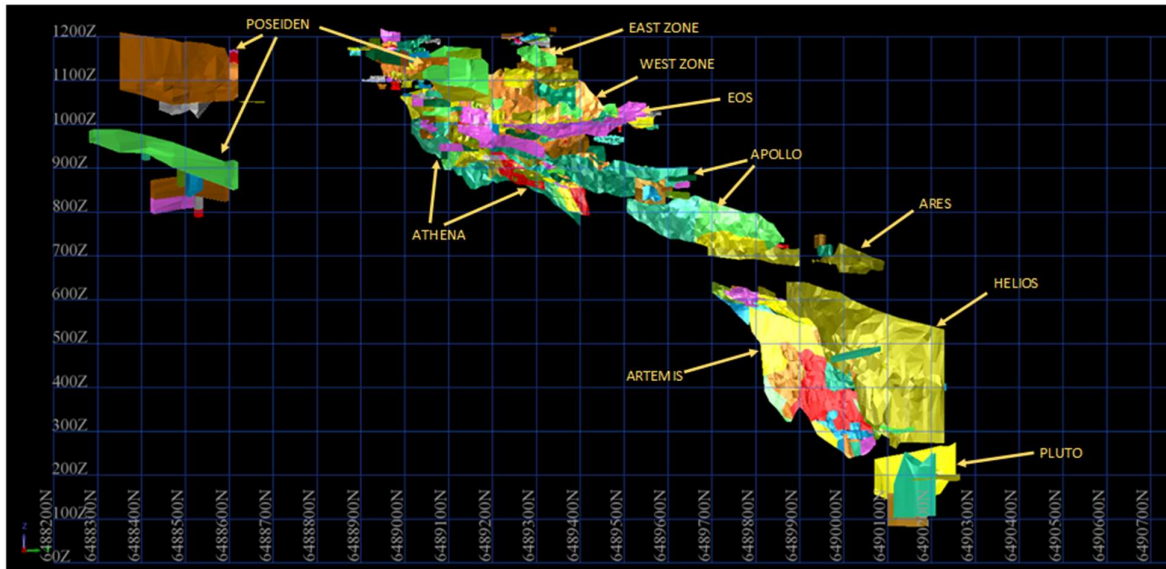

14.3.1.4 Statistical Analysis and Compositing

Downhole composites were extracted within the different resource domains. Holes were composited to 1 m. Westgold noted that the Athena and Artemis lodes were narrow (and in many cases less than a metre wide), and that 32% of the generated composites were less than or equal to 0.5 m. These residuals were retained, and the Vulcan length weighting function used in the estimation. Domains of similar orientation, geology and statistics were grouped for variogram modelling, statistical analysis and estimation purposes.

In other areas, geologically consistent domains were sub-domained where there were changes in the orientation or magnitude of the mineralisation. This was to ensure each domain represented a single grade population of a consistent orientation. An example would be where a lode changes dip and was split into two sub-domains, one steep and the other shallower, allowing a separate search to be employed in each. Similarly, high-grade shoots or zones of internal waste were sub-domained to keep different populations separate and prevent smearing grade into unwanted areas. To achieve this, the global mineralisation wireframes were split, creating a new wireframe for each sub-domain. The Artemis lodes are shown in Figure 14-6.

Figure 14-6 Artemis main wireframe (top) and sub-domaining (bottom) – long-section view looking west

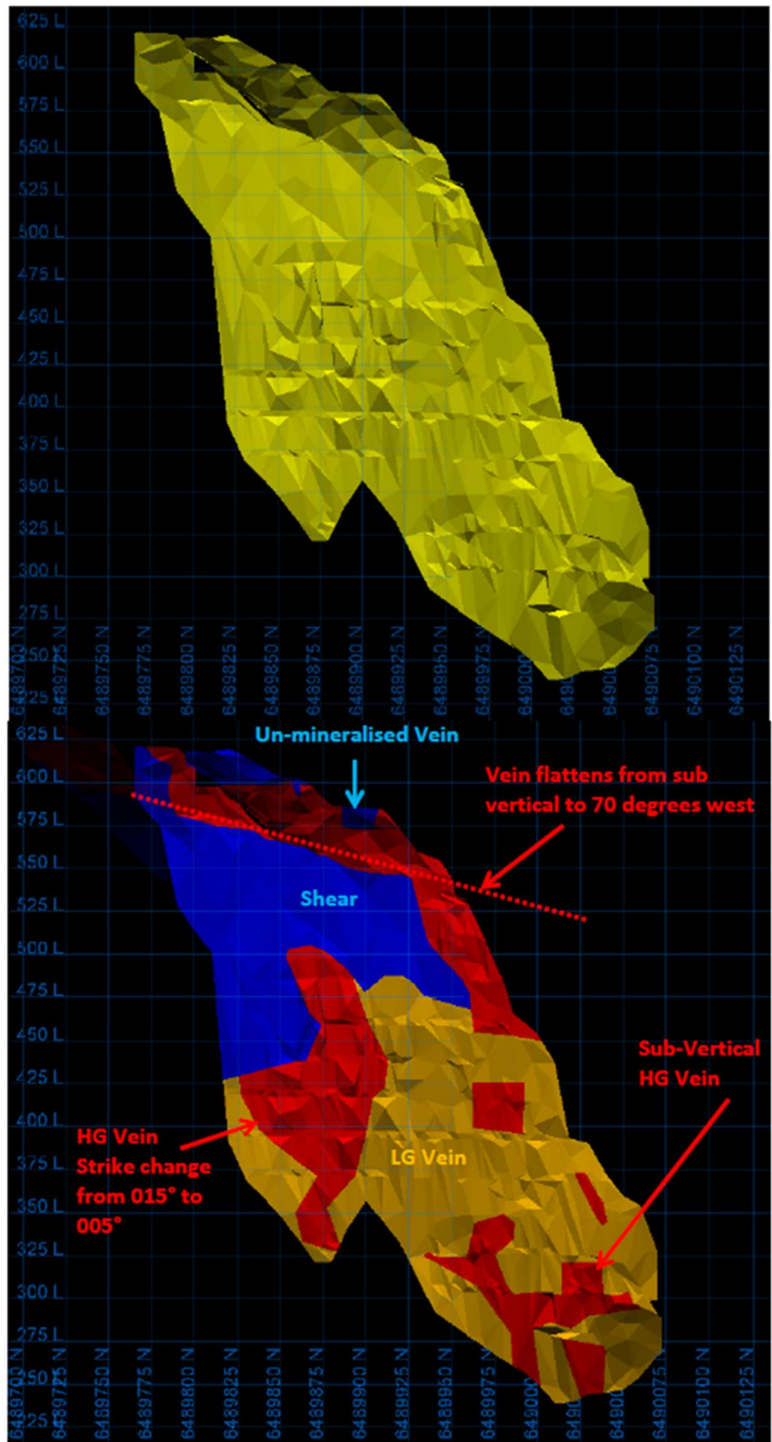

Top-cuts were applied across all domains (Table 14-2). The values are based on inspection of the cumulative frequency curve, and the mean and variance plot for the upper point at which the trend line breaks down and reflects the different mineralisation types.

Table 14-2 Top-cuts applied to each domain

Zone	Au g/t
Poseidon	50
Eastern Zone	50
Athena 10	250
Athena 30	350
Athena 40	250
Athena 50	90
Athena 51/52	70
Western Zone	50
EOS + E-veins	50
Apollo Sth	50
Apollo Nth Sub 1	70
Apollo Nth Sub 2	40
Apollo Nth Sub 3	50
Artemis Steep	250
Artemis Helios Join	140
Artemis FW	210
Artemis East	200
Artemis FW Shear	100
Helios Shear	10
Helios Core 1,2 & 3	30
Helios HW Quartz	240
Helios E Shear	40
Ares	14
Pluto	28

14.3.1.5 Density

A bulk density of 2.89 t/m³ was applied to most lodes and the surrounding waste blocks, whilst a bulk density of 2.65 t/m³ was applied to the laminated quartz lodes of Athena 10, Athena 30 and Artemis. The bulk densities were based on a combination of testwork completed for the 2006 Feasibility Study (203 samples from all rock types) and an additional 250 samples analysed in February 2010 which confirmed that a bulk density of 2.89 t/m³ was robust for use throughout the Trident deposit, except for the quartz-dominated lode-style mineralised systems where a 2.65 t/m³ bulk density was applied. For both tests, samples were selected to cover the full range of lithology type from a geometrically dispersed range across the deposit. Individual unbroken half core samples of approximately 30 cm length were randomly selected from within specified metre intervals. Samples were sent to Genalysis Laboratory in Kalgoorlie, where mass and volumes (by water immersion) were measured, and bulk density calculated. Density values assigned to the model are shown in Table 14-3.

Table 14-3 Bulk density summary of test results by rock type and area

Lithology	Bulk Density (g/cm ³)
Gabbro	2.89
Apollo	2.89
Western Zone	2.88
Eastern Zone	2.89
Ultramafic	2.93
Quartz Lodes	2.65

14.3.1.6 Variography

Variograms were analysed in Snowden Supervisor software. Normal scores transforms were applied to limit the influence of extreme grades. Composites within lodes that exhibited common style, geology and univariate statistics were grouped for variogram modelling.

A summary of variogram groupings and resulting parameters is shown in Table 14-4.

Table 14-4 Trident variogram orientations and model parameters

Orebody	Lode	Domains		Directions	C0	Structure 1			Structure 2		Structure 3		Rotation
		Used for Analysis	Analysis Applied To			C1	A1	C2	A2	C3	A3		
Apollo	Apollo South	6100	6100	Dir 1	0.29	0.37	2	0.2	13.5	0.14	169.5	X	197
				Dir 2			2.5		31		66	Y	13
				Dir 3			0.5		3		22	Z	121
	Apollo North	6201	6201	Dir 1	0.52	0.33	10	0.15	52			X	185
				Dir 2			3		9.5			Y	4
				Dir 3			3		8.5			Z	120
		6202	6202	Dir 1	0.24	0.5	4.5	0.26	32			X	188
				Dir 2			24.5		25			Y	5
				Dir 3			10.5		11			Z	110
	6203	6203	Dir 1	0.26	0.42	13.5	0.15	27.5	0.17	36	X	191	
			Dir 2			3		21.5		48	Y	3	
			Dir 3			9.5		12.5		13	Z	140	
Artemis	Artemis & Artemis/Helios Join	7103	7103 7102	0.15	0.85	Dir 1		28				X	65
			7104 7110			Dir 2		10				Y	90
			7112 7115			Dir 3		4				Z	195
	Artemis Upper	7106	7106 7105 7101	Dir 1	0.27	0.73	50					X	117.2
				Dir 2			42.5					Y	22.5
				Dir 3			3					Z	183.9
	Artemis South	7107	7107 7108 7109	Dir 1	0.34	0.66	30					X	112.8
				Dir 2			13					Y	28
				Dir 3			3.5					Z	178.8
	Artemis HG South shoot	7113	7113 7117	Dir 1	0	0.69	14	0.31	41			X	75
				Dir 2			6		17			Y	-90
				Dir 3			2.5		3.2			Z	5
	Artemis Main Lower	7114	7114 7116	Dir 1	0.46	0.54	29					X	30
				Dir 2			19					Y	90
				Dir 3			5					Z	195
	Artemis FW	7201	7201 7203 7204	Dir 1	0.4	0.6	53					X	140.7
				Dir 2			41					Y	23.9
				Dir 3			9.5					Z	173.7
Artemis FW	7202	7202	Dir 1	0.17	0.51	26.5	0.31	42			X	90	
			Dir 2			6.5		7			Y	15	
			Dir 3			3		14			Z	180	
Artemis East	7301	7301	Dir 1	0.2	0.3	9	0.5	31			X	12.3	
			Dir 2			26.5		27			Y	38.4	
			Dir 3			3		3.5			Z	220.7	
Helios	Helios Shear & Helios Core's	8102	8102 8100	0.38	0.18	Dir 1	0.44	25.5		26		X	129
			Dir 2			25.5		26			Y	24.2	
			Dir 3			3		9			Z	166.7	
	Helios HW Qtz	8103 8104 8105	8101 8103 8104 8105 8106 8109 8111 8112 8113	Dir 1	0.31	0.32	11	0.37	28			X	90
				Dir 2			2		10			Y	0
				Dir 3			1		5.5			Z	180
		8201	8201	Dir 1	0.43	0.34	29	0.23	29.5			X	-120.9
				Dir 2			4		26			Y	12.9
				Dir 3			1.5		26			Z	7.6
	8202	8202 8108	Dir 1	0.2	0.36	27	0.44	250			X	95	
			Dir 2			54		55			Y	0	
			Dir 3			6		7			Z	195	
Helios E Shear	Indicative	8301	Dir 1	0.43	0.57	30					X	4	
			Dir 2			30					Y	14.5	
			Dir 3			10					Z	289.5	
Ares	Ares	9102	9102 9101 9103 9014	0.11	0.54	Dir 1	0.35	27			X	11.4	
			Dir 2			4		6			Y	131	
			Dir 3			2.5		3			Z	175.2	
Pluto	Pluto, Pluto FW & Pluto upper	10100	10100 10101 10103 10104	0.38	0.54	Dir 1	0.09	42		49		X	15
			Dir 2			24		49			Y	90	
			Dir 3			5		10			Z	185	
	Pluto East, Pluto Upper East	Indicative	10102 10105	Dir 1	0.31	0.69	20					X	0
				Dir 2			10					Y	25
				Dir 3			10					Z	180

14.3.1.7 Block Model and Grade Estimation

Details of the Vulcan block model extents are shown in Table 14-5 and have been reproduced from Westgold (Sieradzki, 2017).

Table 14-5 Trident block model extents – Westgold Vulcan Model March 2017

Scheme	Start X Offset	End X Offset	Start Y Offset	End Y Offset	Start Z Offset	End Z Offset
parent	379400.0	6488240.0	60.0	380160.0	6490280.0	1240.0
sub_at	379600.0	6488960.0	760.0	380020.0	6489400.0	1240.0
sub_ap	379700.0	6489400.0	60.0	380160.0	6490280.0	1120.0
sub_wz	379720.0	6489180.0	800.0	380020.0	6489600.0	1240.0
sub_pos	379400.0	6488240.0	1060.0	380160.0	6488960.0	1240.0
sub_pos_sth	379400.0	6488240.0	760.0	379960.0	6488700.0	1080.0

The Trident block model is large and has been modelled as a set of sub-models which were added back to the main model.

The parent block size was set to 20 mX x 20 mY x 20 mZ with variable sub-blocking ranging from 10 m to 0.25 m dependent on lode.

Four estimation methods were summarised by Westgold. A grade assignment method was applied to the Athena lodes using the development mapping and sampling to assign a grade for the lode between two development levels. The remainder of the lodes were estimated using inverse distance (ID) to various powers or through ordinary kriging (OK).

The ID⁰ method was applied for all Athena lodes due to the nuggetty distribution of gold within these lodes which means that samples in close proximity to the estimated block have no greater correlation to the block grades than do samples at a greater distance. Hence, a rolling average estimation technique was applied. This is augmented by extensive sub-domaining where high grade shoots are domained and estimated separately and prevents any unwanted smearing of high grades which can be a problem when using ID⁰ to estimate.

The ID² method was applied to Western Zone, Eastern Zone and Poseidon. The application of this method assumes that the degree of correlation between sample points increases with their proximity to each other; hence, a weighting for the inverse distance method was applied.

Ordinary kriging was applied to Apollo South, Apollo North, Artemis, Helios, Ares and Pluto.

A grade assignment methodology has been used to assign grades to blocks in developed or partially developed areas for the narrow lode-type Athena domains; these being AT30 where it is structurally controlled by the CP Fault, AT50 and AT10.

Estimation search parameters were based on modelled variogram ranges. Where inverse distance interpolation was used, search ellipses were derived for each domain based on the interpreted orientation of the mineralisation. The range of search was set to roughly three times the drill spacing of each domain.

In domains where the kriging system was applied, the orientation and range of the search ellipses were determined using modelled variogram parameters (guided by an understanding of the geological continuity).

The minimum number of samples varied between 1 and 10, and the maximum between 8 and 30 composites for the ID⁰ and ID² grade interpolations. Where ordinary kriging was used, the

typical minimum number of samples was eight for the first two passes and 10 for Pass 3. The typical maximum number of samples used for estimation was 30. Discretisation was set to a default of 4, 4, 4 (X,Y,Z).

Octant searches were applied to nine domains with closely spaced drilling to minimise the impact of clustering. Maximum samples per octant was set to 10, minimum number of octants with samples set at three, and minimum samples per octant of one. The domains were estimated by ID² interpolation.

For the majority of blocks, a total of three interpolation passes were completed, which generally filled 100% of the blocks within each specified domain. There were four Poseidon domains (1109, 1110, 1201 and 1202) that failed to fill on three passes, and a fourth estimation pass was required to estimate all blocks within these domains.

Within the block model, the attribute 'orebody' describes the abbreviated name of each lode area, whilst each individual lode is assigned a numerical code. The remnant material is coded as mined = 0 (in situ material). The block model showing the in situ material (>1.3 g/t Au) remaining at the deposit is displayed in Figure 14-7. Only blocks that are classified as Measured, Indicated or Inferred are displayed.

Figure 14-7 Trident model in situ blocks >1.3 g/t Au – long-section looking west

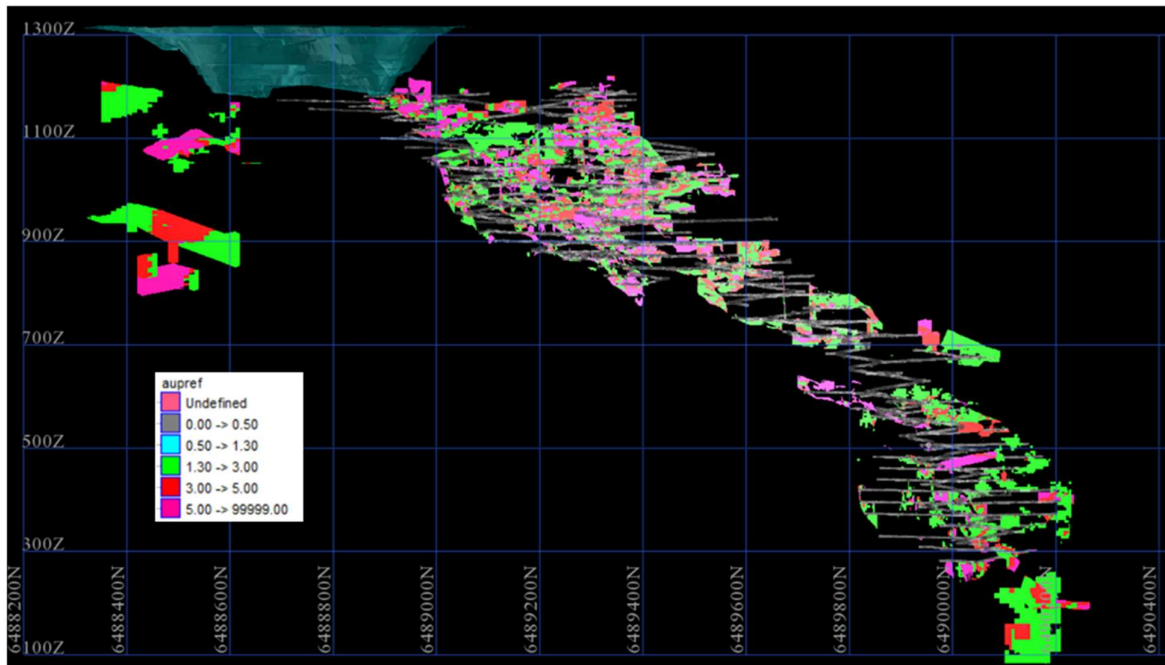

14.3.1.8 Model Validation

Global comparisons of grade estimates versus input composites were completed by statistical analysis and visual comparisons. The block volume of each domain was also compared to the corresponding wireframe volume to ensure the sub size chosen allowed for accurate representation of the mineralisation volumes.

Sectional and elevation trend swath plots were generated for each lode. The profiles compared the volume-weighted average of the block grades to the length-weighted mean of the input composite grades for northing, easting and elevation slices through the block model. The plots

assist in the assessment of the reproduction of local mean grades and are used to validate grade trends in the model.

The model was also validated by reconciling production data. Reconciliation figures were summarised by Westgold (Sieradski, 2017) against production from January 1, 2016 through to December 31, 2016.

The reconciliation shows a comparison between the designed tonnes and grade, recorded by running the designed stope volumes through the block model, and the actual reconciled tonnes and grade mined for each orebody during 2016. The data shows that 16% more tonnes were extracted from stopes mined in 2016 than were expected. The extra material was considered as overbreak from the hangingwall and footwall of stopes and was generally un-mineralised. The reconciled grade of 3.8 g/t Au was 13% lower than the model estimate; however, the extra tonnes mined resulted in 1% more total ounces being produced. The assumption was that for the areas mined during 2016, the model was slightly overestimating the grade and underestimating the contained metal.

The reconciliation data were used to validate the models' performance in areas where the grade is 'known', such as areas that have been mined and reconciled against processing figures (Table 14-6). Westgold concluded that the model accurately reflected the grade of material mined in 2016, which provided confirmation that the grade estimation method was appropriate.

Table 14-6 Reconciliation data for CY 2016

	Production Data 2015								
	Stope Design			Actual			% difference		
	Tonnes	Grade (g/t)	Oz	Tonnes	Grade (g/t)	Oz	Tonnes	Grade (g/t)	Oz
Pos	79,167	3.8	9,705	76,267	3.2	7,753	-4%	-17%	-20%
Pluto	3,054	4.4	432	5,422	1.6	277	78%	-64%	-36%
Apollo	10,060	3.2	1,021	12,526	2.2	881	25%	-31%	-14%
Athena	13,421	4.1	1,778	18,132	5.2	3,033	35%	26%	71%
EZ	7,646	3.1	763	8,283	4.2	1,113	8%	35%	46%
Artemis	48,998	6.5	10,285	59,472	4.9	9,307	21%	-25%	-10%
Ares	5,610	3.1	551	5,781	3.7	688	3%	21%	25%
Helios	285,798	4.2	38,594	341,809	3.7	40,610	20%	-12%	5%
Total	453,754	4.3	63,129	527,692	3.8	63,662	16%	-13%	1%

14.3.1.9 Mineral Resource Classification

The Mineral Resource classifications for each domain, or part thereof, were assigned with consideration for the confidence in the tonnage/grade estimations, reliability of input data, confidence in continuity of geology and metal values, quality, quantity and distribution of the data, using the guidelines listed in Table 1 of the JORC Code. The Trident Mineral Resource was classified in the model on the following basis:

- 1) The Measured category was applied between completed development horizons and where the data were sufficiently detailed.
- 2) The Indicated Mineral Resource was assigned to all material within the defined drilled-out portion of the resource.
- 3) The Inferred Mineral Resource was assigned where the data density was sufficient to imply, but too sparse to verify, geological and grade continuity.

The Trident Mineral Resource was classified in accordance with the JORC Code 2012 guidelines. A reconciliation of this reporting and the CIM Definition Standards (2014) by the Qualified Person shows no material differences.

The block model coloured by Mineral Resource classification is shown in Figure 14-8.

Figure 14-8 Trident block model coloured by resource classification – long-section looking west

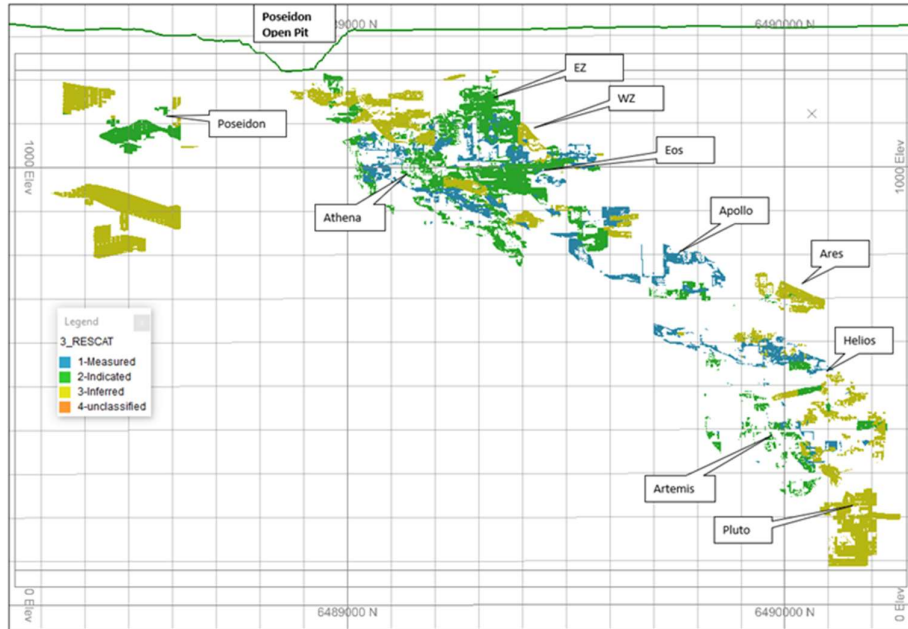

14.3.1.10 Mineral Resource Statement

The Mineral Resource Statement presented herein sets out the Gold Mineral Resource estimate prepared in accordance with the Canadian Securities Administrators' National Instrument 43-101 and Form 43-101F.

The 'reasonable prospects for eventual economic extraction' requirement generally implies that the quantity and grade estimates meet certain economic thresholds and that the mineral resources are reported at an appropriate cut-off grade that takes into account extraction scenarios and processing recoveries. At Trident, areas considered sterilised by historical mining activities were removed from the Mineral Resource estimation. These areas were adjacent to mined out stopes as 'skins' of material on stope voids or as pillars between stopes. During 2020, Karora digitised sterilisation shapes around these locations (shown in Figure 14-9). The remaining blocks represent the current in situ Mineral Resource.

Figure 14-9 Karora sterilisation shapes shown in cyan colour – longsection looking west.

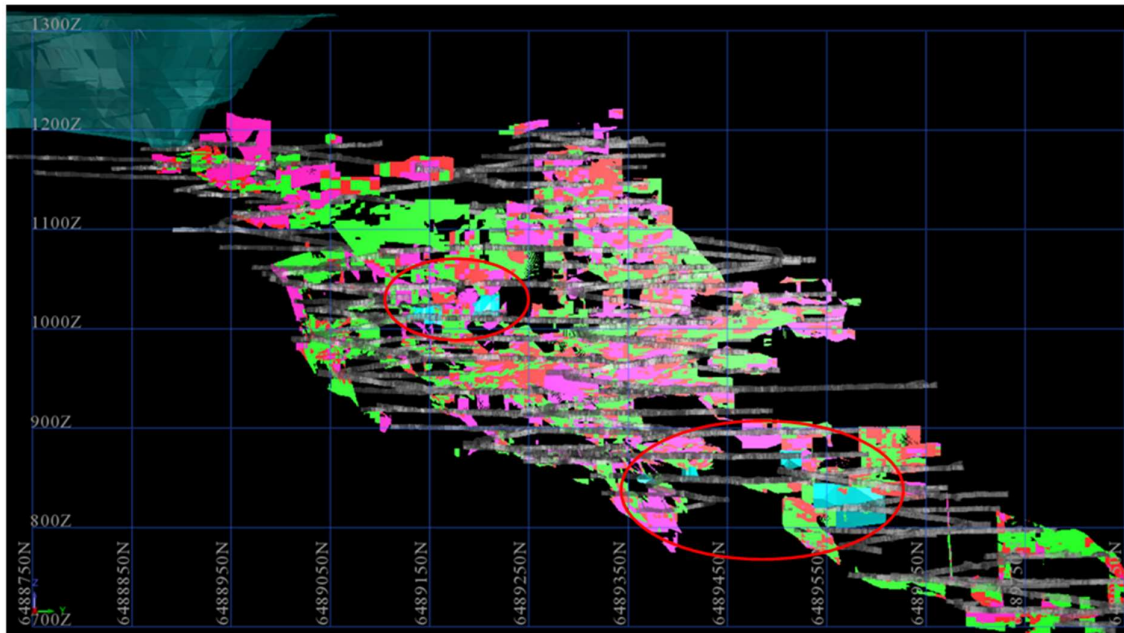

The Trident Mineral Resource estimate as set out in Table 14-7 is effective as of September 30, 2023.

Table 14-7 The Trident Mineral Resource by area

Area	Measured			Indicated			Measured & Indicated			Inferred		
	Kt	g/t	Koz	Kt	g/t	Koz	Kt	g/t	Koz	Kt	g/t	Koz
Poseidon	-	-	-	106	6.62	23	106	6.62	23	556	3.33	59
Eastern Zone	-	-	-	168	4.43	24	168	4.43	24	9	5.59	2
Athena	104	5.37	18	110	6.52	23	214	5.96	41	24	7.33	6
Western Zone	179	3.30	19	-	-	-	179	3.30	19	28	2.90	3
EOS & E-Veins	21	4.64	3	239	4.33	33	260	4.35	36	9	2.94	1
Apollo	190	2.98	18	25	3.28	3	215	3.02	21	29	4.95	5
Artemis	12	20.10	8	49	4.18	7	61	7.23	14	2	19.87	1
Helios	73	3.25	8	18	7.80	5	91	4.15	12	166	2.19	12
Ares	-	-	-	2	4.71	0	2	4.71	0	60	2.81	5
Pluto	-	-	-	-	-	-	-	-	-	293	2.49	23
Total Trident	578	3.95	73	717	5.07	117	1,296	4.57	190	1,176	3.08	116

- 1) Mineral Resources that are not Mineral Reserves do not have demonstrated economic viability. There is no certainty that Mineral Resources that are not Mineral Reserves do not have demonstrated economic viability. There is no certainty that all or any part of the Mineral Resources estimated will be converted into Mineral Reserves.
- 2) The Measured and Indicated Mineral Resources are inclusive of those Mineral Resources modified to produce Mineral Reserves.
- 3) The Mineral Resource estimates include Inferred Mineral Resources that are normally considered too speculative geologically to have economic considerations applied to them that would enable them to be categorized as Mineral Reserves. There is also no certainty that Inferred Mineral Resources will be converted to Measured and Indicated categories through further drilling, or into Mineral Reserves once economic considerations are applied.
- 4) The Gold Mineral Resources are estimated using a long term gold price of USD\$1,700/oz with a USD:AUD exchange rate of 0.70.
- 5) The Trident Gold Mineral Resource was reported using a 1.3g/t cut-off grade taking into account variable operational costs associated with the Higgsville underground operations.
- 6) Classification is according to JORC Code and CIM Definition Standards Mineral Resource classification categories.

- 7) The Mineral Resource is depleted for mining to September 30, 2023.
- 8) To best represent “reasonable prospects of eventual economic extraction” the areas considered sterilised by historical mining are removed from the Mineral Resource estimation.
- 9) Mineral Resource tonnage and contained metal have been rounded to reflect the accuracy of the estimate, and numbers may not add due to rounding.
- 10) Gold Mineral Resource estimates were prepared under the supervision of Qualified Persons S. Devlin, FAusIMM (Chief Geological Officer, Karora Resources)

14.3.2 Eundynie Group

14.3.2.1 Summary

The Eundynie Group of deposits includes the Hidden Secret and Mouse Hollow deposits (and a ‘Link Zone’ separating the two deposits). A Mineral Resource estimate was completed in April 2020 by Trepanier Pty Ltd (Barnes, 2020). Hidden Secret, and part of the Link Zone, were subsequently mined by Karora via open pit from August 2020 to January 2022. During May 2022, the Mouse Hollow model was updated by Karora following the completion of grade control drilling. This deposit was mined by Karora via open pit from April 2023 to July 2023. The Hidden Secret mineral resource has been completely depleted through open pit mining and no remnant resource is being reported in this summary.

The Mouse Hollow estimate was based on surface drilling completed to 10 m northing sections and 10 m spaced holes on section. Subsequent infill grade control drilling to 5 m by 5 m were completed across most of the deposit.

At Mouse Hollow, the interpreted mineralisation was based on a 0.4 g/t Au cut-off.

Estimates of recoverable resources were derived using ordinary kriging and inverse distance interpolation methods utilising 1 m composites.

The MRE is reported at a 0.5 g/t Au cut-off within a US\$1,700 optimised pit shell and depleted to end of mining.

14.3.2.2 Drilling and Sample Data

The database used in the estimate was exported from the Karora server on May 2, 2022. The exported data were constrained to spatial extents that encompassed both deposits and includes records for 3,020 drill holes which are predominantly RC (2,946). The export includes aircore, RAB and auger holes which were excluded from all estimates but utilised in the lode interpretations. Only two diamond holes have been completed at the deposits. Drilling has been positioned using MGA94 grid coordinates. A summary of drilling at the deposit is shown in Table 14-8.

Table 14-8 Database export – May 2022

Hole Type	Count	Sum (m)
AC	10	250
DDH	2	399
RAB	49	2,492
RC	2,946	101,182
RC/DDH	13	2,254
Total	3,020	106,577

For the Mouse Hollow model update, a total of 441 drill holes intersected the defined lodes and included 438 RC and 3 RC/DDH holes for a total of 4,692 intersection metres. The drilling to May 2022 is shown in Figure 14-10.

Figure 14-10 Drilling at Hidden Secret/Mouse Hollow – database export May 2022

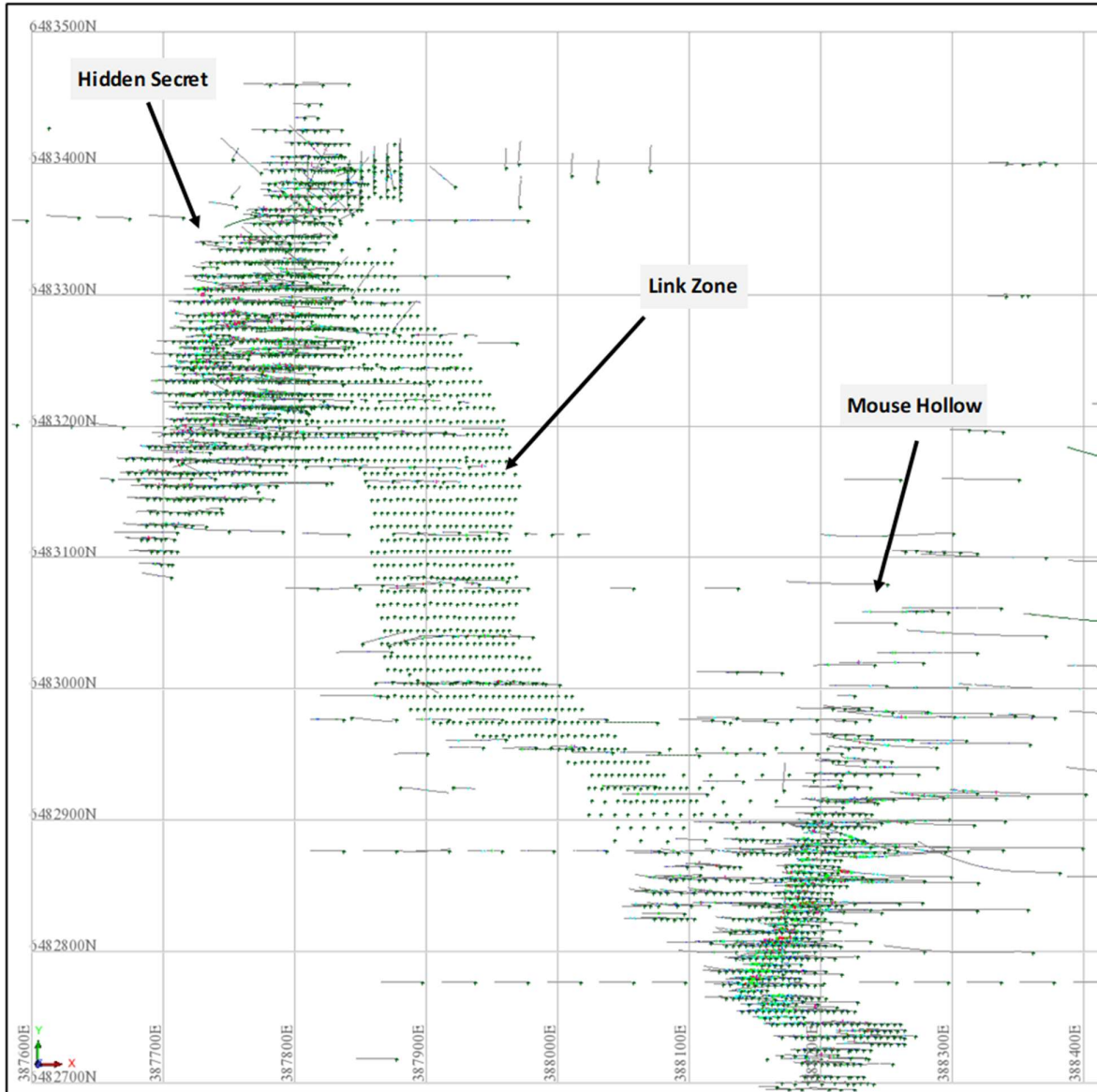

14.3.2.3 Modelling Domains

At Mouse Hollow, the interpreted mineralisation was based on a 0.4 g/t Au cut-off and resulted in 12 domains being interpreted. Within the main lode, an internal high-grade domain was interpreted using a 3 g/t Au cut-off. An anomalous zone of supergene mineralisation occurs at surface over most of the southern half of Mouse Hollow. The main primary lode dips to the east at approximately 55° and bifurcates at depth. Toward the south, this lode forms a series of stacked lenses that merge toward the surface with an associated increase in observed gold grade. The lode is offset and truncated in the south (possibly structurally).

The interpreted sectional outlines were manually triangulated to form wireframes using the downhole Au grades in association with the logged lithology and vein occurrence. To form ends to the wireframes, the end section strings were copied to a position 20 m from the section or midway to the next section, and adjusted to match the dip, strike and plunge of the zone. Lodes were extended at depth to a distance that was half the distance to the previous up-dip mineralised intersection (up to 50 m extrapolation).

A minimum downhole length of 2 m was used with no edge dilution. To allow for continuity, up to 2 m of internal dilution was included in some intersections. In situations where the structural continuity of the lode was interpreted to persist, lower grade assays were included.

The wireframes were set as solids after being validated using GEOVIA Surpac™ V7.4.

The updated May 2022 interpretation for Mouse Hollow and the July 2023 final end of mine (EOM) pit are shown in Figure 14-11 and a section view is shown in Figure 14-12. The Link Zone was re-interpreted based on GC drilling and subsequently renamed Hidden Secret South.

Figure 14-11 Mineralisation wireframes interpreted in 2022 with drilling and final July 2023 Mouse Hollow Pit

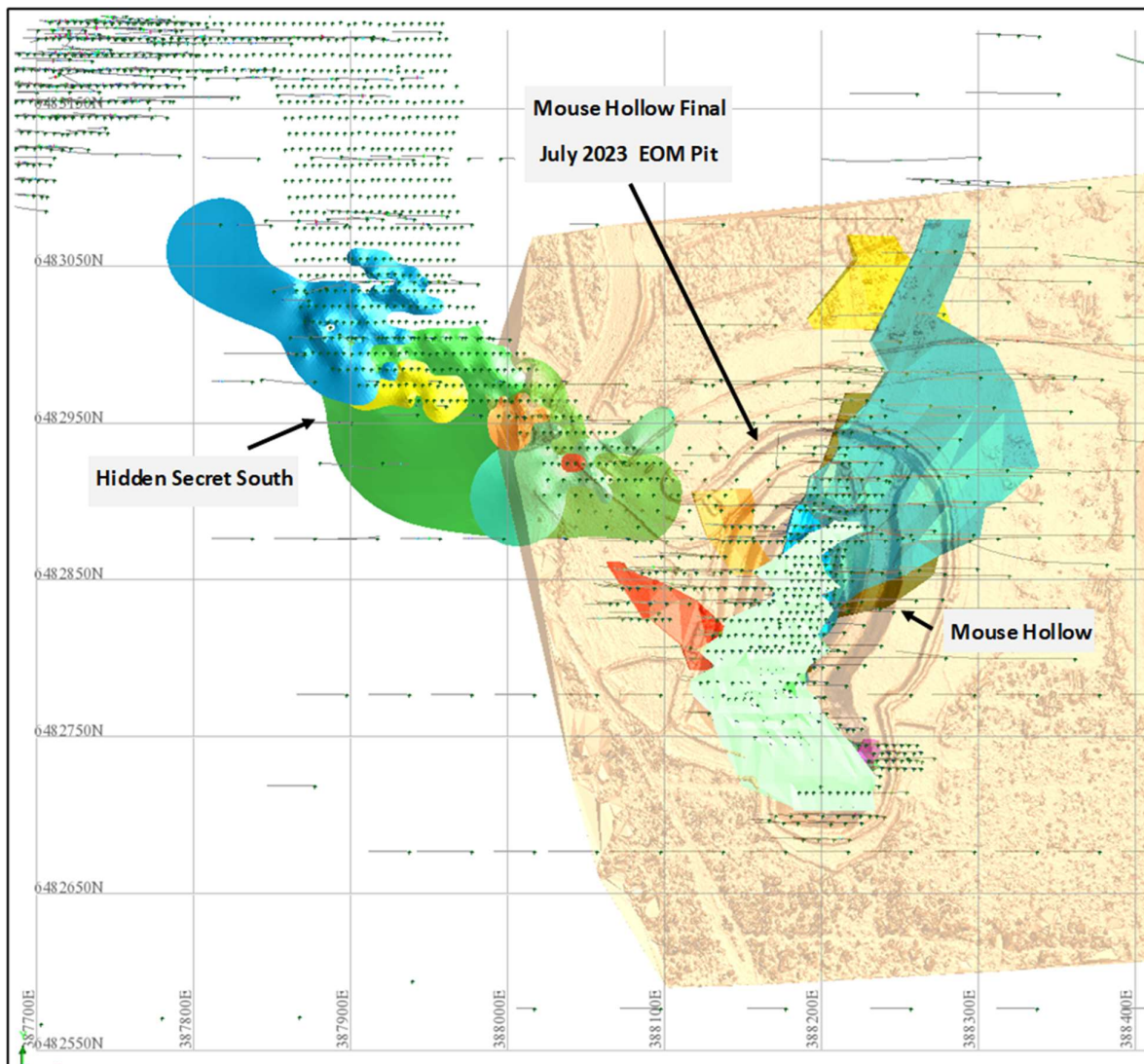
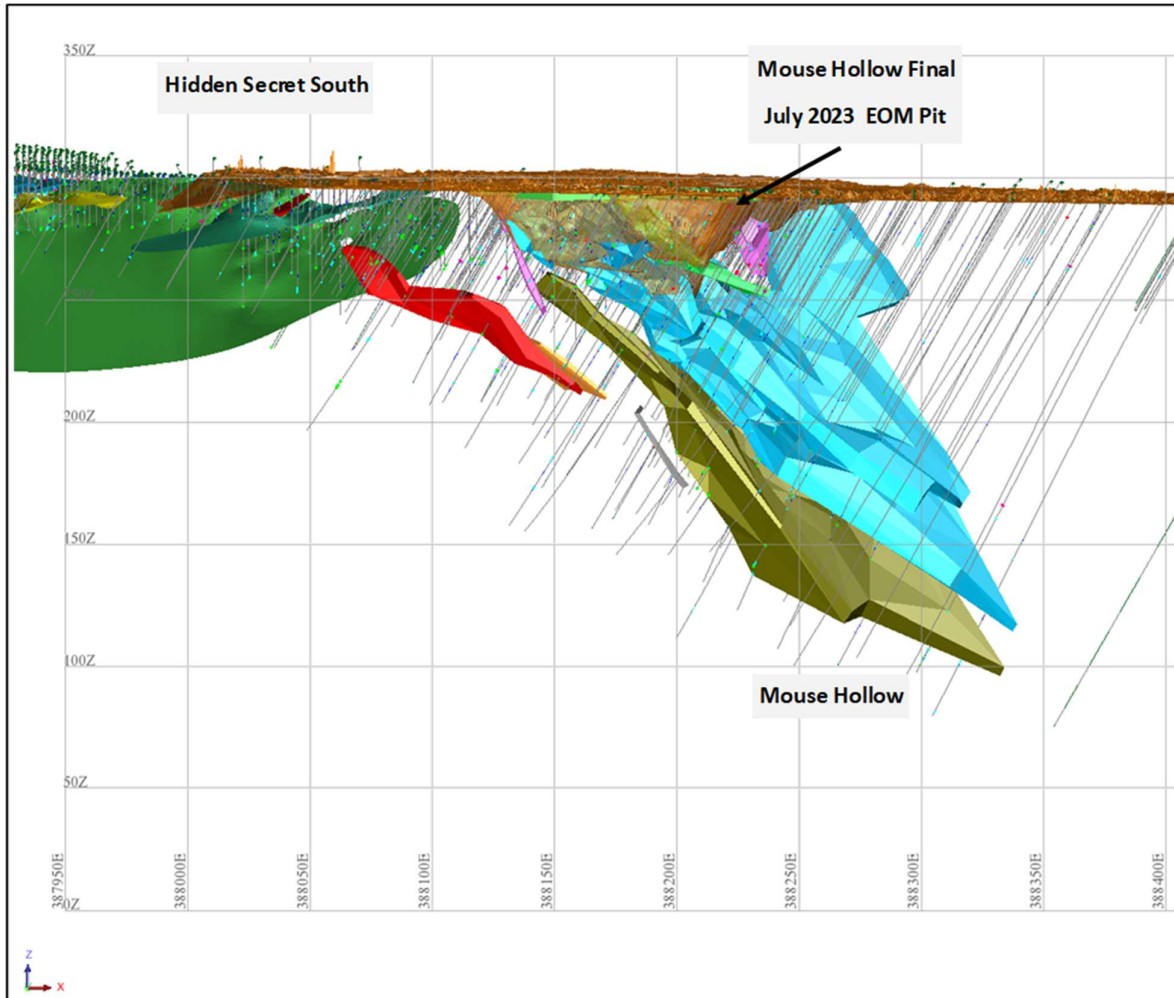

Figure 14-12 Mineralised wireframe interpretation 2022 and Mouse Hollow July 2023 EOM pit



The base of complete oxidation (BOCO) and top of fresh rock (TOFR) surfaces were generated by site geologists using Leapfrog software and geological logging.

14.3.2.4 Statistical Analysis and Compositing

The wireframes of the gold mineralised lodes were used to code the drill hole intersection into the database to allow identification of the resource intersections. GEOVIA Surpac™ was used to extract downhole gold composites within the different resource domains. Holes were composited to 1 m with a minimum of 0.3 m. The composites were checked for spatial correlation with the objects, the location of the rejected composites, and zero composite values. Individual composite files were created for each of the domains in the wireframe models.

To assist in the selection of appropriate high-grade cuts, the 1 m composite data were loaded in Supervisor software, and histograms and probability plots were generated for each domain.

Each domain was analysed individually, reviewing percentile charts, log probability plots and histograms to determine any points of distribution decay or disintegration.

Summary statistics for the Mouse Hollow domains are shown in Table 14-9. A coefficient of variation (CV) greater than 1.5 generally indicates that the data do not have a normal

distribution. As the CV increases, so do the positive skew and the number of high outliers. Analysis of each domain showed that several lodes required grade capping. A grade cap value of between 5 and 20 was applied to nine domains which resulted in a total of 10 composites being capped out of 4,691 composites which equates to 0.2% of the data.

Table 14-9 Statistical summary Mouse Hollow – 2022 Model

Domain	Count	Min	Max	Mean	CV	Grade Cap			Values
						Value	Mean	CV	Cut
1	2,669	0.01	37.1	0.99	1.38	20	0.98	1.22	2
2	246	0.01	67.4	1.95	2.59	20	1.74	1.67	2
3	226	0.01	9.12	0.98	1.23	5	0.98	1.23	0
4	347	0.01	30.7	1.94	1.75	20	1.85	1.50	4
5	678	0.01	23	0.43	2.92	5	0.43	2.92	0
6	27	0.01	7.09	0.96	1.71	5	0.96	1.71	0
7	15	0.22	17.6	2.05	2.07	5	2.05	2.07	0
8	45	0.08	15.28	1.43	1.59	10	1.31	1.21	1
9	20	0.01	3.59	0.71	1.26	-	0.71	1.26	0
10	26	0.01	2.9	0.88	1.01	-	0.88	1.01	0
11	12	0.57	4.65	1.73	0.71	-	1.73	0.71	0
18	61	0.04	12.8	1.38	1.49	10	1.33	1.36	1
101	319	0.09	19.5	4.21	0.68	-	4.21	0.68	0

Due to the absence of SG determinations at Mouse Hollow, bulk densities have been assumed from nearby comparable Karora operations with extensive mining history: Table 14-10.

Table 14-10 Assumed bulk densities

	Bulk density t/m ³
Oxide	1.8
Transition	2.4
Fresh basalt	2.7
Fresh gabbro	2.89

14.3.2.5 Variography

Understanding the grade continuity and determining its extent and orientation is achieved through interpreting and modelling the experimental variogram. The experimental variogram requires sufficient sample data to provide a reliable measure of the grade continuity.

The downhole variogram provides the best estimate of the true nugget. Directional variograms were modelled by domain using traditional variograms.

For the 2022 Mouse Hollow domains, a two-structured nested spherical model was found to model the experimental variograms reasonably well. The true nugget value was generally low to moderate (from 0.17 to 0.49). Directional variograms were modelled for five domains and these parameters were applied to the minor lodes where there were insufficient samples to model.

14.3.2.6 Block Model and Grade Estimation

The block model was originally created in October 2021 using GEOVIA Surpac™ to encompass the full extent of the deposit. This model was updated with the new adjusted lodes at Mouse Hollow. A parent block size of 2.5 m NS x 2.5 m EW x 2.5 m vertical with sub-blocking to 1.25 m x 1.25 m x 1.25 m was used. The selected parent block size was based on the results of a kriging neighbourhood analysis (KNA) and is comparable to 50% of the average closest GC drill hole spacing.

Ordinary kriging (OK) was used for the grade interpolation as it allowed the measured spatial continuity to be incorporated into the estimate and results in a degree of smoothing which is appropriate for the disseminated nature of the mineralisation.

The ID³ interpolation was used as a check estimate.

The wireframes were used as a hard boundary for the grade estimation of each domain. That is, only grades inside each lode were used to interpolate the blocks inside the lode.

An 'ellipsoid' search orientated to reflect the geometry of the individual lodes was used to select data for interpolation. The search ellipse was based on the kriging parameters but adjusted to reflect the local changes in each of the minor lodes. Three estimation passes were used for the interpolations with parameters based on the variogram models. First pass distances varied between 8 m and 20 m dependant on domain, and these were doubled for each successive pass. A maximum of four samples per drill hole was imposed. The minimum number of informing composites was set to either 6 or 10 for the first pass, reduced to either 4 or 6 in the second pass, and set to two in the final pass.

14.3.2.7 Model Validation

The following three-step process was used to validate the estimate through the entire deposit:

- A visual assessment was completed by slicing sections through the block model in positions coincident with drilling.
- A quantitative assessment was completed by comparing the average grades of the composite file input against the block model output for all the lodes.
- For the main domains, trend swath plots were generated in various orientations across strike, along strike and at elevation.

The validation indicates that the mineral resource model replicates the source input data well in regions of higher density drilling. Smoothing is evident in domains with limited input data; however, the estimate is considered appropriate as the trends in the data are adequately reproduced.

14.3.2.8 Mineral Resource Classification

The Mineral Resource was classified in accordance with the JORC Code 2012 guidelines. A reconciliation of this reporting and the CIM Definition Standards (2014) by the Qualified Person shows no material differences.

The deposit has been classified as Measured, Indicated or Inferred Mineral Resource based on a combination of quantitative and qualitative criteria which included geological continuity and confidence in volume models, data quality, sample spacing, lode continuity and estimation parameters. The Measured category was applied to those areas defined by 5 m spaced GC drilling. The Indicated portion of the Mineral Resource was defined across the main lodes

through areas that had generally been filled in either the first or second estimation pass and defined by drilling at 10 m to 40 m spacing. Digitised strings were used to form regular shapes to code these areas. The remainder of the lodges were classified as Inferred Mineral Resource.

14.3.2.9 Mineral Resource Reporting

The Mineral Resource Statement presented herein sets out the Gold Mineral Resource estimate prepared in accordance with the Canadian Securities Administrators' National Instrument 43-101 and Form 43-101F. The Mineral Resource estimate as set out in Table 14-11 is effective as of September 30, 2023. The Mineral Resource at the Mouse Hollow deposit has been reported using a cut-off at 0.5 g/t Au and has been depleted for open pit mining. The estimate contains approximately 0.7 Mt @ 1.4 g/t Au for 30,000 oz.

Table 14-11 Mouse Hollow Deposit September 2023 Mineral Resource Estimate

MRE Summary	Measured			Indicated			Measured & Indicated			Inferred		
	kt	g/t	koz	kt	g/t	koz	kt	g/t	koz	kt	g/t	koz
Mouse Hollow	31	1.0	1	638	1.4	29	669	1.4	30	27	0.9	1

- 1) Mineral Resources that are not Mineral Reserves do not have demonstrated economic viability. There is no certainty that all or any part of the Mineral Resources estimated will be converted into Mineral Reserves.
- 2) The Measured and Indicated Mineral Resources are inclusive of those Mineral Resources modified to produce Mineral Reserves.
- 3) The Mineral Resource estimates include Inferred Mineral Resources that are normally considered too speculative geologically to have economic considerations applied to them that would enable them to be categorized as Mineral Reserves. There is also no certainty that Inferred Mineral Resources will be converted to Measured and Indicated categories through further drilling, or into Mineral Reserves once economic considerations are applied.
- 4) The Gold Mineral Resources are estimated using a long-term gold price of US\$1,700/oz with a USD:AUD exchange rate of 0.70.
- 5) The Gold Mineral Resource was reported using a 0.5 g/t cut-off grade taking into account variable operational costs associated with the Higgsinsville Open Pits.
- 6) Classification is according to JORC Code and CIM Definition Standards Mineral Resource classification categories.
- 7) The Mineral Resource is depleted for mining to September 30, 2023.
- 8) To best represent "reasonable prospects of eventual economic extraction", the Mineral Resource for open pits has been reported within an optimized pit shells at A\$2,429/oz (US\$1,700/oz).
- 9) Mineral Resource tonnage and contained metal have been rounded to reflect the accuracy of the estimate, and numbers may not add due to rounding.
- 10) Gold Mineral Resource estimates were prepared under the supervision of Qualified Person S. Devlin, FAusIMM (Chief Geological Officer, Karora Resources).

14.3.3 Fairplay North

14.3.3.1 Summary

The Fairplay group of deposits (Fairplay, Fairplay East, Fairplay North and Two Boys) form part of the Line-of-Lode within the HGO Central group of deposits and are located approximately 2 km south of the Higgsinsville Mill, accessible via an unsealed haul road.

The Fairplay North deposit was actively mined in 2020. Mineralisation is hosted within a dolerite/gabbro mafic unit that sits parallel to the Poseidon Thrust. The mineralisation is associated with quartz veining, arsenopyrite and is heavily sheared due to being adjacent to the Poseidon Thrust. There are two types of quartz veining, massive and vuggy, with mineralisation only associated with the massive quartz veining. The mineralised quartz dips approximately 25°

towards the east away from the Poseidon Thrust and steepens up and dips parallel (approximately 60° towards the east) closer to the Poseidon Thrust.

14.3.3.2 Modelling Domains

Mineralised envelopes were modelled using an approximate 0.5 g/t Au envelope and were separated into structurally controlled primary plus supergene estimation domains. Wireframes were created in Leapfrog software for the supergene/oxide domains (1 to 3) and the main primary structural domains (1001 to 1020). A plan view of the mineralisation interpretation is shown in Figure 14-13 and a section view is shown in Figure 14-14.

Figure 14-13 Plan view of the Fairplay North gold mineralised system

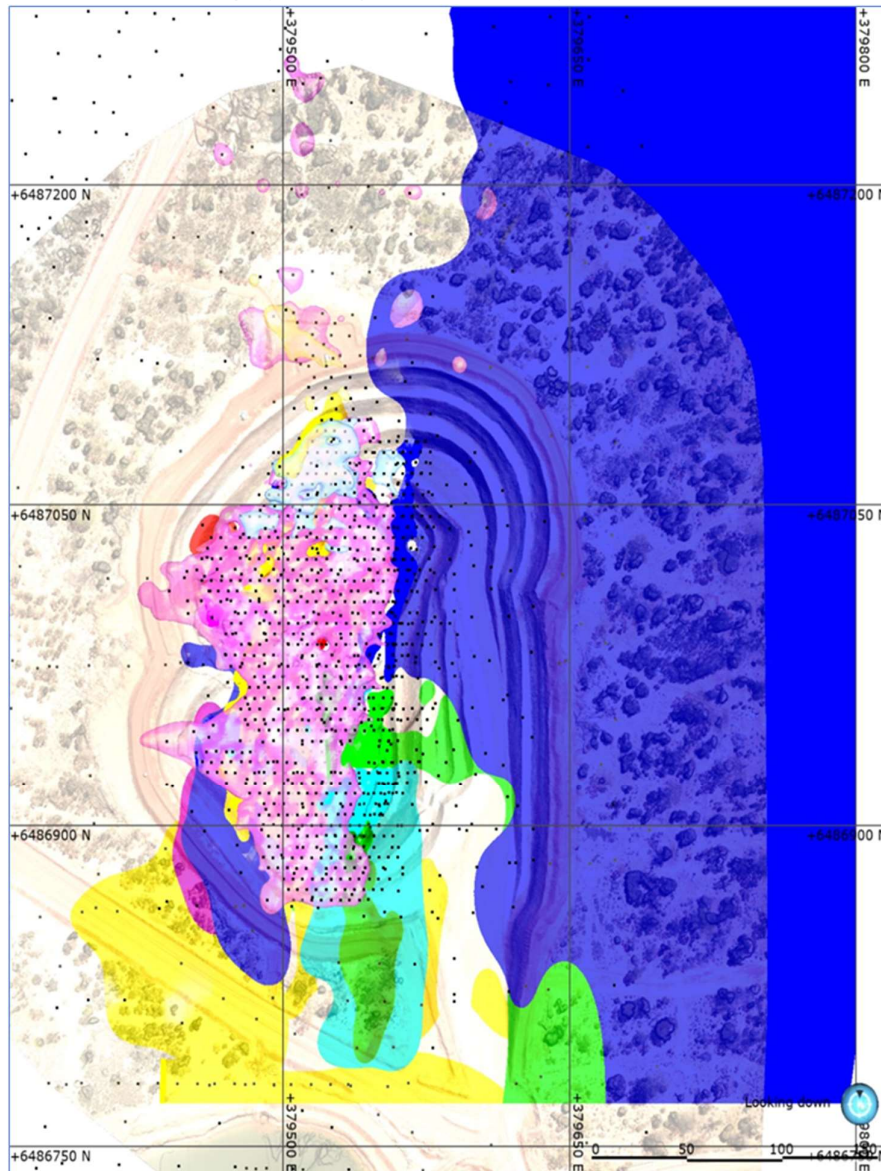
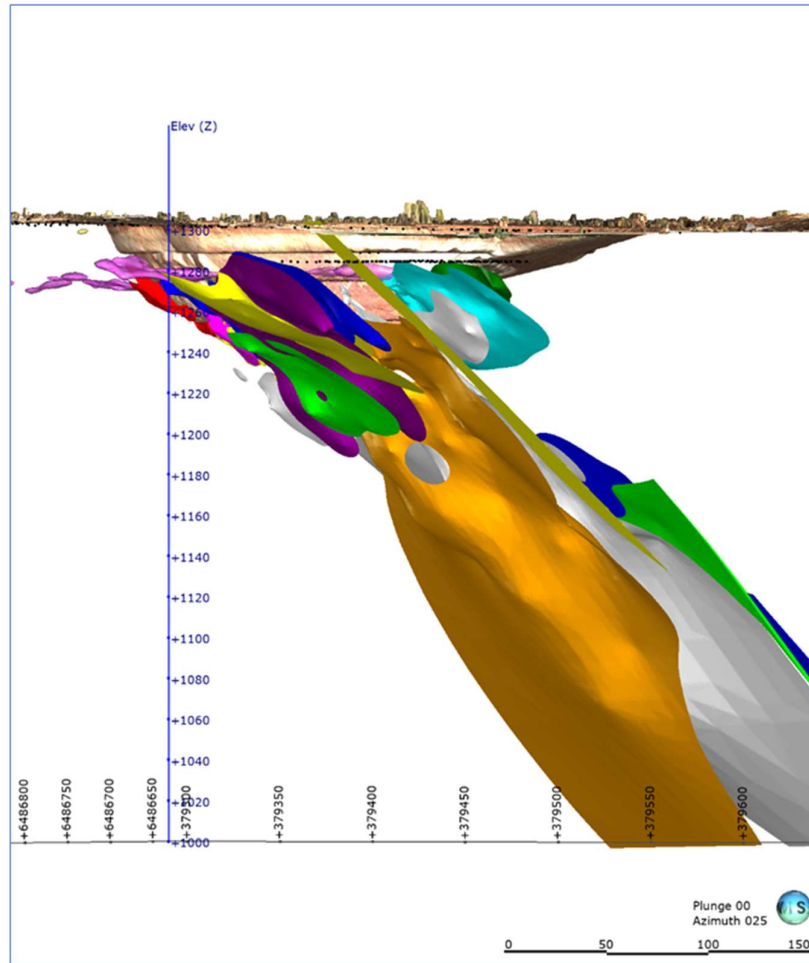

Figure 14-14 Oblique view of the Fairplay North gold mineralised system looking NNE



Weathering surfaces base of alluvial BOA, BOCO and TOFR were based on the logging of weathering codes within the drill database.

14.3.3.3 Statistical Analysis and Compositing

The coded drill hole database was composited to 1 m composites within each of the domains. All RC (including grade control) sampling was undertaken at a 1 m sample interval. This, along with consideration of the typical dimensions and attitudes of the mineralised structures and veins combined to deem a 1 m composite length appropriate. Samples were composited with parameters set such that, after compositing, there were no residuals (intervals <1 m) for any of the domains.

Basic statistics for the 1 m Au composites for each of the mineralised domains were determined. Outlier investigations were also completed based on both distribution statistics (histograms and probability plots), relative clustering of higher-grade data in spacing, and investigations of metal at risk. From these analyses, high grade cuts or caps were selected as detailed in Table 14-12.

Table 14-12 Statistics and top-cuts applied to Fairplay North domains (Au ppm)

Domain	No. Comps	Max.	Cut	Uncut Mean	Cut Mean	No. Data Cut	% Metal Reduction
1001	5200	145	40	1.50	1.45	6	2.8%
1002	527	16.6	-	0.89	-	-	-
1003	511	18.8	-	1.20	-	-	-
1004	112	9.23	-	0.86	-	-	-
1005	194	16.98	-	1.04	-	-	-
1006	1127	74.8	35	1.20	1.17	1	2.9%
1007	2373	80.52	25	1.17	1.13	6	3.8%
1008	155	34.4	15	1.57	1.44	1	8.0%
1009	110	31.4	10	0.96	0.77	1	20.1%
1010	134	138.67	10	2.27	1.22	2	46.5%
1011	324	18.1	-	1.32	-	-	-
1012	320	25.4	15	1.00	0.96	1	3.3%
1013	39	9.53	-	0.98	-	-	-
1014	109	8.3	-	0.88	-	-	-
1015	37	4.315	-	1.01	-	-	-
1016	53	5.05	-	1.14	-	-	-
1017	83	45.6	20	2.08	1.77	1	14.8%
1018	141	18.7	10	1.02	0.94	2	7.7%
1019	27	14.5	-	2.30	-	-	-
1020	11	4.16	-	1.11	-	-	-
1	349	41.5	10	1.01	0.80	5	20.9%
2	45	15.004	-	1.71	-	-	-
3	4420	145	40	1.21	1.17	4	3.1%

Densities for Fairplay were assigned within the block model using historical production information from the Fairplay open pit. The bulk density values were assigned as an average value to the alluvial cover plus the three weathering domains: oxide, transition and fresh (Table 14-13).

Table 14-13 Densities applied for the Fairplay North open pit model

Material	Bulk Density (t/m ³)
Alluvial	1.4
Oxide	1.8
Transitional	2.4
Fresh Gabbro	2.89

14.3.3.4 Variography

Modelled directional variograms used log transformation of the data converting skewed grade distributions to a standard normal distribution, thereby limiting the effect of extreme grades. The log variogram models were back transformed for use in the estimation (Table 14-14).

The variograms were generally poorly formed except for domain 1001, which contained the most samples (Figure 14-15). The oxide domains were modelled together with the results applied to all (Figure 14-16).

Table 14-14 Variogram model parameters for the Fairplay North estimation

Domain	C0	A1				A2				vgrot bearing	vgrot plunge	vgrot dip
		C1	X	Y	Z	C2	X	Y	Z			
10011	0.35	0.35	10	7	5	0.3	53	26	12	40	0	-20
1006	0.42	0.34	5	5	7	0.24	14	9	17	343.5	9.4	69.7
1007	0.34	0.39	8	4	8	0.27	23	14	23	5.4	37.15	-16.0
1 to 32	0.57	0.26	12	15	11	0.17	63	33	62	339.4	-3.4	-19.7

- 1) Used for domains 1001 to 1005 and 1008 to 1020.
- 2) Used for all oxide domains including 1 to 3.

Figure 14-15 Fairplay North variogram – Domain 1001

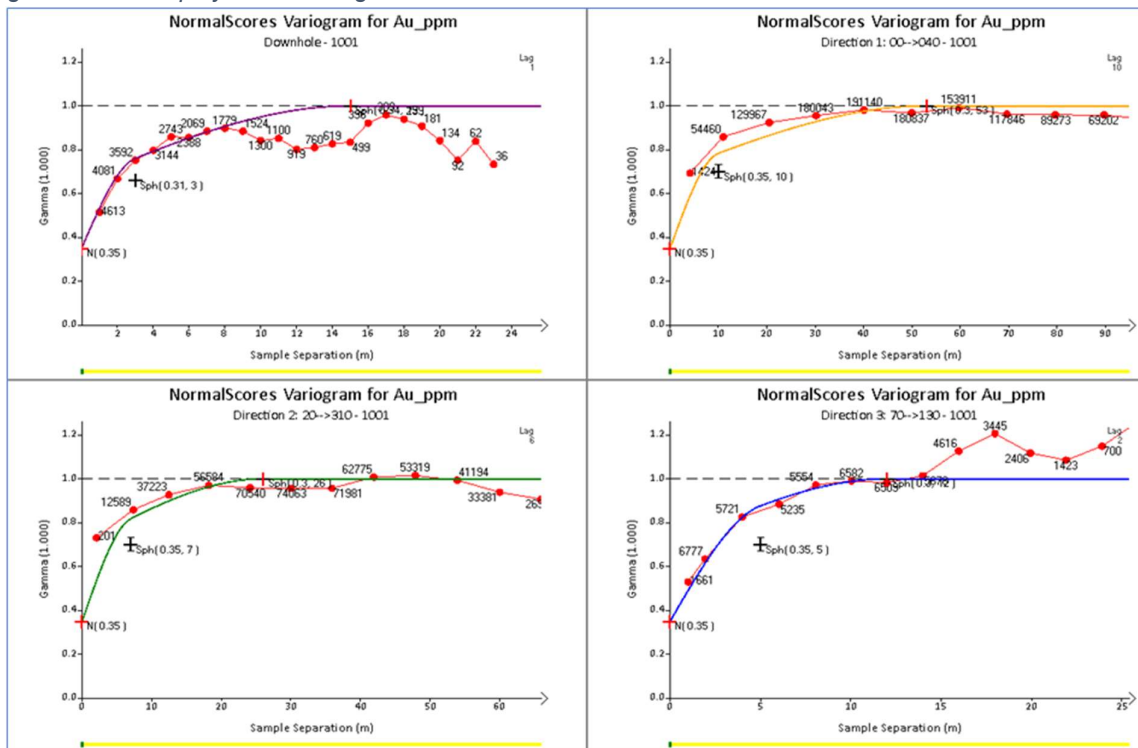
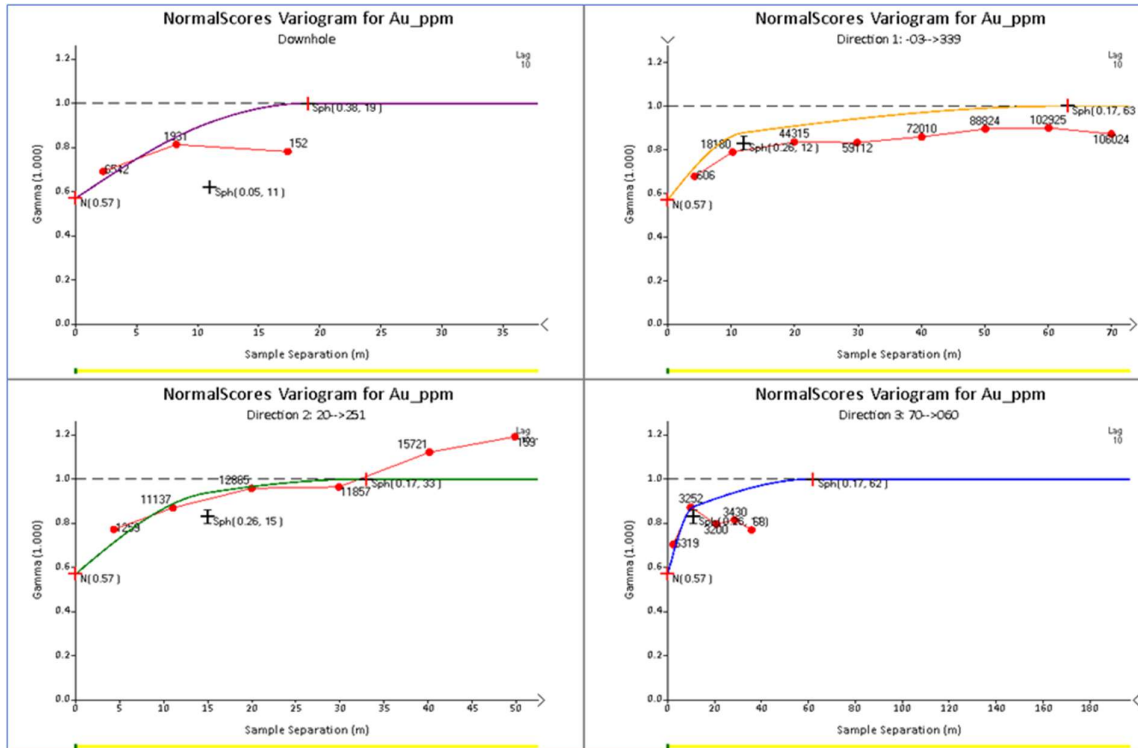

Figure 14-16 Fairplay North variogram – oxide Domains 1 to 3 combined



14.3.3.5 Block Model and Grade Estimation

Grade estimation was completed using ordinary kriging (OK) in GEOVIA Surpac™ software into the mineralised domains. The estimate was resolved into parent cells that had been sub-celled at the domain boundaries for accurate domain volume representation. The wireframes were used as a hard boundary for the grade estimation of each domain. That is, only grades inside each lode were used to interpolate the blocks inside the lode.

An 'ellipsoid' search orientated to reflect the geometry of the individual lodges was used to select data for interpolation. The search ellipse was based on the kriging parameters but adjusted to reflect the local changes in each of the minor lodges. Three estimation passes were used for the interpolations with parameters based on the variogram models. The first pass distance was set to 30 m, and this was doubled for the second pass and then expanded for the third pass to ensure most cells were estimated. A maximum of four samples per drill hole was imposed. The minimum number of informing composites was set to 6 and the maximum set to 12 for each estimation pass.

14.3.3.6 Model Validation

Extensive visual and statistical validation of the grade estimates was completed, including:

- Review of the block estimate and the composite data in cross-section, long-section and plan views.
- Comparison of composite grades and block model grades broken down into northing, easting and/or elevation zones.
- Comparison of the mean grade of the contributing composites versus the mean grade of the estimate.

The validation indicates that the Mineral Resource model replicates the source input data well in regions of higher density drilling. Swath plots were created and show that for the regions of domains where data density is lower, smoothing is evident; however, the estimate is considered appropriate as the trends in the data are adequately reproduced.

14.3.3.7 Mineral Resource Classification

The Mineral Resource has been defined using definitive criteria determined during the validation of the grade estimates, with detailed consideration of the classification guidelines. The deposit has been classified as Measured, Indicated or Inferred Mineral Resource based on a combination of quantitative and qualitative criteria:

- Drill spacing (with grade control infill in places down to 5 m x 5 m);
- Confidence in geological interpretation;
- Confidence in mineralised zone interpretation;
- Sample and geochemical analysis quality; and
- Availability of bulk density data.

Previous mining by open pit methods has been coded into the resource block model and reporting of resources was depleted accordingly.

The Fairplay North Mineral Resource was classified in accordance with the JORC Code 2012 guidelines. A reconciliation of this reporting and the CIM Definition Standards (2014) by the Qualified Person shows no material differences.

14.3.3.8 Mineral Resource Reporting

The Mineral Resource Statement presented herein sets out the Gold Mineral Resource estimate prepared in accordance with the Canadian Securities Administrators' National Instrument 43-101 and Form 43-101F. The Mineral Resource estimate as set out in Table 14-15 is effective as of September 30, 2023. The Mineral Resource at the Fairplay North deposit has been reported using a cut-off at 0.5 g/t Au and has been depleted for open pit mining. The estimate contains approximately 0.4 Mt @ 1.4 g/t Au for 19,000 oz.

Table 14-15 Fairplay North Deposit September 2023 Mineral Resource Estimate

MRE Summary	Measured			Indicated			Measured & Indicated			Inferred		
	kt	g/t	koz	kt	g/t	koz	kt	g/t	koz	kt	g/t	koz
Fairplay North	204	1.3	9	226	1.4	10	430	1.4	19	0.2	2.5	0.01

- 1) Mineral Resources that are not Mineral Reserves do not have demonstrated economic viability. There is no certainty that all or any part of the Mineral Resources estimated will be converted into Mineral Reserves.
- 2) The Measured and Indicated Mineral Resources are inclusive of those Mineral Resources modified to produce Mineral Reserves.
- 3) The Mineral Resource estimates include Inferred Mineral Resources that are normally considered too speculative geologically to have economic considerations applied to them that would enable them to be categorized as Mineral Reserves. There is also no certainty that Inferred Mineral Resources will be converted to Measured and Indicated categories through further drilling, or into Mineral Reserves once economic considerations are applied.
- 4) The Gold Mineral Resources are estimated using a long-term gold price of US\$1,700/oz with a USD:AUD exchange rate of 0.70.
- 5) The Gold Mineral Resource was reported using a 0.5 g/t cut-off grade taking into account variable operational costs associated with the Higgsville Open Pits.
- 6) Classification is according to JORC Code and CIM Definition Standards Mineral Resource classification categories.
- 7) The Mineral Resource is depleted for mining to September 30, 2023.

- 8) To best represent 'reasonable prospects of eventual economic extraction', the Mineral Resource for open pits has been reported within an optimized pit shells at A\$2,429/oz (US\$1,700/oz).
- 9) Mineral Resource tonnage and contained metal have been rounded to reflect the accuracy of the estimate, and numbers may not add due to rounding.
- 10) Gold Mineral Resource estimates were prepared under the supervision of Qualified Person S. Devlin, FAusIMM (Chief Geological Officer, Karora Resources).

14.3.4 Fairplay Main

14.3.4.1 Summary

The Fairplay group of deposits (Fairplay Main, Fairplay East, Fairplay North and Two Boys) form part of the Line-of-Lode within the HGO Central group of deposits and are located approximately 2 km south of the Higginsville Mill, accessible via an unsealed haul road (Figure 14-17).

Figure 14-17 Location of the HGO Central Fairplay group

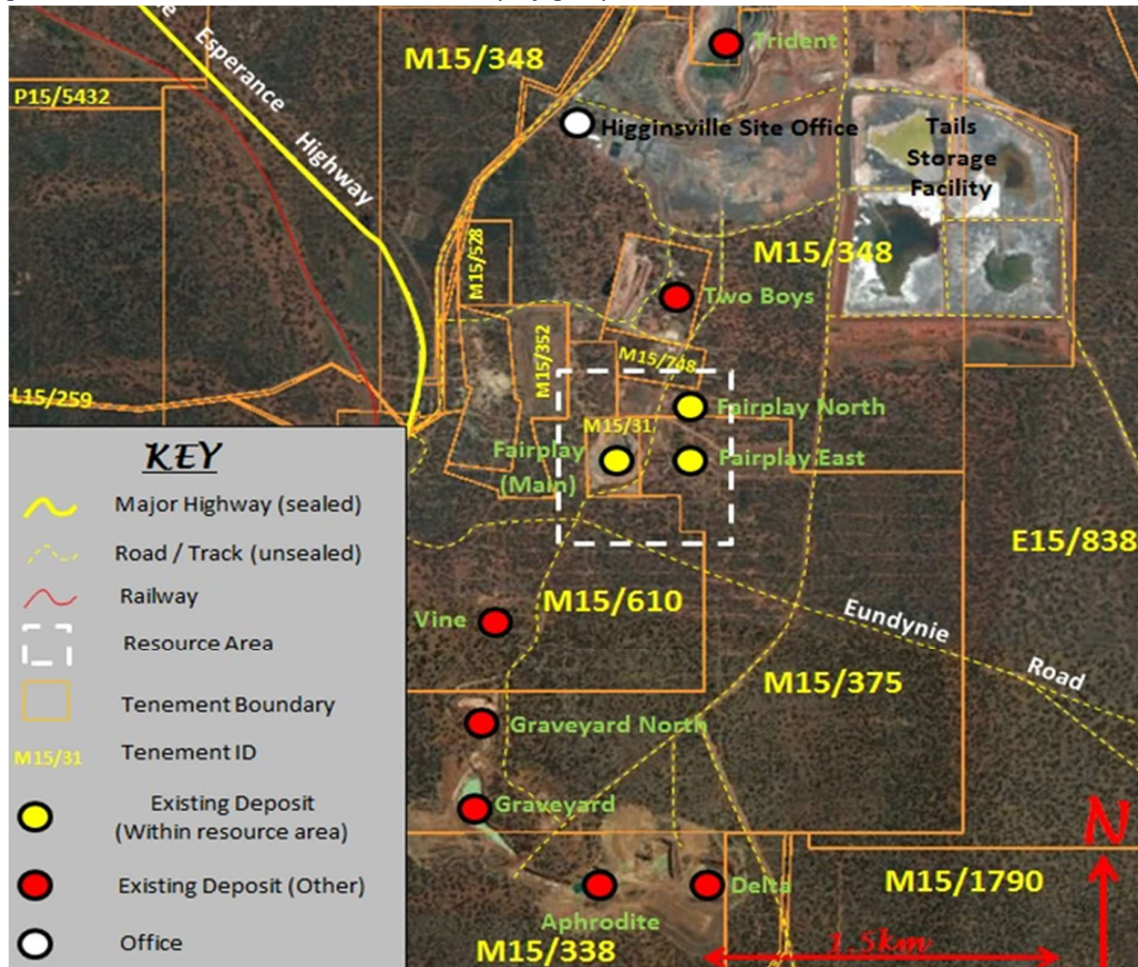

Historic production from 1949 to 2017 was 885 kt at 1.9 g/t Au for 55 koz. The last period of mining was by Metals X/Westgold from December 2015 to May 2017 (Table 14-16).

Table 14-16 Historical production of the Fairplay Group deposits from 1980 to 2017

Deposit	Date	Company	Tonnes (t)	Grade (g/t)	Ounces (oz)	Comments	Reference
Fairplay (main)	Prior to 1949	Private Syndi	15,593	4.98	2,497		DMP
	March to June 1991	Samantha	100,654	2.31	7,473	Milling Figures	Walsh 1994
	July to December 1991		266,182	2.17	18,553		
	February to May 2010	Avoca	103,890	2	6,680	Unreconciled	Coxon et al 2010
	December 2015 to May 2017	Metals X / We	399,205	1.57	20,127	Reconciled mined	Fieldgate 2018
	Sub Total			885,524	1.94	55,330	
Fairplay East	March to November 2017	Westgold	185,279	1.43	8,532	Reconciled mined	Pike et al 2018
Grand Total			1,070,803	1.85	63,862		

The most recent model of Fairplay Main is a combined Fairplay Group model *fairplay_two_boys_20180331_depleted.mdl* last modified on May 5, 2018. This model is reported in Westgold (2018).

The mineralisation at Fairplay Main is hosted within the weakly differentiated gabbro unit within the Line-of-Lode zone between the Poseidon Thrust and Thrust A regional structures (Figure 14-18). The zone of mineralisation is defined either by the upper lithological contact of the gabbro or by the preferred horizon within the unit. The footwall contact of the mineralisation is highly irregular suggesting that gold bearing fluids are channelled through a series of steep southwest dipping fluid conduits.

Within the Fairplay Pit, there are two types of mineralisation:

- Main mineralisation is hosted in the gabbro unit and lies directly under and is parallel to the Fairplay Shear.
- Minor mineralisation is hosted with the basalt unit and is sub-vertical.

There is very little supergene enrichment overlying the Fairplay Deposit.

The main mineralisation which is the primary source of the ore in the Fairplay Pit lies directly under and is parallel to the Fairplay Shear. The mineralisation is characterised by disseminated arsenopyrite with minor quartz veining occurring in mostly fresh rock.

The overall ore zone dips approximately 45° to 55° to the east, strikes approximately 170° and plunges approximately 15° to the south.

The upper mineralisation zone is defined by 0.5 m to 1.0 m thick quartz vein which parallels the Fairplay Shear. The body of the mineralisation is defined by quartz veins (8 cm to 15 cm) which are perpendicular to Fairplay Shear and the upper boundary quartz vein which dips towards the west.

The minor mineralisation occurs as thin (5 m to 10 m thick) sub-vertical (dipping 75° to 85° mainly towards the east) lodes. The lodes strike between 355° to 010° and have a maximum strike distance of 70 m. The mineralisation is characterised by orange iron oxides and can be easily distinguished from the green (waste) basalt host rock. The minor mineralisation occurs above and is truncated by the Fairplay Shear. No sulphides were found in the mineralisation due to the mineralisation occurring in the oxide/transitional material.

Figure 14-18 Schematic plan of the Line-of-Lode system (Source: Westgold (2018))

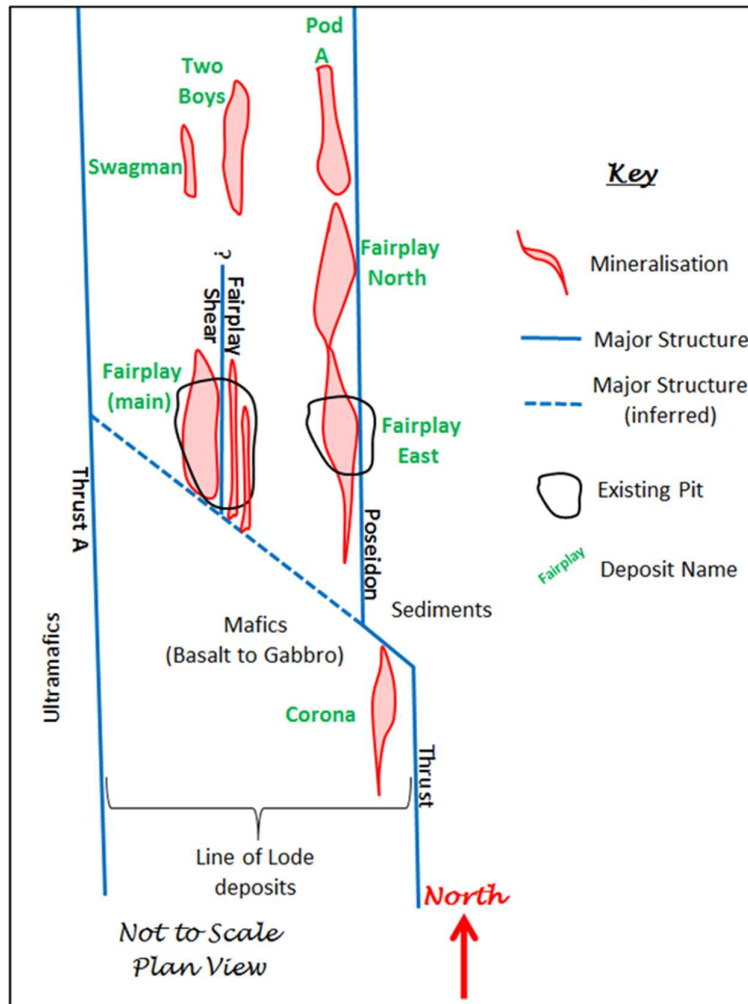

14.3.4.2 Modelling Domains

Mineralised envelopes were interpreted based on the dominant style of mineralisation and the relative spatial distribution of each. Wireframes were modelled using a 0.5 g/t Au envelope with a minimum downhole length of 2 m and a maximum internal dilution of 2 m. These were digitised on 10 m north sections (or 5 m sections through areas covered by GC drilling). A total of 48 domains were interpreted across a strike length of 360 m with a predominant west dip of between 75° and 85°.

A longsection view of the mineralisation interpretation is shown in Figure 14-19.

Using geological codes in the drill hole logging, lithological domains were interpreted for felsic and mafic intrusives, gabbro on the west side of the Line-of-Lode, ultramafic on the west side of Thrust A, and Black Flag sediments on the eastern side of the Poseidon Thrust.

Weathering surfaces were created for BOA, BOCO and TOFR.

Figure 14-19 Long-section view of the main mineralisation envelopes (looking west)

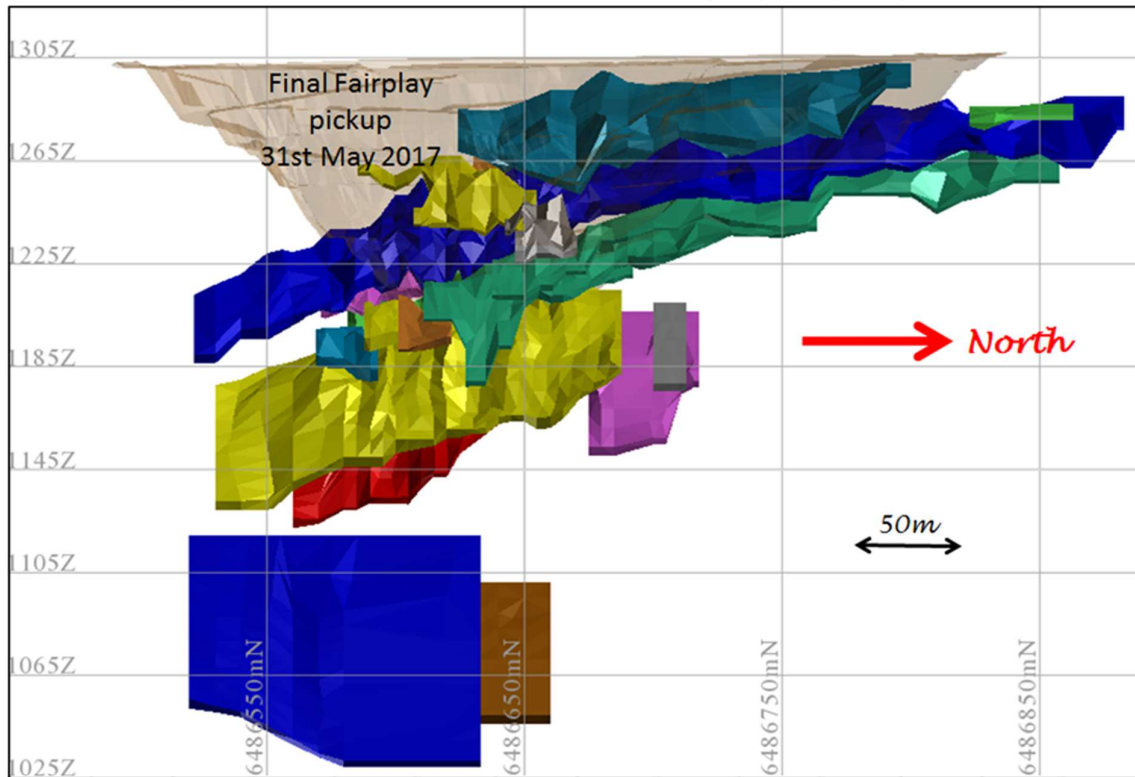

14.3.4.3 Statistical Analysis and Compositing

The coded drill hole database was composited to 1 m composites within each of the domains with a residual length of 0.5m. Approximately 86% of samples at Fairplay were taken across 1 m intervals. All drill holes were used for the wireframe interpretation; however, the RAB, Air Core, Blast hole and Auger drill holes data were excluded from compositing and geostatistical analysis.

Basic statistics for the 1 m Au composites for each of the mineralised domains were determined. Summary log histogram and log probability plot for the main Domain 101 are shown in Figure 14-20.

Outlier investigations were also completed based on both distribution statistics (histograms and probability plots), relative clustering of higher-grade data in spacing, and investigations of metal at risk. From these analyses, high grade caps were applied to 22 domains, and these varied from 10 g/t to 35 g/t.

Figure 14-20 Log histogram and Log probability plot for Fairplay (Main) Domain 101

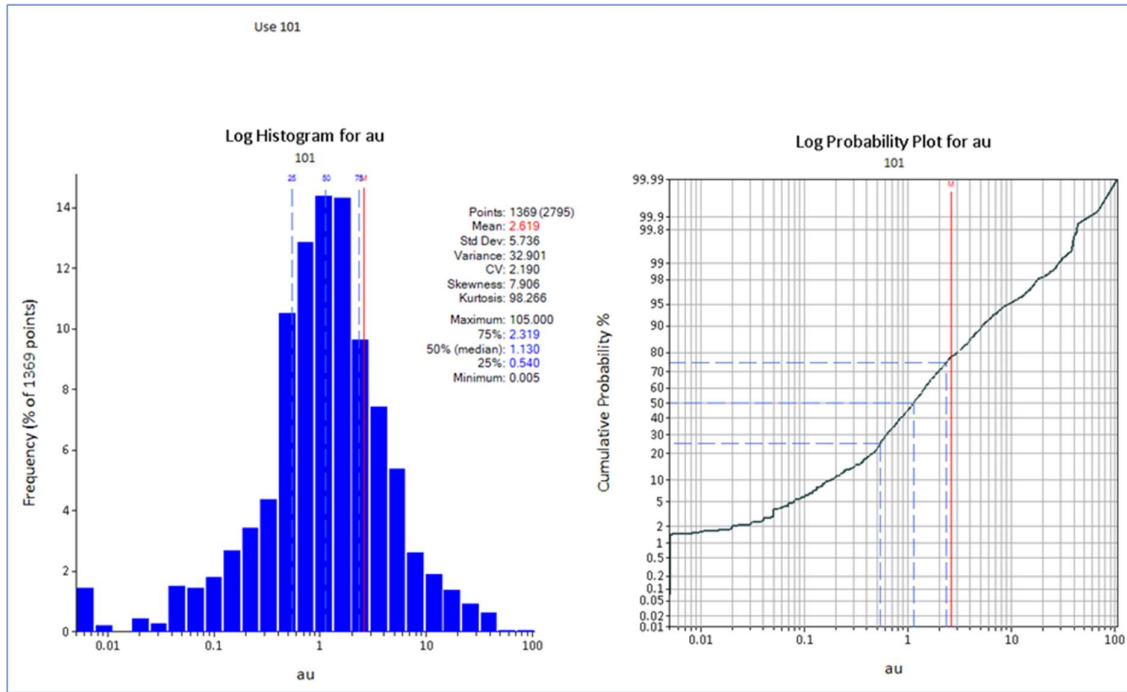

Density data were taken from previous models, both Fairplay and Trident, and from the exploration and engineering departments (Table 14-17).

Table 14-17 Bulk density values applied to Fairplay Main Model

Material	Bulk Density (g/cm ³)	Source
Cover	1.40	Discussion and agreement from Exploration Department
Oxide	1.80	From previous model
Transitional	2.40	From previous model
Fresh	2.89	From Trident Deposit
Waste Dumps / Infill	1.40	Discussion and agreement from Engineering Department

14.3.4.4 Variography

Modelled directional variograms used normal scores transformation of the data converting skewed grade distributions to a standard normal distribution, thereby limiting the effect of extreme grades. The normal score variogram models were back transformed for use in the estimation. Where applicable, domains of similar orientation, geology, and statistics were grouped together for variogram modelling.

The variograms were generally poorly formed except for Domain 101 which contained the most samples. The oxide domains were modelled together with the results applied to all (Table 14-18).

Table 14-18 Variogram model parameters for the Fairplay Main

Group	Nugget	Structure 1		Structure 2		Bearing Plunge Dip	Major	Minor
		Sill	Range	Sill	Range			
100	0.26	0.38	6	0.36	30	268.49	0.86	1
			7		18	29.5	1.67	2.5
			6		12	5.72	-	-
200	0.29	0.37	7	0.34	12	10	2.33	2.33
			3		6	0	2	2
			3		6	-40	-	-

14.3.4.5 Block Model and Grade Estimation

Grade estimation was completed using ordinary kriging (OK) in GEOVIA Surpac™ software into the mineralised domains. The estimate was resolved into parent cells that had been sub-celled at the domain boundaries for accurate domain volume representation. The wireframes were used as a hard boundary for the grade estimation of each domain. That is, only grades inside each lode were used to interpolate the blocks inside the lode.

An 'ellipsoid' search orientated to reflect the geometry of the individual lodges was used to select data for interpolation. The search ellipse was based on the kriging parameters but adjusted to reflect the local changes in each of the minor lodges. Three estimation passes were used for the interpolations with parameters based on the variogram models. The first pass distance was set to 30 m, and this was doubled for the second pass and then expanded for the third pass to ensure most cells were estimated. A maximum of four samples per drill hole was imposed. The minimum number of informing composites was set to 6 and the maximum set to 12 for each estimation pass.

The block model was created with a parent cell size of 5 m x 5 m x 5 m and sub-cells at 1.25 m in each dimension (Table 14-19).

Table 14-19 Fairplay -Two Boys block model extents and cell sizes

Axis	Minimum	Maximum	Extent	Parent size	Number of rows	Minimum subcell
Y	6,487,100	6,488,200	1,100	5	220	1.25
X	378,800	380,000	1,200	5	240	1.25
Z	1,050	1,350	300	5	60	1.25

14.3.4.6 Model Validation

Extensive visual and statistical validation of the grade estimates was completed, including:

- Review of the block estimate and the composite data in cross-section, long-section and plan views.
- Comparison of composite grades and block model grades broken down into northing, easting and/or elevation zones.
- Comparison of the mean grade of the contributing composites versus the mean grade of the estimate.
- Comparison with reconciled production figures.

The validation indicates that the Mineral Resource model replicates the source input data well in regions of higher density drilling. Swath plots were created and show that for the regions of domains where data density is lower, smoothing is evident; however, the estimate is considered appropriate as the trends in the data are adequately reproduced.

14.3.4.7 Mineral Resource Classification

The Mineral Resource has been defined using criteria determined during the validation of the grade estimates, with detailed consideration of the classification guidelines. The deposit has been classified as Indicated or Inferred Mineral Resource based on a combination of the following quantitative and qualitative criteria:

- Adequate levels of drilling and sample density. All material within the defined drilled-out portion of the resource was classified as Indicated.
- Adequate levels of QA/QC.
- An area was classified as Inferred where the data density was sufficient to imply, but too sparse to confirm, geological and grade continuity. Inferred material is not interpolated or extrapolated past 40 m grid spacing in all directions past the last data point.

Some areas of the resource were not classified or included in the reported totals but represent areas of mineral potential. These areas were defined as follows:

- Any extrapolated material or any lode with fewer than 30 samples;
- All mineralised zones intersected by a single drill section; and
- Lodes estimated entirely with RAB or Air Core drill holes, around clearly defined mineralised zones, but themselves not clearly definable by either grade or geological continuity.

The Fairplay Main Mineral Resource was classified in accordance with the JORC Code 2012 guidelines. A reconciliation of this reporting and the CIM Definition Standards (2014) by the Qualified Person shows no material differences.

14.3.4.8 Mineral Resource Reporting

CIM Definition Standards for Mineral Resources and Mineral Reserves (May 2014) defines a mineral resource as:

"A Mineral Resource is a concentration or occurrence of solid material of economic interest in or on the Earth's crust in such form, grade or quality and quantity that there are reasonable prospects for eventual economic extraction.

To meet the 'reasonable prospects for eventual economic extraction' requirement, the resource model was constrained inside an optimised pit shell using a gold price of US\$1,700/oz with a USD:AUD exchange rate of 0.70.

The Fairplay Main Mineral Resource is summarised in Table 14-20.

Table 14-20 Fairplay Main Open Pit Mineral Resource

MRE Summary	Measured			Indicated			Measured & Indicated			Inferred		
	kt	g/t	koz	kt	g/t	koz	kt	g/t	koz	kt	g/t	koz
Fairplay Main	0	0.0	0	368	2.0	24	368	2.0	24	1.8	1.0	0.06

- 1) Mineral Resources that are not Mineral Reserves do not have demonstrated economic viability. There is no certainty that all or any part of the Mineral Resources estimated will be converted into Mineral Reserves.
- 2) The Measured and Indicated Mineral Resources are inclusive of those Mineral Resources modified to produce Mineral Reserves.

- 3) The Mineral Resource estimates include Inferred Mineral Resources that are normally considered too speculative geologically to have economic considerations applied to them that would enable them to be categorized as Mineral Reserves. There is also no certainty that Inferred Mineral Resources will be converted to Measured and Indicated categories through further drilling, or into Mineral Reserves once economic considerations are applied.
- 4) The Gold Mineral Resources are estimated using a long-term gold price of US\$1,700/oz with a USD:AUD exchange rate of 0.70.
- 5) The Gold Mineral Resource was reported using a 0.5 g/t cut-off grade taking into account variable operational costs associated with the Higginsville Open Pits.
- 6) Classification is according to JORC Code and CIM Definition Standards Mineral Resource classification categories.
- 7) The Mineral Resource is depleted for mining to September 30, 2023.
- 8) To best represent 'reasonable prospects of eventual economic extraction', the Mineral Resource for open pits has been reported within an optimized pit shells at A\$2,429/oz (US\$1,700/oz).
- 9) Mineral Resource tonnage and contained metal have been rounded to reflect the accuracy of the estimate, and numbers may not add due to rounding.
- 10) Gold Mineral Resource estimates were prepared under the supervision of Qualified Person S. Devlin, FAusIMM (Chief Geological Officer, Karora Resources).

14.3.5 Two Boys

14.3.5.1 Summary

The Two Boys deposit lies 800 m south of the Higginsville Mill and is part of the Line-of-Lode, the series of deposits along a roughly north-south trend around the Trident deposit. The Line-of-Lode trend is bounded by the Poseidon Thrust to the east and Thrust A to the west.

The bedrock geology comprises ultramafic and sedimentary-dominated units metamorphosed under amphibolite to greenschist facies conditions.

The Two Boys area has three major rock types which strike north-south and dip approximately 45° east. The mineralisation is hosted in a medium grained weakly differentiated gabbro approximately 130 m at its widest point. The footwall consists of a tremolitic ultramafic and the hangingwall is a high MgO basalt unconformably overlain by a sedimentary package (which lies outside of the open pit boundary to the east).

The sequence is cut by a low angle shear zone formed as a low angle thrust, known as the Two Boy Shear Zone (TBSZ). The TBSZ strikes towards the east and overall dips approximate 30° towards the north-northeast.

The mineralisation at Two Boys is hosted within the TBSZ associated with quartz veining, shear selvage and wall rock alteration. Intense biotite-chlorite-carbonate-sericite-pyrite alteration occurs over several metres into the wall rock from the quartz vein. Gold is often visible occurring as coarse gold grains up to several millimetres in diameter and often occurring with pyrite, arsenopyrite and galena.

Two revised models have been estimated since the 2020 reported estimate, the first in April 2021 and the second in February 2022. These revisions were due to completion of various drill campaigns.

The deposit represents both open pit and underground potential and was mined by Karora using both mining methods. Swagman open pit was mined between August 2021 to November 2021 and underground mining was completed between May 2021 and February 2023. The Mineral Resource at the Two Boys deposit has been reported using a 0.5 g/t Au cut-off within a US\$1,700/oz pit shell, and at 1.3 g/t Au cut-off below this pit shell.

14.3.5.2 Drilling and Sample Data

The deposit has been drilled by several companies using predominantly surface RC and diamond holes. Historically, RAB, AC and auger holes were completed.

The database used in the current estimate was exported from the Karora server on January 21, 2022. It includes records for 4,068 drill holes for 162,894 drill metres. A total of 10 unique hole types have been recorded with completion dates ranging from 2007 to present. Blank entries within the date field indicate unknown completion dates from previous owners (pre-2004).

A total of 608 drill holes intersected the lodes at Two Boys for a total of 3,193 intersection metres. This includes records for 15 diamond holes, 578 RC holes, and 15 RCD holes.

The Two Boys deposit occurs on the Line-of-Lode trend which includes the Trident and Poseidon deposits which have been mined by previous owners. The density values used at those deposits for similar lithologies have been applied to the Two Boys model.

The bulk density values were assigned to the block model as average values within each material type, and these are summarised in Table 14-21.

Table 14-21 Bulk density values assigned in the block model

Material	Density (t/m ³)
Backfill/Dump	1.4
Oxide	1.8
Transitional	2.4
Fresh	2.89

14.3.5.3 Modelling Domains

The Two Boys mineralisation has been interpreted using a 0.5 g/t Au cut-off to define anomalous mineralisation.

The interpreted sectional outlines were manually triangulated to form wireframes using the downhole gold grades in association with the logged lithology and vein occurrence. To form ends to the wireframes, the end section strings were copied to a position 10 m from the section, or midway to the next section, and adjusted to match the dip, strike and plunge of the zone. Lodes were extended at depth to a distance that was half the distance to the previous up-dip mineralised intersection (maximum of 40 m).

A minimum downhole length of 2 m was used with no edge dilution. To allow for continuity, up to 2 m of internal dilution was included in some intersections. In situations where the structural continuity of the lode was interpreted to persist, lower grade assays were included.

The wireframes were set as solids after being validated using GEOVIA Surpac™ V7.4.

The BOCO and TOFR surfaces were generated to cover the entire strike length of the Two Boys deposit. Surfaces were updated in 2015 and were based on geology logging of all available drill data.

A total of 12 mineralised lodes were interpreted across the deposit. The western lodes are defined by Domains 3 to 7 and collectively form the Swagman and western lodes. These strike north-south and dip to the east (4° at the southern end steepening to 45° toward the north). The Main Lode (Domain 1) occurs within the TBSZ and dips to the north at approximately 25°. The

eastern portion of this lode has been extensively mined using UG stopping methods. Lode 2 (Eastern Lode) occurs at the east of the deposit. This lode is confined to an 80 m width and dips at approximately 20° to the north.

Mineralised lodges are shown in Figure 14-21 and Figure 14-22.

Figure 14-21 Plan view of Two Boys mineralisation interpretation

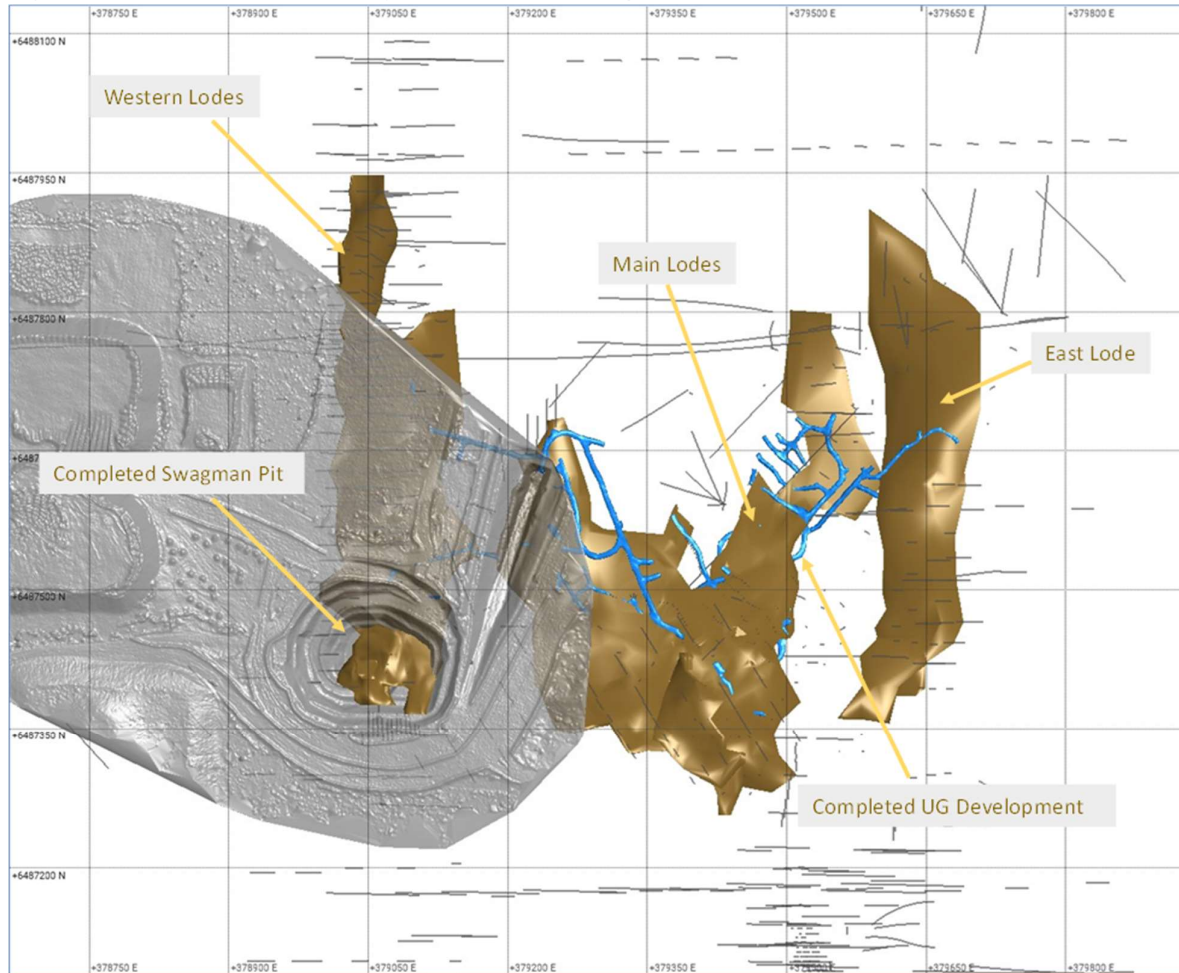
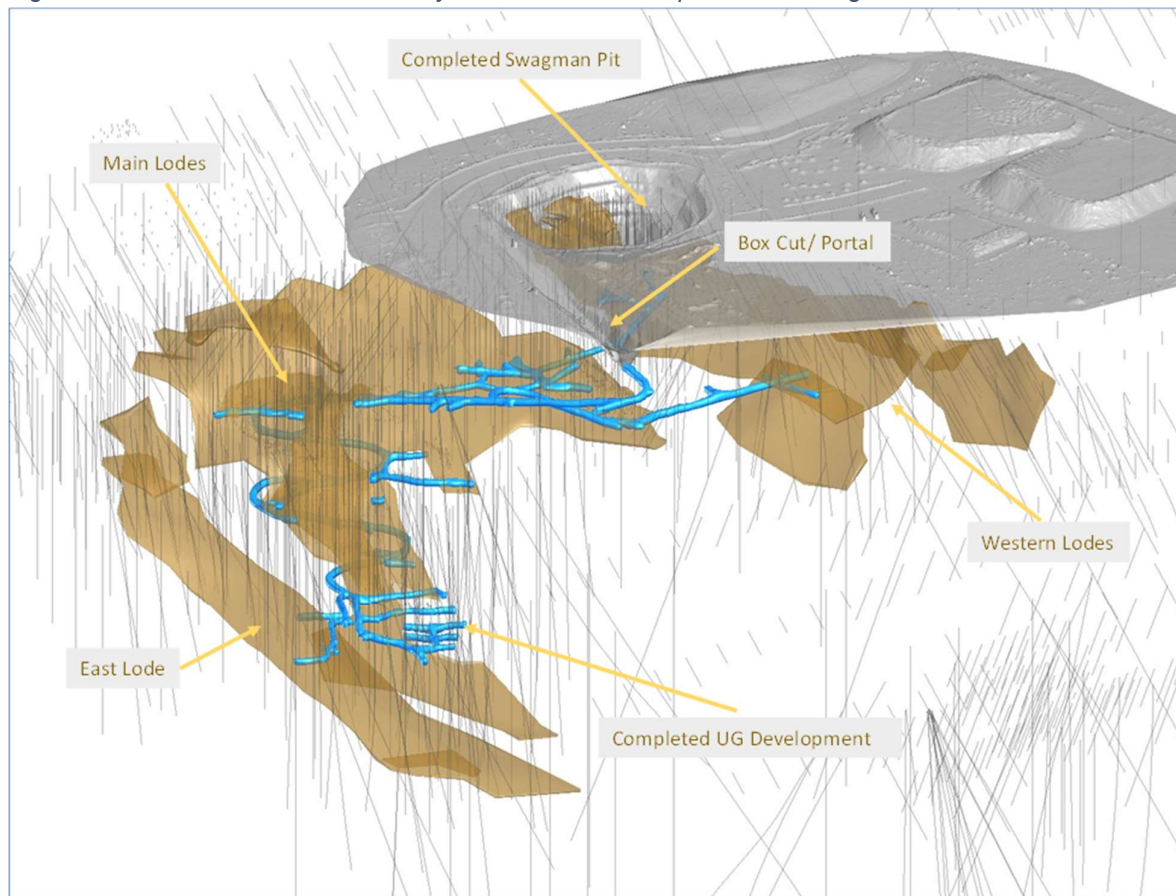

Figure 14-22 Isometric view of Two Boys mineralisation interpretation looking southwest



14.3.5.4 Statistical Analysis and Compositing

The wireframes of the mineralised lodes were used to code the drill hole intersection into the database to allow identification of the resource intersections. GEOVIA Surpac™ was then used to extract downhole composites within the different resource domains. Holes were composited to 1 m with a minimum residual of 0.25 m. The composites were checked for spatial correlation with the objects, the location of the rejected composites, and zero composite values. Individual composite files were created for each of the domains in the wireframe models.

A CV greater than 1.5 generally indicates that the data do not have a normal distribution. As the CV increases, so do the positive skew and the number of high outliers. To assist in the selection of appropriate top-cuts, the composite data were loaded into Supervisor software and histograms and probability plots were generated for each domain. Each domain was analysed individually, reviewing percentile charts, log probability plots and histograms to determine any points of distribution decay or disintegration. Analysis of each domain showed that six lodes required grade capping. These varied from 12 g/t to 160 g/t. A summary of Au statistics for individual lodes is tabulated in Table 14-22 and the histogram and log-probability plots for the main domain are shown in Figure 14-23.

Table 14-22 Summary statistics for Two Boys composites

Domain	Count	Min	Max	Mean	CV	Top-Cut			No. Comps Top-Cut
						Value	Mean	CV	
1	998	0.01	124.90	2.09	3.1	40	1.92	2.2	6
2	244	0.04	46.70	2.71	2.1	22	2.48	1.7	4
3	1,120	0.01	223.28	2.93	3.5	60	2.63	2.4	4
4	366	0.01	22.90	1.61	1.5	12	1.54	1.3	6
5	41	0.04	4.50	0.95	1.0	-	0.95	1.0	-
6	36	0.01	4.80	0.84	1.1	-	0.84	1.1	-
7	57	0.01	10.54	1.37	1.3	-	1.37	1.3	-
8	145	0.01	11.50	1.14	1.2	-	1.14	1.2	-
9	11	0.04	28.22	7.56	1.1	-	7.56	1.1	-
10	4	2.47	4.51	3.27	0.3	-	3.27	0.3	-
11	49	0.12	3.19	0.98	0.7	-	0.98	0.7	-
101	110	0.19	479.50	35.09	1.9	160	29.79	1.5	7

Figure 14-23 Histogram and log probability plots for Main Domain 1

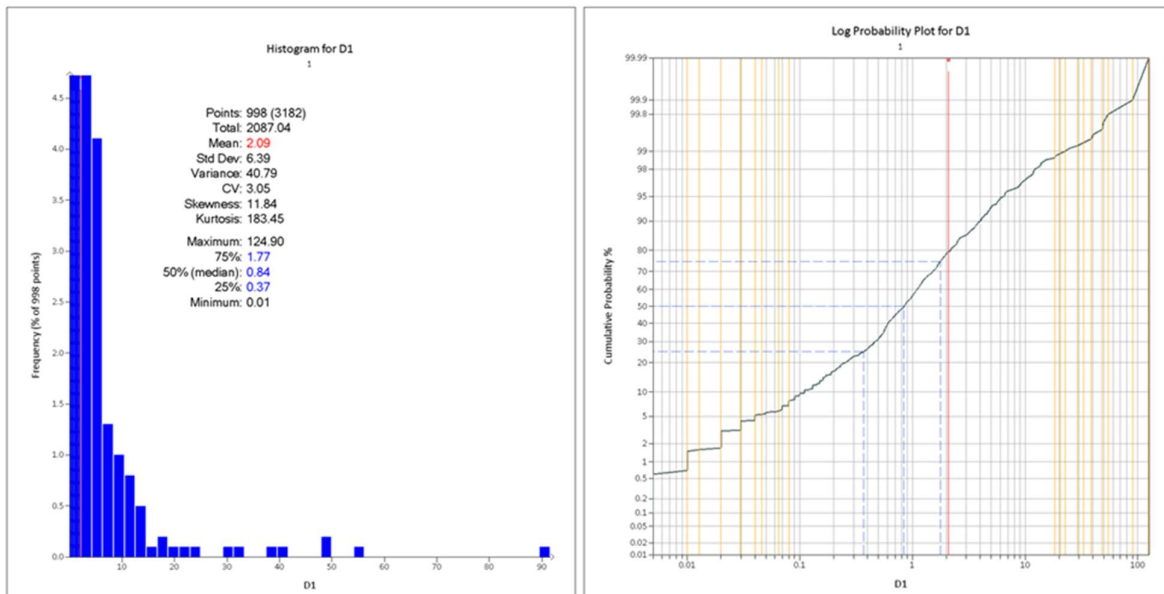

14.3.5.5 Variography

Understanding the grade continuity and determining its extent and orientation is achieved through interpreting and modelling the experimental variogram. The experimental variogram requires sufficient sample data to provide a reliable measure of the grade continuity. Relevant lodes were modelled using Supervisor software using a log transformation.

A two-structured nested spherical model was found to model the experimental variograms reasonably well. The downhole variogram provides the best estimate of the true nugget value which was generally low to moderate for Au (from 0.11 to 0.42). Variogram parameters were applied to the minor lodes where there were insufficient samples to model.

The variogram model for Domain 1 is shown in Figure 14-24 and the interpolation parameters are tabulated in Table 14-23.

Figure 14-24 Variogram models for Domain 1

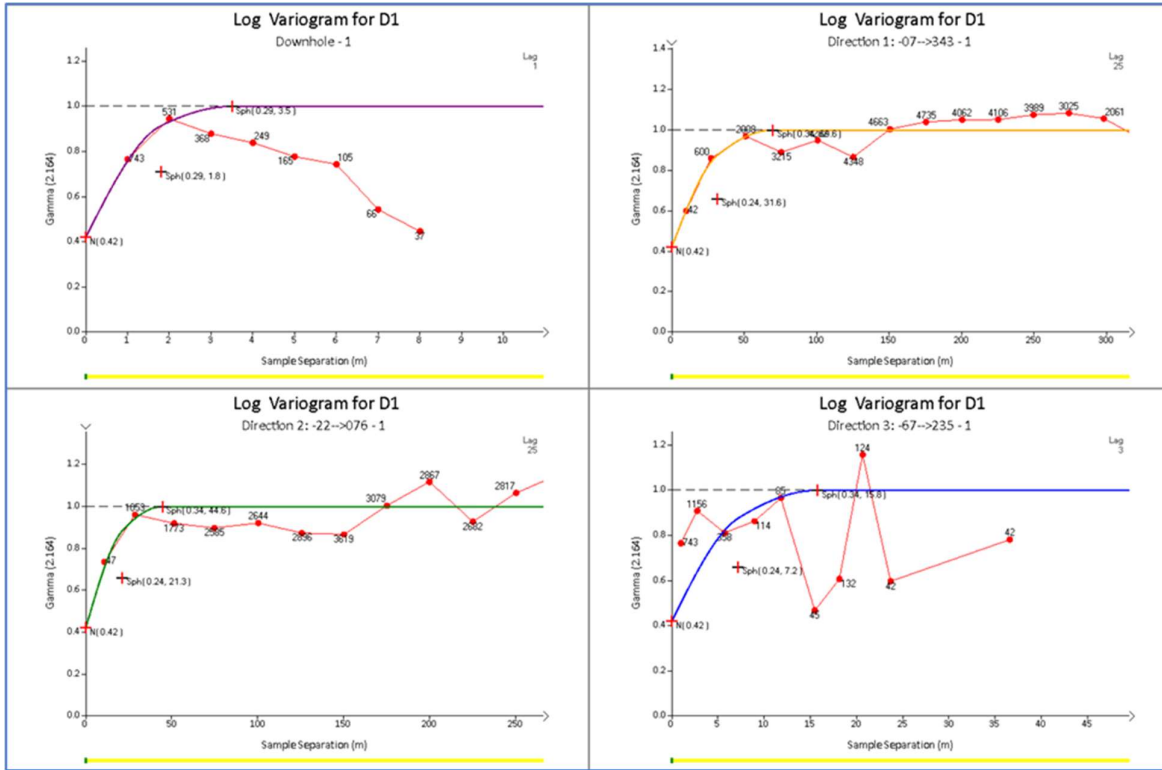

Table 14-23 Variogram parameters summary for Au

Domain	c0	Spherical 1				Spherical 2			
		c1	a1	semi1	minor1	c2	a2	semi2	minor2
1	0.42	0.24	31.6	1.5	4.4	0.34	69.6	1.6	4.4
2	0.32	0.14	28.9	1.0	15.2	0.54	69.3	1.3	11.4
3STH	0.5	0.16	14.0	1.6	4.7	0.34	28.0	2.1	2.8
3NTH	0.11	0.37	71.0	1.4	8.9	0.52	175.0	2.0	6.0
4	0.25	0.35	39.7	1.8	14.7	0.4	68.2	2.1	6.6
8	0.25	0.36	48.9	1.6	27	0.39	55.6	1.3	19
101	0.38	0.22	30.1	2	3.2	0.4	55.7	1.9	3.1

14.3.5.6 Block Model and Grade Estimation

A block model was created using GEOVIA Surpac™ to encompass the full extent of the deposit. A parent block size of 5 m NS x 5 m EW x 2.5 m vertical with sub-blocking to 2.5 m x 1.25 m x 1.25 m was used. The selected parent block size was based on the results of a kriging neighbourhood analysis (KNA) and is comparable to 50% of the average closest drill hole spacing, while the small sub-block size in the east-west direction was necessary to provide sufficient resolution to the block model.

Ordinary kriging (OK) was used for the grade interpolation as it allowed the measured spatial continuity to be incorporated into the estimate and results in a degree of smoothing which is

appropriate for the disseminated nature of the mineralisation. The wireframes were used as a hard boundary for the grade estimation of each domain. That is, only grades inside each lode were used to interpolate the blocks inside the lode.

An 'ellipsoid' search orientated to reflect the geometry of the individual lodges was used to select data for interpolation. The search ellipse was based on the kriging parameters but adjusted to reflect the local changes in each of the minor lodges.

Three estimation passes were used for the interpolations. A first pass search radius ranging from 15 m to 50 m (dependent on lode) was used based on the experimental variogram ranges. Search distances were doubled for each successive pass. A minimum of 6 to 10 samples was required in the first pass and this was reduced to 4 to 6 and then 2 to 4 for each successive pass. A limit of four samples per drill hole was imposed.

14.3.5.7 Model Validation

The following three-step process was used to validate the estimate through the entire deposit:

- A visual assessment was completed by slicing sections through the block model in positions coincident with drilling.
- A quantitative assessment was completed by comparing the average grades of the composite file input against the block model output for all the lodges.
- For the main domains, trend swath plots were generated in various orientations across strike, along strike and at elevation.

The validation indicates that the Mineral Resource model replicates the source input data well in regions of higher density drilling. Smoothing is evident in domains with limited input data; however, the estimate is considered appropriate as the trends in the data are adequately reproduced.

14.3.5.8 Mineral Resource Classification

The Two Boys Mineral Resource was classified in accordance with the JORC Code 2012 guidelines. A reconciliation of this reporting and the CIM Definition Standards (2014) by the Qualified Person shows no material differences.

The deposits have been classified as Measured, Indicated or Inferred Mineral Resource based on a combination of quantitative and qualitative criteria which included geological continuity and confidence in volume models, data quality, sample spacing, lode continuity and estimation parameters.

The Measured category has been applied to the southern part of the western lodges where grade control drilling has been completed at 10 m by 5 m spacing and the continuity of mineralisation is robust.

The Indicated portion of the Mineral Resource was defined across the main lodges through areas that had generally been filled in the first estimation pass and were defined by RC and diamond holes on spacings of 20 m or less. Digitised strings were used to form regular shapes to code these areas.

The minor lodges and the down dip extents of the main lodges were classified as Inferred Mineral Resource.

The block model coloured by classification is shown in Figure 14-25.

Figure 14-25 Two Boys model classification – isometric view looking southwest

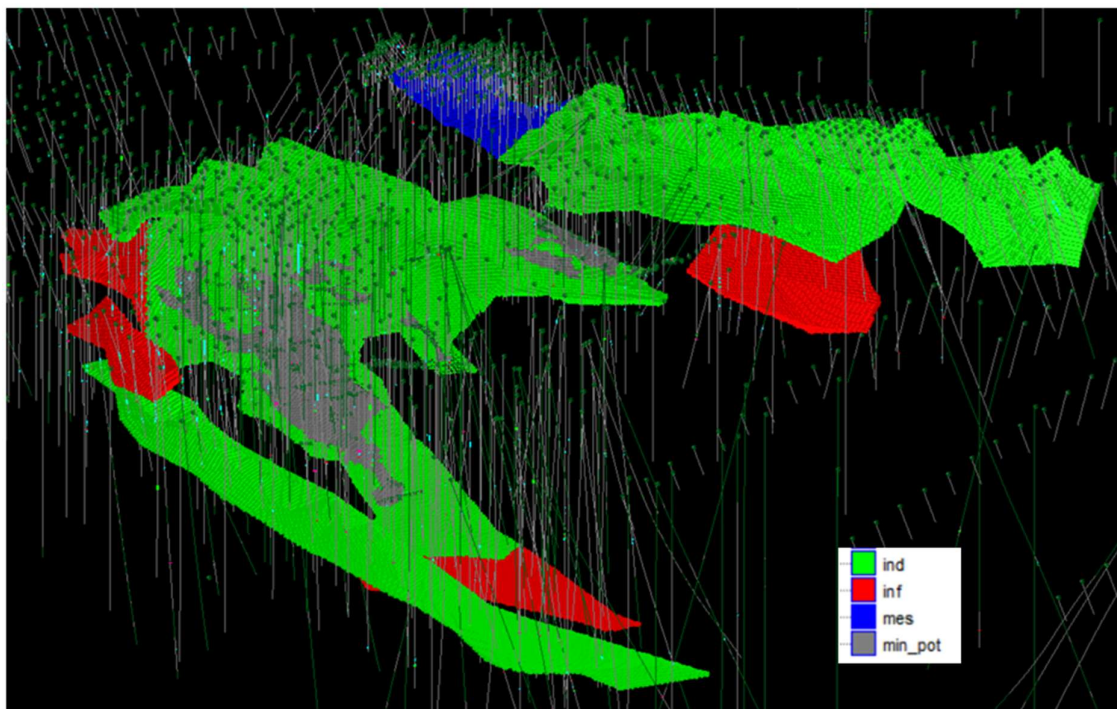

14.3.5.9 Mineral Resource Statement

The Mineral Resource Statement presented herein sets out the Gold Mineral Resource estimate prepared in accordance with the Canadian Securities Administrators' National Instrument 43-101 and Form 43-101F. The Mineral Resource estimate as set out in Table 14-24 is effective as of September 30, 2023. The Mineral Resource at the Two Boys gold deposit has been reported using 0.5 g/t Au cut-off for open pit material and 1.3 g/t Au for underground material and has been depleted for open pit and underground mining.

Table 14-24 Two Boys Gold Deposit September 2023 Mineral Resource Estimate

MRE Summary	Measured			Indicated			Measured & Indicated			Inferred		
	kt	g/t	koz	kt	g/t	koz	kt	g/t	koz	kt	g/t	koz
Two Boys	23	1.6	1	1,147	2.3	86	1,170	2.3	87	185.2	2.8	16.49

- 1) Mineral Resources that are not Mineral Reserves do not have demonstrated economic viability. There is no certainty that all or any part of the Mineral Resources estimated will be converted into Mineral Reserves.
- 2) The Measured and Indicated Mineral Resources are inclusive of those Mineral Resources modified to produce Mineral Reserves.
- 3) The Mineral Resource estimates include Inferred Mineral Resources that are normally considered too speculative geologically to have economic considerations applied to them that would enable them to be categorized as Mineral Reserves. There is also no certainty that Inferred Mineral Resources will be converted to Measured and Indicated categories through further drilling, or into Mineral Reserves once economic considerations are applied.
- 4) The Gold Mineral Resources are estimated using a long-term gold price of US\$1,700/oz with a USD:AUD exchange rate of 0.70.
- 5) The Gold Mineral Resource was reported using a 0.5 g/t cut-off grade within an optimised pit shell and a 1.3g/t cut-off grade below this shell, taking into account variable operational costs associated with the Higginsville Open Pit and Underground operations.
- 6) Classification is according to JORC Code and CIM Definition Standards Mineral Resource classification categories.

- 7) The Mineral Resource is depleted for mining to September 30, 2023.
- 8) To best represent 'reasonable prospects of eventual economic extraction', the Mineral Resource for open pits has been reported within an optimized pit shells at A\$2,429/oz (US\$1,700/oz).
- 9) Mineral Resource tonnage and contained metal have been rounded to reflect the accuracy of the estimate, and numbers may not add due to rounding.
- 10) Gold Mineral Resource estimates were prepared under the supervision of Qualified Person S. Devlin, FAusIMM (Chief Geological Officer, Karora Resources).

14.3.6 Pioneer

14.3.6.1 Summary

The Pioneer Deposit is located approximately 12 km southwest of the Higginsville Mill and can be accessed via unsealed track from the mill or via the Coolgardie-Esperance Highway and then unsealed track.

The Pioneer Deposit is dominated by fine grained siliceous sediments (Black Flag Beds) located to the west with ultramafics located to the east. Narrow interflow cherty sediments are common within the ultramafics.

The Pioneer Thrust is the dominant structure and has caused the older ultramafics in the east to unconformably overlie the Black Flag sediments to the west, with the contact dipping at approximately 70° to 80° to the east. This is a major structure that can be traced on a regional scale to both the north and south.

The steeply east dipping, NNE trending Pioneer Shear, lies approximately 30 m east of the Pioneer Thrust and hosts the Pioneer Deposit. Brittle-ductile deformation within this structure has created dilatational sites preferential for gold mineralising fluids.

The Pioneer area is interpreted as moderately east dipping domains between the vertical shears. The Pioneer Shear displaces the mineralisation and is considered the boundary between the southern and northern areas.

The mineralisation is hosted within a mafic package comprised mainly of silicified basalt with narrow, cherty interflow sediments. The moderately east dipping mineralisation is bounded by steeply east dipping, NNW trending regional shears. The gold is associated with disseminated pyrite in the host rocks, quartz veining is rare. Sub-horizontal mineralisation toward the south of the deposit has been interpreted as a supergene horizon.

An updated Mineral Resource estimate was completed for the Pioneer gold deposit located within the Higginsville Gold Operations area. The previous estimate was completed in April 2023 by Karora. This update incorporates 227 drill holes (including 209 GC holes) that were completed since April 2023.

The Pioneer Mineral Resource estimate has been completed using historical and recent drill results of predominantly reverse circulation drilling methods. Drilling extends to a vertical depth of approximately 260 m and the mineralisation has been modelled from surface (at 291 mRL) to a depth of approximately 210 m below surface.

14.3.6.2 Drilling and Sample Data

The deposit has been drilled by several companies using predominantly surface RC and diamond holes. Historically, RAB and AC holes were completed.

The database used in the current estimate was exported from the Karora server on September 19, 2023.

A total of 227 drill holes were completed at the deposit since the April model update. This total includes 209 GC holes completed within Stage 1 and 2 pits. A summary of drilling at the deposit is shown in Table 14-25. The most recent model update incorporated 354 RC holes, 12 diamond holes and 4 RC holes with diamond tails for a total of 370 holes and 3,700 intersection metres.

Table 14-25 Pioneer drill hole summary

HoleType	Database Export		In Resource	
	Holes	Metres	Holes	Metres
AC	170	7,690		
DDH	18	2,160	12	199
RAB	108	4,372		
RC	607	38,783	354	3,442
RC/DDH	5	681	4	59
Total	908	53,686	370	3,700

Aircore and RAB holes were excluded from the estimate. In addition, four other holes were excluded as listed in Table 14-26. The diamond hole was excluded as it was drilled down dip of the main lode on the footwall contact and so reported intermittent grade downhole. The section is adequately covered by five RC holes drilled at a preferred orientation. The three RC holes were excluded as the gold grades conflicted with more recent drilling.

Table 14-26 Drill holes excluded from the Resource Estimate

Hole ID	Date Drilled	HoleType	Max Depth (m)	Company
PORR0003	08-May-13	RC	96	AVO
PC0005	08-May-95	RC	70	Resolute
PORD0001	23-Nov-19	DDH	130.1	RNC
PORB03	17-Oct-19	RC	96	RNC

14.3.6.3 Modelling Domains

The Pioneer mineralisation has been interpreted using a 0.4 g/t Au cut-off to define anomalous mineralisation.

The interpreted sectional outlines were manually triangulated to form wireframes using the downhole gold grades in association with the logged lithology and vein occurrence. To form ends to the wireframes, the end section strings were copied to a position midway to the next section, and adjusted to match the dip, strike and plunge of the zone. Lodes were extended at depth to a distance that was half the distance to the previous up-dip mineralised intersection (maximum of 40 m).

A minimum downhole length of 2 m was used with no edge dilution. To allow for continuity, up to 2 m of internal dilution was included in some intersections. In situations where the structural continuity of the lode was interpreted to persist, lower grade assays were included.

The wireframes were set as solids after being validated using GEOVIA Surpac™ V7.4.

The weathering surfaces representing BOCO and TOFR were updated with the new drilling. Surfaces were defined by using a combination of logged attributes such as lithology, lithology oxidation and regolith, in combination with logged event.

The Pioneer gold envelopes have been modelled into 24 individual domains. The main lode is defined by Domain 1 and includes two small internal high-grade lodes (Domains 101 and 102). The lodes strike north-south and dip moderately to the east at an average dip of 40°. The main lode varies in true thickness from 2 m to 15 m.

A long-section image is shown in Figure 14-26 and shows the September 2023 EOM pit survey. A plan view of the interpreted mineralisation is shown in Figure 14-27 where the main lodes have been labelled.

Figure 14-26 Long-section view looking west of Pioneer mineralisation interpretation – main lodes labelled

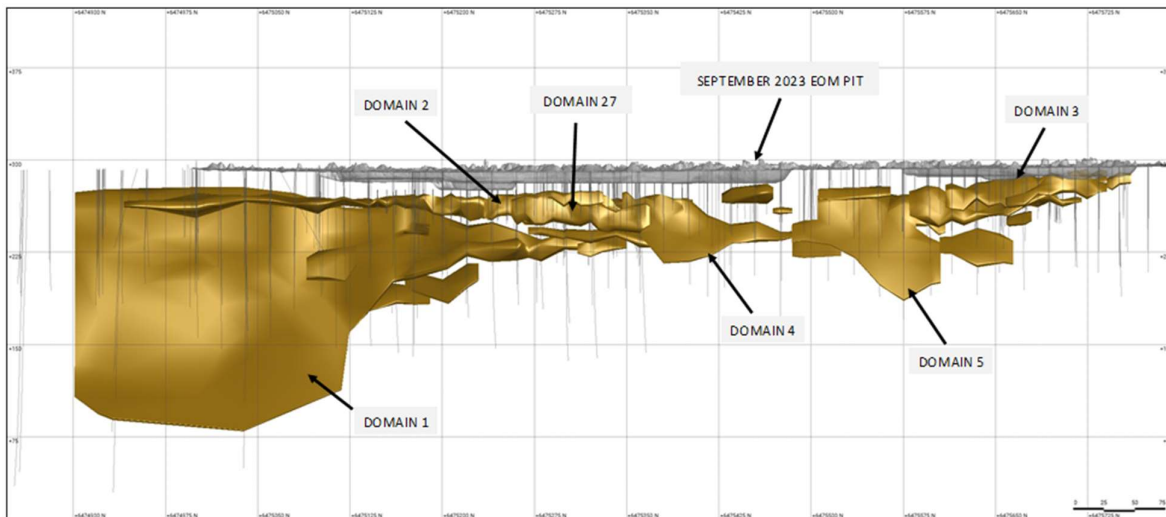
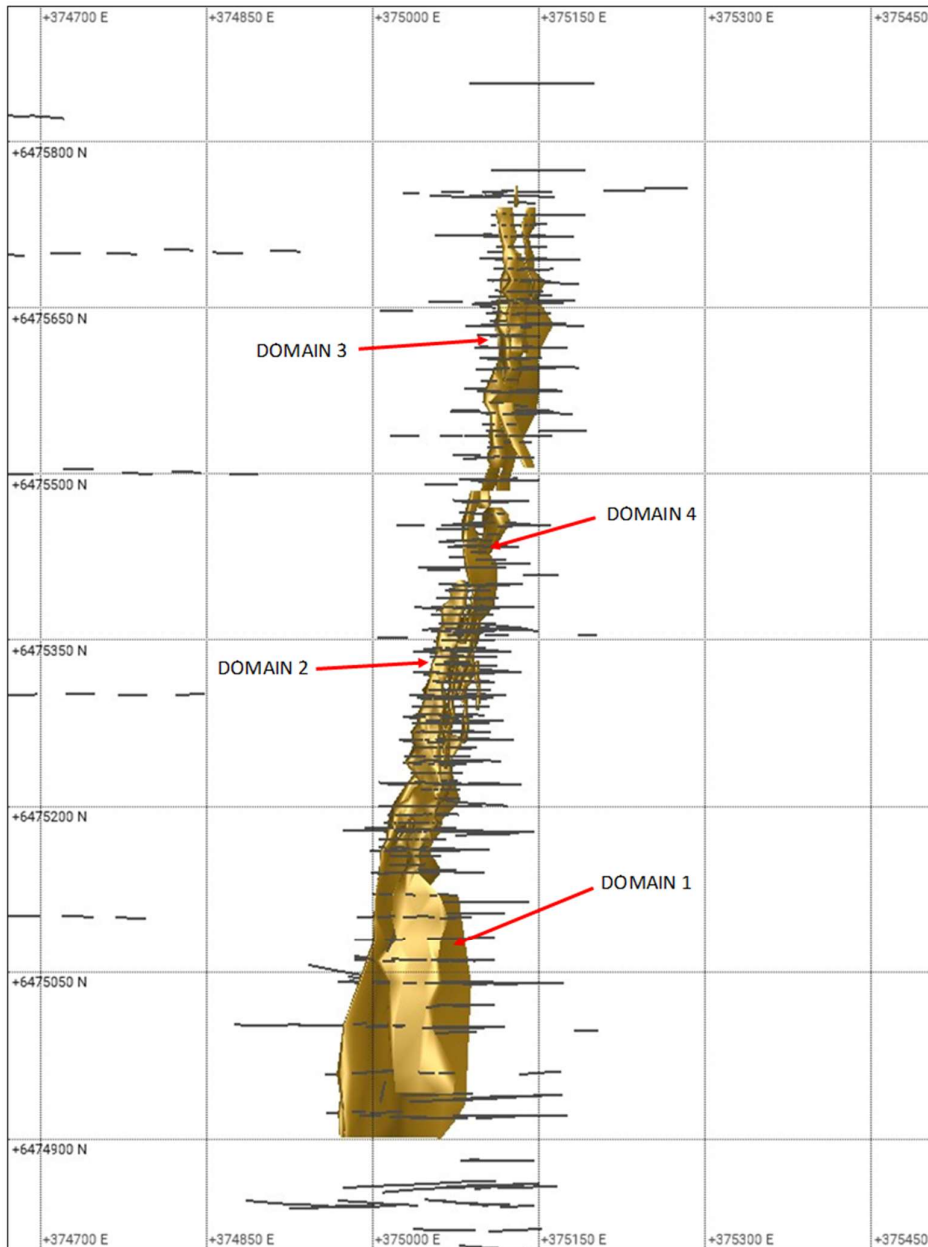

Figure 14-27 Plan view of Pioneer mineralisation interpretation – main lodes labelled



14.3.6.4 Statistical Analysis and Compositing

The wireframes of the mineralised lodes were used to code the drill hole intersection into the database to allow identification of the resource intersections. GEOVIA Surpac™ was then used to extract downhole composites within the different resource domains. Holes were composited to 1 m with a minimum of 0.25 m. The composites were checked for spatial correlation with the objects, the location of the rejected composites, and zero composite values. Individual composite files were created for each of the domains in the wireframe models.

A CV greater than 1.5 generally indicates that the data do not have a normal distribution. As the CV increases, so do the positive skew and the number of high outliers. To assist in the selection of appropriate top-cuts, the composite data were loaded into Supervisor software and histograms and probability plots were generated for each domain. Each domain was analysed individually, reviewing percentile charts, log probability plots and histograms to determine any points of distribution decay or disintegration. Analysis of each domain showed that eight lodes required capping and these values ranged from 5 g/t to 20 g/t. A summary of Au statistics for individual lodes is shown in Table 14-27.

Table 14-27 Pioneer Deposit summary statistics

Domain	Count	Min	Max	Mean	CV	Top-Cut			No. Comps Top-Cut
						Value	Mean	CV	
1	877	0.01	17.10	1.63	1.03	-	-	-	-
2	1,268	0.01	49.70	1.54	1.512	-	-	-	-
3	628	0.01	42.15	2.30	1.497	20	2.3	1.36	2
4	171	0.07	14.10	1.42	1.294	8	1.3	1.08	3
5	216	0.01	10.13	1.31	1.033	-	-	-	-
6	5	0.02	6.47	2.13	1.113	-	-	-	-
7	55	0.01	47.70	2.68	2.796	10	1.6	1.44	2
8	12	0.42	19.30	4.26	1.215	10	3.5	0.91	1
9	334	0.01	5.15	1.00	0.734	-	-	-	-
10	27	0.05	7.01	2.02	0.886	-	-	-	-
11	68	0.29	13.30	3.49	0.868	-	-	-	-
12	11	0.18	5.70	1.16	1.298	-	-	-	-
13	29	0.05	3.76	0.93	0.986	-	-	-	-
14	15	0.40	7.57	2.45	0.8	-	-	-	-
15	17	0.12	16.30	3.69	1.332	10	3.0	1.09	2
16	13	0.25	3.42	1.37	0.707	-	-	-	-
19	40	0.02	8.68	1.03	1.303	5	0.9	0.91	1
21	76	0.01	17.20	1.96	1.43	8	1.8	1.15	4
22	10	0.16	3.44	1.35	0.789	-	-	-	-
23	15	0.03	3.64	1.20	0.984	-	-	-	-
24	8	0.30	3.61	1.33	0.886	-	-	-	-
27	289	0.02	9.62	2.07	0.986	-	-	-	-
101	52	1.84	12.00	5.05	0.334	-	-	-	-
102	68	0.80	17.50	5.40	0.695	-	-	-	-

14.3.6.5 Density

Previous Pioneer models had an assumed density coded to the oxide and transitional material due to no data measurements. The density was assigned to the fresh based on 42 measurements from four diamond holes. The analysis was summarised in the Technical Report produced by Trepanier Consultants (Barnes, 2020). Subsequent model updates assigned density in a similar manner due to no new measurements being completed. However, for the April 2023 update, the weathering surfaces were adjusted and nine metallurgical holes drilled with 83 measurements completed. The results are summarised in a Karora internal technical memorandum completed in May 2023.

The findings concluded that the density assigned to the transitional material should be adjusted from 2.5 t/m³ to 2.3 t/m³. Density values assigned to the September 2023 model update are summarised in Table 14-28.

Table 14-28 Density values applied at Pioneer

Material Type	Average Density (t/m ³)
Oxide	1.9
Transitional	2.3
Fresh	2.8

14.3.6.6 Variography

Understanding the grade continuity and determining its extent and orientation is achieved through interpreting and modelling the experimental variogram. The experimental variogram requires sufficient sample data to provide a reliable measure of the grade continuity. Relevant lodes were modelled using Supervisor software using a log transformation.

A two-structured nested spherical model was found to model the experimental variograms reasonably well. The downhole variogram provides the best estimate of the true nugget value which was generally low to moderate (from 0.11 to 0.31). Variogram parameters were applied to the minor lodes where there were insufficient samples to model.

The variogram model for Domain 1 is shown in Figure 14-28 and the interpolation parameters are summarized in Table 14-29.

Table 14-29 Pioneer Variogram parameters summary

Domain	c0	Spherical 1				Spherical 2			
		c1	a1	semi1	minor1	c2	a2	semi2	minor2
1	0.29	0.41	42	1.8	6.2	0.3	69	2.1	3.7
2	0.18	0.45	30	1.4	10	0.37	50	1.7	5
3	0.31	0.4	24	1.6	4.8	0.29	85	3.3	5.3
17	0.11	0.33	58.7	1.4	36.7	0.56	139.5	2.9	34.9

Figure 14-28 Variogram models for Domain 1

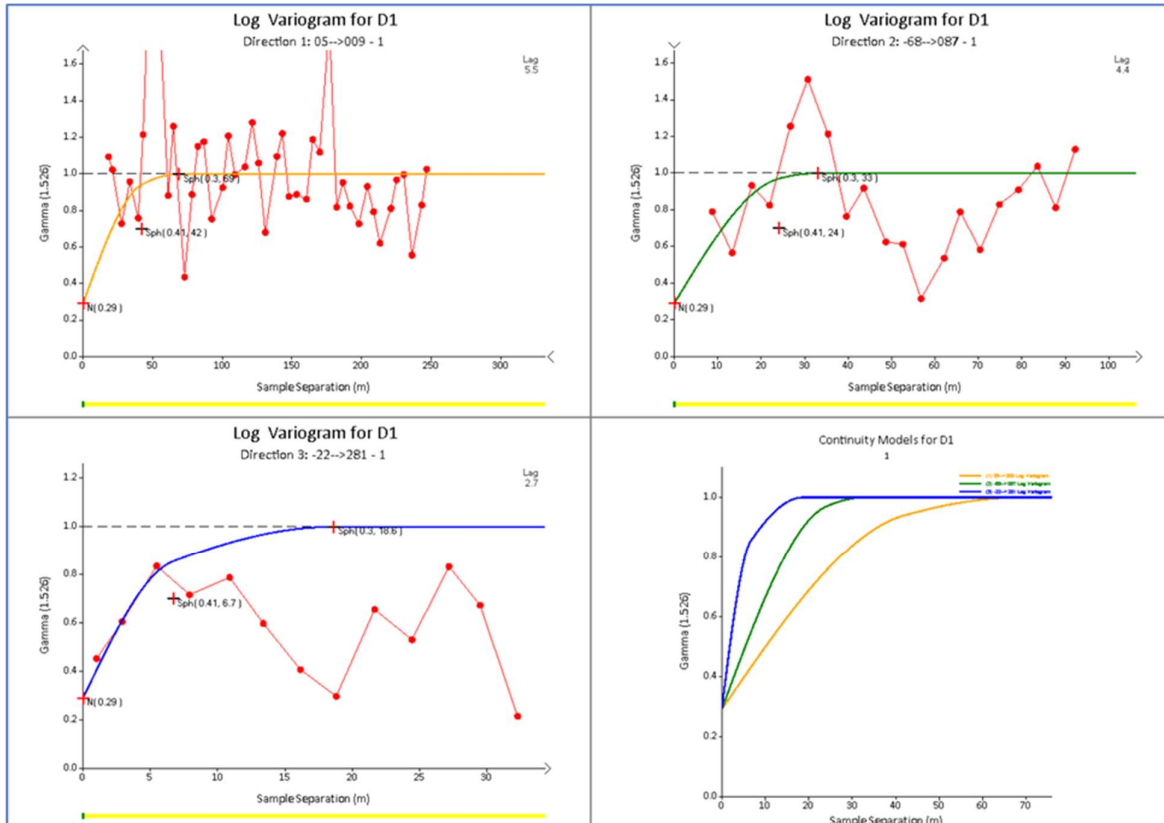

14.3.6.7 Block Model and Grade Estimation

A block model was created using GEOVIA Surpac™ to encompass the full extent of the deposit. A parent block size of 5 m NS x 2.5 m EW x 2.5 m vertical with sub-blocking to 2.5 m x 1.25 m x 1.25 m was used. The selected parent block size was based on the results of a kriging neighbourhood analysis (KNA) and is comparable to 50% of the average closest drill hole spacing, while the sub-block size was selected to provide sufficient resolution to the wireframe geometry represented in the block model.

Grade estimation was completed using ordinary kriging (OK) interpolation using GEOVIA Surpac™. The wireframes were used as a hard boundary for the grade estimation of each domain. That is, only grades inside each lode were used to interpolate the blocks inside the lode. An inverse distance cubed (ID³) interpolation was used as a check estimate.

An 'ellipsoid' search orientated to reflect the geometry of the individual lodges was used to select data for interpolation. The search ellipse was based on the kriging parameters but adjusted to reflect the local changes in each of the minor lodges.

Three estimation passes were used for the interpolations. A first pass search radius ranging from 15 m to 40 m was used based on experimental variogram ranges. Search distances were doubled for each successive pass. A minimum of 10 samples was required in the first pass, and this was reduced to 6 and then 2 for each successive pass. A limit of four samples per drill hole was imposed.

14.3.6.8 Model Validation

The following three-step process was used to validate the estimate through the entire deposit:

- A visual assessment was completed by slicing sections through the block model in positions coincident with drilling.
- A quantitative assessment was completed by comparing the average grades of the composite file input against the block model output for all the lodes.
- For the main domains, trend swath plots were generated in various orientations across strike, along strike and at elevation.

The validation indicates that the mineral resource model replicates the source input data well.

14.3.6.9 Mineral Resource Classification

The Pioneer Mineral Resource was classified in accordance with the JORC Code 2012 guidelines. A reconciliation of this reporting and the CIM Definition Standards (2014) by the Qualified Person shows no material differences.

The deposit has been classified as Measured, Indicated and Inferred Mineral Resource based on a combination of quantitative and qualitative criteria which included geological continuity and confidence in volume models, data quality, sample spacing, lode continuity and estimation parameters.

The Measured portion has been assigned to a 100 m strike of Domain 2 (within Stage 2 pit) which represents the west flat lying lode defined by 5 m spaced grade control drilling.

The Indicated portion of the Mineral Resource was defined across lodes that demonstrated reasonable grade continuity and lode geometry and were defined by drill holes spaced between 5 m and 20 m. These areas were predominantly estimated in the first pass. Digitised strings were used to form regular shapes to code these areas. The deeper drilling across the south of the deposit has resulted in the Indicated material being increased to beneath the current Stage 3 pit. The GC drilling through Stage 1 and 2 pits has highlighted the grade discontinuity and variability encountered at the local scale which prevents these areas from being classified at a higher level of confidence.

The remainder of the lodes were classified as Inferred Mineral Resource.

The block model coloured by classification is shown in Figure 14-29.

Figure 14-29 Pioneer block model coloured by resource classification – isometric view looking WNW

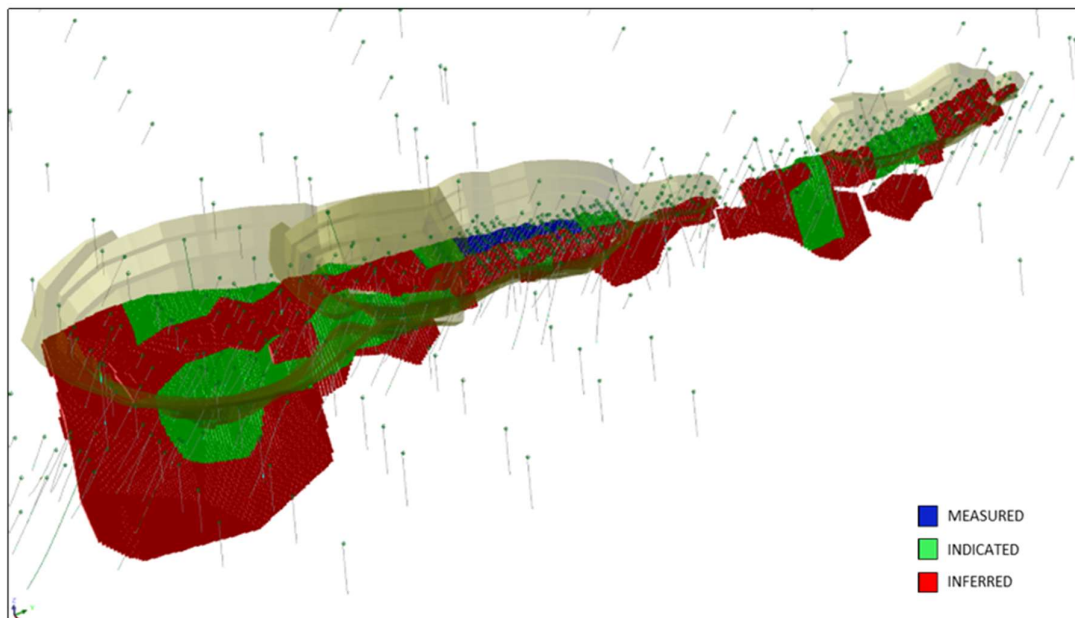

14.3.6.10 Mineral Resource Statement

The Mineral Resource Statement presented herein sets out the Gold Mineral Resource estimate prepared in accordance with the Canadian Securities Administrators' National Instrument 43-101 and Form 43-101F. The Mineral Resource estimate as set out in Table 14-30 is effective as of September 30, 2023. The Mineral Resource at the Pioneer gold deposit has been reported using 0.5 g/t Au cut-off for open pit material and has been depleted for open pit mining.

Table 14-30 Pioneer Depleted Mineral Resource using 0.5 g/t Au cut-off

MRE Summary	Measured			Indicated			Measured & Indicated			Inferred		
	kt	g/t	koz	kt	g/t	koz	kt	g/t	koz	kt	g/t	koz
Pioneer	48	1.6	2	574	2.1	38	622	2.0	41	412	1.5	20

- 1) Mineral Resources that are not Mineral Reserves do not have demonstrated economic viability. There is no certainty that all or any part of the Mineral Resources estimated will be converted into Mineral Reserves.
- 2) The Measured and Indicated Mineral Resources are inclusive of those Mineral Resources modified to produce Mineral Reserves.
- 3) The Mineral Resource estimates include Inferred Mineral Resources that are normally considered too speculative geologically to have economic considerations applied to them that would enable them to be categorized as Mineral Reserves. There is also no certainty that Inferred Mineral Resources will be converted to Measured and Indicated categories through further drilling, or into Mineral Reserves once economic considerations are applied.
- 4) The Gold Mineral Resources are estimated using a long-term gold price of US\$1,700/oz with a USD:AUD exchange rate of 0.70.
- 5) The Gold Mineral Resource was reported using a 0.5 g/t cut-off grade taking into account variable operational costs associated with the Higginsville Open Pits.
- 6) Classification is according to JORC Code and CIM Definition Standards Mineral Resource classification categories.
- 7) The Mineral Resource is depleted for mining to September 30, 2023.
- 8) To best represent 'reasonable prospects of eventual economic extraction', the Mineral Resource for open pits has been reported within an optimized pit shells at A\$2,429/oz (US\$1,700/oz).
- 9) Mineral Resource tonnage and contained metal have been rounded to reflect the accuracy of the estimate, and numbers may not add due to rounding.

- 10) Gold Mineral Resource estimates were prepared under the supervision of Qualified Person S. Devlin, FAusIMM (Chief Geological Officer, Karora Resources).

14.3.7 Mitchell Group

14.3.7.1 Summary

The Southern Paleochannel deposits are located approximately 3 km south of the Higginsville Mill and include the Graveyard, Aphrodites, Delta, and Mitchell paleochannel deposits. The deposits extend north-south over a 5 km strike length from 6,485,000 mN to 6,480,420 mN. The Mitchell deposit covers a strike length of 4 km and has been arbitrarily delineated into four zones labelled Mitchell 1 to 4 (Figure 14-30).

The Graveyard, Aphrodites and Delta deposits were mined to completion from 1990 to 1994 by Resolute Mining (Resolute).

The Mitchell Deposit was mined via open pit methods by Resolute. The pre-strip at Mitchell commenced late 1997 in the northern Mitchell 1 area. During 1998, ore was mined from Mitchell 1 whilst waste was mined from Mitchell 2, on 1 m flitches. Ore production switched to the southern part of Mitchell 2 in early 1999. In April 1999, mining was temporary suspended due to dwindling reserves and the temporary shutdown of the Chalice Mill. Mining recommenced in November 1999, before finally ceasing in January 2000 due to adversely wet weather conditions and the closure of the Chalice Mill. Mitchell produced a total of 17,480 oz from 226,795 t at an average grade of 2.40 g/t Au.

The Mitchell paleochannel deposit appears to directly overlie a major north-south trending shear (possibly the southern extension of the Poseidon Thrust). Underlying basement rocks at Mitchell 1 to 3 are dominated by high magnesium basalts which are often well foliated with significant amounts of biotite, silica, and carbonate hydrothermal alteration, suggesting that much of the anomalous gold at or near the base of the channel is derived by nearby remobilised primary mineralisation.

Mitchell 3 and 4 are at the lower reaches of the Mitchell South paleochannel, where the channel has shallow gradient margins and has flat to gently undulating bases over 200 m wide. The base of the channel truncates the lower saprolite in the underlying Archaean basement. The base of the channel is marked by a 0.3 m to 3 m thick quartzitic gravel lag, overlain by several upward fining cycles of reduced Eocene sedimentary sands, silts and clays.

Mitchell 4 lies within a magnetic low within highly magnetic komatiitic and high MgO basalts immediately west of the Poseidon Thrust. This basalt is intruded by dacitic porphyries, with much of the gold mineralisation directly overlying sheared ultramafic/porphyry contacts.

The Mitchell paleochannel deposit was modelled in June 2018 by Westgold using GEOVIA Surpac™.

Mitchell was well drilled before the 2018 model was constructed. Since the completion of that model, 11 aircore holes were drilled in 2020 by Karora. Four holes intercepted known mineralised lenses and confirmed the previous interpretation. Seven holes targeting a southern extension did not intercept significant mineralisation, confirming the previous interpreted southern limit of mineralisation.

Figure 14-30 Southern Paleochannel Deposits location plan

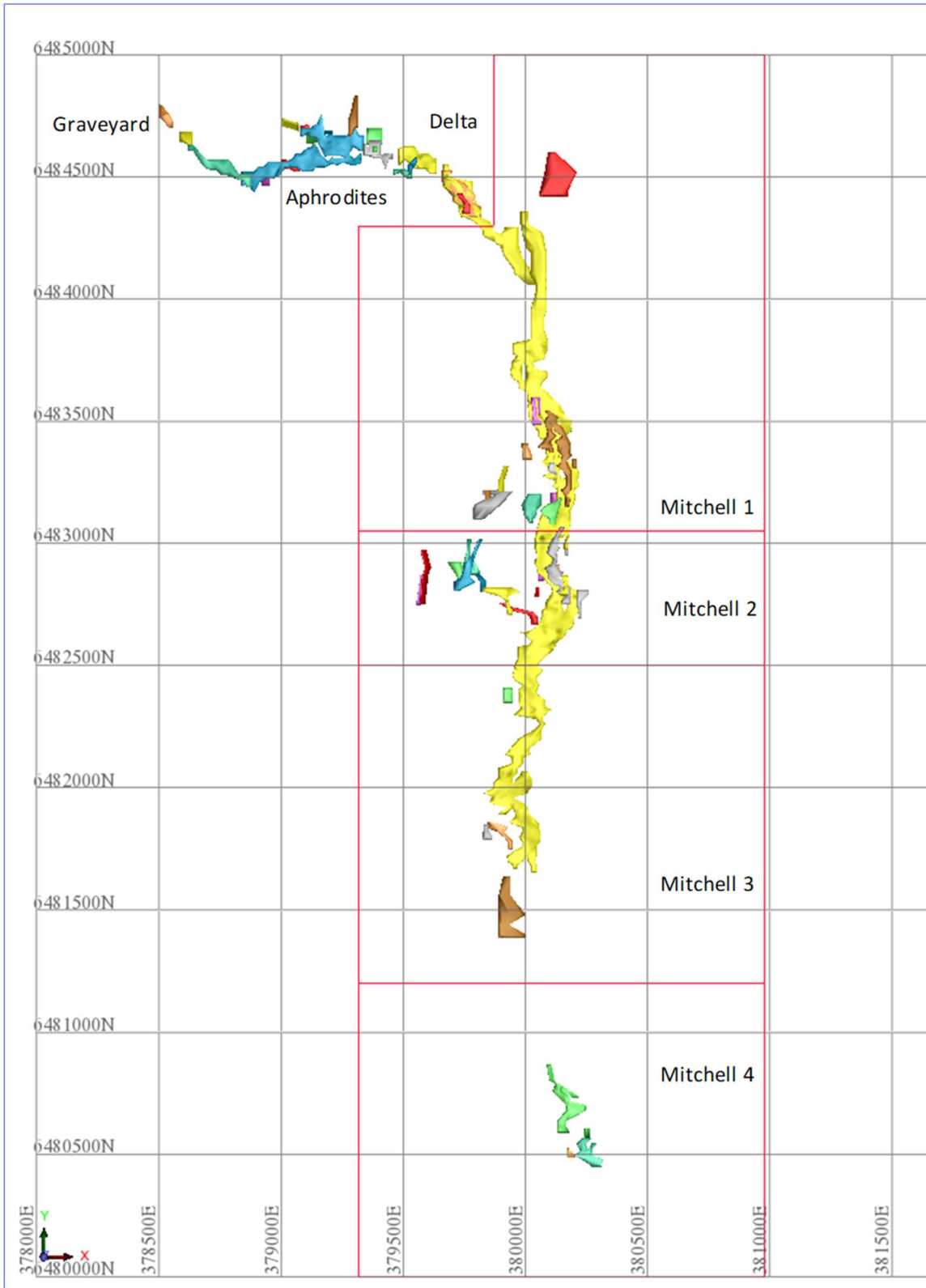

The gold mineralisation occurs within 2 m to 3 m of the Tertiary sediments/weathered Archean boundary and is associated with sand, grits and conglomerates. Minor mineralisation occurs a couple of metres from the base of the Tertiary sediments, probably representing another influx of mineralisation transported from the primary source. Morphologies of gold grains suggest Placer gold (nuggets observed up to 1 cm) and secondary gold (reduced sands and clays) are present.

There is also local supergene enrichment of the underlying weathered basement.

14.3.7.2 Drilling and Sample Data

The deposit has been drilled by several companies using predominantly surface aircore and RAB methods, although RC and diamond holes have also been completed across the deposit.

Westgold extracted drill information from the Datashed database on March 14, 2018. The export included holes drilled by Samantha, Resolute, WMC and Avoca from 1988 over 17 different drill campaigns. A summary of drilling at the deposit is shown in Table 14-31.

Table 14-31 Mitchell Deposit – data export summary

Drill Hole Type	Actual		Percentage	
	Drill Holes	Metres	Drill Holes	Metres
Auger	3	15.7	0.2%	0.0%
RAB	276	17,257	14%	17%
Aircore	1,636	69,983	83%	69%
RC	51	12,370	3%	12%
Diamond	3	1,818.80	0.2%	2%
Total	1,969	101,445	100%	100%

RAB and auger holes were used in the interpretation, but the assays were excluded from estimation.

Of the drill holes from the XHGO-2016-116 drill program, 14 were excluded from the estimation process due to drilling through back fill. The XHGO-2016-116 drill program was designed to determine remaining mineralisation left by Resolute in the existing Mitchell Pit as there was no final mining survey completed. This was made more difficult by the surrounding pit walls which had slumped since the pit was closed in 1999.

QA/QC data were available only for more recent drilling. The earlier Samantha and Resolute data did not have associated QA/QC data. Metals X/Westgold's program included the following:

- Field duplicates every 75 samples (59 submitted, 22% had outliers);
- Coarse reject duplicates;
- Regular submission of CRM standards (377 submitted, 6% failed);
- Regular submission of blanks, usually coarse sand or unmineralized RC chips (59, 4% outliers);
- Regular monitoring and follow-up with the laboratory when acceptable parameters are exceeded;
- Use of independent laboratories for surface diamond core; and
- Onsite laboratory participation in Intertek monthly round robin analysis of blind CRM material.

14.3.7.3 Density

The bulk density values assigned to the weathering profile were the same values used at the HGO Lake Cowan Project. The density assigned to the paleochannel material was that used in the previous model completed by LBC Resources (2006) and was based on the results of four diamond drill holes completed at the Mitchell and Challenger deposits. Density values applied to the model are shown in Table 14-32.

Table 14-32 Density values used in Mitchell model

Material	Bulk Density (t/m ³)	Source
Transported	1.50	Discussion and agreement from Exploration Department
Paleochannel	1.85	Mitchell Resource by LBC Resources (2006)
Oxide	2.10	From Lake Cowan Project
Transitional	2.40	From Lake Cowan Project
Fresh	2.70	From Lake Cowan Project
Waste Dumps/Infill	1.40	Discussion and agreement from Engineering Department

14.3.7.4 Modelling Domains

The deposit was subdivided into lodes with differentiation based on the dominant style of mineralisation and the relative spatial distribution of each. The initial interpretation was digitised on 20 m (local) northing sections into GEOVIA Surpac™ 3D modelling package. The wireframes were validated in three dimensions to ensure consistency of lode shape and to accurately capture any cross-cutting relationships between the mineralised zones.

All the mineralised envelopes were modelled using a 0.5 g/t Au cut-off with a minimum downhole length of 2 m and a maximum dilution of 2 m internal dilution. Each separate wireframe was given a separate object number.

A total of 17 flat lodes (100 series) and seven steep lodes (Domains 202 to 208) were interpreted at Mitchell covering a strike length of 2.6 km.

Due to the lack of geological codes in the database, (particularly the historical drill holes) and multiple generations of data, the oxidation surface was based on several constraints.

The BOCO and TOFR surfaces were primarily based on the *Lith1_Oxidation* field (Weathering Code) in the *Lithology* table. If the *Lith1_Oxidation* code was not present, then the surfaces were based on the *Regolith* field (Regolith Group Code) under the *Regolith* Table.

The base of Paleochannel (BOA) surface and the base of transported/soil (BOT) surface was based on the *RegolithAge* field (Regolith Group Code) under the *Regolith* Table and the *Lith1_Colour1* field under the *Lithology* table.

14.3.7.5 Statistical Analysis and Compositing

The wireframes of the mineralised lodes were used to code the drill hole intersection into the database to allow identification of the resource intersections. GEOVIA Surpac™ was then used to extract downhole composites within the different resource domains. Holes were composited to 1 m with a minimum of 0.5 m. Individual composite files were created for each of the domains in the wireframe models. Domain interpretation was based on the dominant style of mineralisation and the relative spatial distribution of each. The initial interpretation was digitised on 20 m northing sections. Lode 105 was the only flat lode that had sufficient data to allow for

statistical analysis to be completed. The rest of the individual sub-domains did not contain enough data to allow for any meaningful statistical analysis and therefore the parameters for Domain 105 were applied to the rest of the 100 series.

Summary statistics for the individual domains for both raw data and composite data are presented in Table 14-33 and Table 14-34.

Table 14-33 Summary statistics for Mitchell Flat lodes

Domain	Samples	Minimum	Maximum	Mean (g/t)	Standard deviation	CV
All	2,269	0.005	504	2.41	12.01	4.98
102	160	0.005	198	3.48	16.13	4.63
103	52	0.005	59.2	4.09	9.61	2.35
104	76	0.005	63.3	3.59	8.31	2.31
105	1,573	0.005	35.8	2.02	3.17	1.57
106	29	0.005	11.2	2.05	3.19	1.56
107	56	0.005	504	10.9	67.21	6.17
108	52	0.01	46.8	2.73	6.48	2.37
109	72	0.005	7.15	1.09	1.2	1.1
110	89	0.005	41.5	2.09	4.95	2.37
111	8	0.06	1.2	0.56	0.42	0.76
112	12	0.06	5.38	1.29	1.43	1.11
113	15	0.03	20.2	3.72	5.93	1.6
114	10	0.16	1.3	0.49	0.33	0.67
115	15	0.005	9.75	1.29	2.42	1.87
116	8	0.009	35.2	5.19	12.17	2.34
118	24	0.005	7.05	1.14	1.55	1.36
119	6	0.005	2.44	0.73	1.01	1.39

Table 14-34 Summary statistics for Mitchell Steep lodes

Domain	Samples	Minimum	Maximum	Mean (g/t)	Standard deviation	CV
All	45	0.005	79.4	4.07	14.334	3.526
202	14	0.005	79.4	9.84	26.254	2.668
203	4	0.14	1.79	0.98	0.815	0.831
204	5	0.18	1.4	0.63	0.508	0.804
205	10	0.04	3.16	1.28	1.087	0.852
206	3	1.34	22.5	10.16	11.684	1.15
207	2	0.21	1.82	1.02	1.027	1.012
208	7	0.02	2.42	0.8	0.892	1.119

The log histogram and log probability plots for Domain 105 are shown in Figure 14-31.

Figure 14-31 Log histogram and log probability plots for Domain 105

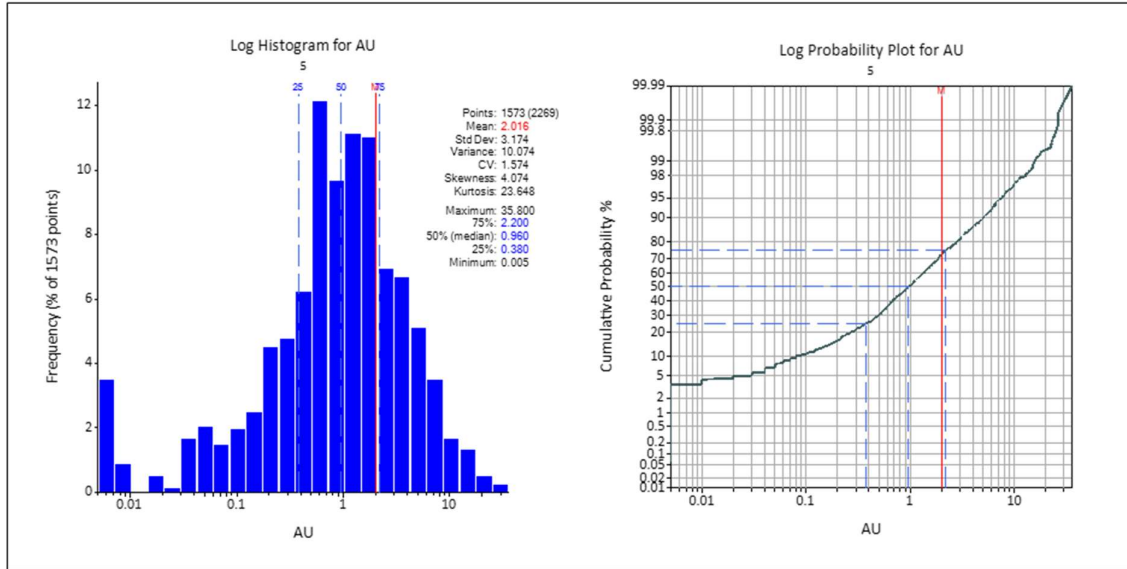

Top-cuts were determined by assessing normal and log-histograms for extreme values and using a combination of mean variance plots and population disintegration techniques. A top-cut of 12 g/t was applied to 11 flat lodes and a top-cut of 8 g/t was applied to three of the steep lodes.

14.3.7.6 Variography

Understanding the grade continuity and determining its extent and orientation is achieved through interpreting and modelling the experimental variogram. The experimental variogram requires sufficient sample data to provide a reliable measure of the grade continuity. Westgold modelled variograms for the grouped flat lodes (100 series) and again for the steep lodes (200 series). The resultant parameters are summarised in Table 14-35.

Table 14-35 Variogram parameters for Mitchell grouped domains

Domain	Direction	Nugget	Structure 1		Structure 2		Structure 3		Bearing Plunge Dip	Semi Major Ratio	Semi Minor Ratio
			Sill	Range	Sill	Range	Sill	Range			
100's	00 → 150	0.41	0.37	20	0.12	65	0.1	145	150	1.11	1.3
	00 → 060			18		50		95	0	20	32.5
	90 → 000			1		2		3	0	1.53	48.33
200's	00 → 280	0.41	0.37	20	0.12	65	0.1	145	0	1.11	1.3
	00 → 190			18		50		95	0	20	32.5
	90 → 000			1		2		3	-65	-	-
Waste	-02 → 090	0.24	0.72	75	0.01	240	-	-	100	10.71	2.18
	-10 → 360			7		110		-	0	7.5	2.4
	80 → 010			10		100		-	0	-	-

14.3.7.7 Block Model and Grade Estimation

A block model was created using GEOVIA Surpac™ to encompass the full extent of the deposit. A parent block size of 10 m NS x 10 m EW x 10 m vertical with sub-blocking to 1.25 m x 1.25 m x 1.25 m was used. The selected parent block size was based on the results of a kriging neighbourhood analysis (KNA), while the sub-block size was selected to provide sufficient resolution to the wireframe geometry represented in the block model.

Grade estimation was completed using ordinary kriging (OK) interpolation using GEOVIA Surpac™. The wireframes were used as a hard boundary for the grade estimation of each domain. That is, only grades inside each lode were used to interpolate the blocks inside the lode.

An 'ellipsoid' search orientated to reflect the geometry of the individual lodges was used to select data for interpolation. The search ellipse was based on the kriging parameters but adjusted to reflect the local changes in each of the minor lodges.

Four estimation passes were used for the interpolations. A first pass search radius was based on the experimental variogram ranges. Search distances were doubled for each successive pass. A minimum of 8 samples was required in the first pass and this was reduced to 4 across pass 2 and 3, and then 2 for the final pass. A maximum of 20 samples was set, and a limit of 4 samples per drill hole was imposed.

14.3.7.8 Model Validation

The model was validated by the following:

- Volume comparison between wireframes and cell volumes,
- Comparison of overall mean grades and de-clustered mean sample grades,
- Section and elevation validation profiles (swath plots) were created,
- Comparison with previous resource model, and
- Reconciliation of pit shape with reported production.

A comparison was completed between the Resolute claimed mined ore and mined digital surfaces. McEwan (2000) stated that ≥ 1.0 g/t ore was hauled to the Chalice Mill for processing from the Mitchell Pit. The flagged mined (includes possible mined material; mined attribute = 2) area in the current model is within 6% of the tonnes and 1% of the ounces of the claimed mined by Resolute. This suggests the mined area in the model is representative of what was processed and mined by Resolute.

14.3.7.9 Mineral Resource Classification

The final resource classifications for each domain, or part thereof, were assigned with consideration for the confidence in the tonnage/grade estimations, reliability of input data, confidence in continuity of geology and metal values, quality, quantity, and distribution of the data. The Mitchell Mineral Resource was classified in accordance with the JORC Code 2012 guidelines. A reconciliation of this reporting and the CIM Definition Standards (2014) by the Qualified Person shows no material differences.

The Indicated category was assigned to all well drilled areas of the deposit where data were supported by adequate QA/QC checks.

The Inferred category was assigned to the remaining lodges to extrapolated distances not exceeding 40 m.

Domains estimated using RAB or AC holes, or defined by single drill holes, were considered mineral potential.

14.3.7.10 Mineral Resource Statement

The Mineral Resource Statement presented herein sets out the Gold Mineral Resource estimate prepared in accordance with the Canadian Securities Administrators' National Instrument 43-101 and Form 43-101F. The Mineral Resource estimate as set out in Table 14-36 is effective as of September 30, 2023. The Mineral Resource at the Mitchell gold deposit has been reported using a 0.5 g/t Au cut-off and has been depleted for historical open pit mining.

Table 14-36 Mitchell Depleted Mineral Resource using 0.5 g/t Au cut-off

MRE Summary	Measured			Indicated			Measured & Indicated			Inferred		
	kt	g/t	koz	kt	g/t	koz	kt	g/t	koz	kt	g/t	koz
Mitchell	-	-	-	372	2.5	30	372	2.5	30	49	2.8	4

- 1) Mineral Resources that are not Mineral Reserves do not have demonstrated economic viability. There is no certainty that all or any part of the Mineral Resources estimated will be converted into Mineral Reserves.
- 2) The Measured and Indicated Mineral Resources are inclusive of those Mineral Resources modified to produce Mineral Reserves.
- 3) The Mineral Resource estimates include Inferred Mineral Resources that are normally considered too speculative geologically to have economic considerations applied to them that would enable them to be categorized as Mineral Reserves. There is also no certainty that Inferred Mineral Resources will be converted to Measured and Indicated categories through further drilling, or into Mineral Reserves once economic considerations are applied.
- 4) The Gold Mineral Resources are estimated using a long-term gold price of US\$1,700/oz with a USD:AUD exchange rate of 0.70.
- 5) The Gold Mineral Resource was reported using a 0.5 g/t cut-off grade taking into account variable operational costs associated with the Higgsவில் Open Pits.
- 6) Classification is according to JORC Code and CIM Definition Standards Mineral Resource classification categories.
- 7) The Mineral Resource is depleted for mining to September 30, 2023.
- 8) To best represent 'reasonable prospects of eventual economic extraction', the Mineral Resource for open pits has been reported within an optimized pit shells at A\$2,429/oz (US\$1,700/oz).
- 9) Mineral Resource tonnage and contained metal have been rounded to reflect the accuracy of the estimate, and numbers may not add due to rounding.
- 10) Gold Mineral Resource estimates were prepared under the supervision of Qualified Person S. Devlin, FAusIMM (Chief Geological Officer, Karora Resources).

14.3.8 Pluto

14.3.8.1 Summary

The Pluto deposit lies approximately 8 km SSW of the Higgsவில் Mill and is situated at the southern extent of the Challenger-Swordsman Paleochannel system which includes the Neptune, Saturn, Jupiter, Mars, Mercury, Venus and Bullseye areas.

Pluto was modelled by Avoca in 2006 and revised by Metals X in 2014.

Mining of Challenge (including part of Pluto) was completed in the 1990s by Resolute and produced 2.06 Mt at 3.4 g/t for 228 koz mined.

The Pluto Deposit is at the south-western lower reaches of the Challenger-Swordsman palaeochannel system, where the channel has shallow gradient margins and a slightly undulating base over 200 m wide. An upper and lower transported sequence has been

identified with the upper transported sequence comprised primarily of 10 m to 15 m of sandy and pisolitic clays (known as the Revenge Formation) and a lower transported sequence containing four marked formations, the thickest and most important being the Werillup Formation, host to most of the mineralisation at Challenge. The formation comprises mainly carbonaceous clays overlaying a basal sand channel facies. The base of the channel truncates the lower saprolite in the underlying Archaean basement. The base of the channel is marked by a 0.3 m to 3.0 m thick quartzitic gravel lag, overlain by several upward fining cycles of reduced Eocene sedimentary sands, silts and clays.

14.3.8.2 Drilling and Sample Data

The deposit has been drilled by several companies using predominantly surface aircore and RAB methods, although RC and diamond holes have also been completed across the deposit (Figure 14-32).

Metals X extracted drill information from the Datashed database on June 20, 2014. The export included 4,306 m of aircore drilling, 375 m of RC and 61 m of diamond drilling. The Pluto Deposit has been drilled on a 20 m x 20 m grid spacing.

Drill holes were sampled at 1 m intervals using a cyclone. No other details of sampling are available.

All Pluto assays were analysed at Minilabs in Kalgoorlie. QA/QC procedures were followed.

Drill hole locations were translated from mine grid to AMG84 and Metals X found and documented some corrections in the conversion between the two grid systems resulting in a 3.7 m potential error in the horizontal plane and 0.7 m vertically.

The surface topography and mine surveys indicated issues due to slumping, in-pit dumping and stockpiling.

Figure 14-32 Pluto – oblique view (looking ENE) of Au grades – drilling vs block model

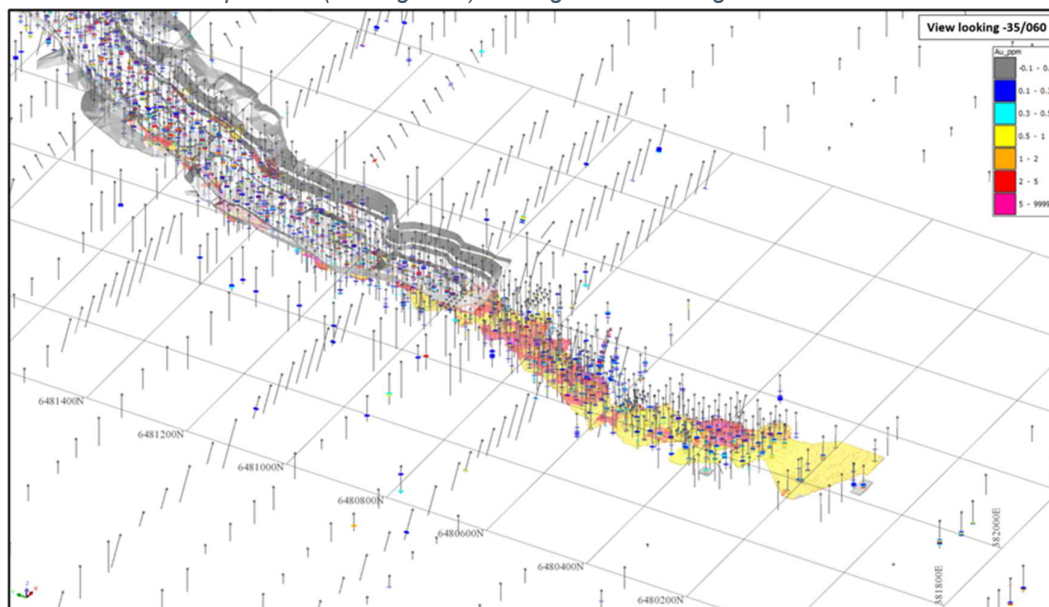

14.3.8.3 Density

For Pluto, density values were derived from the Challenger Palaeochannel open pit production records, including from Pluto (pit/waste fill, alluvial and oxide) plus nearby Vine North (transitional and basement), and assigned by oxidation state as summarised in Table 14-37.

Table 14-37 Density values assigned in the Pluto model

Material	Bulk Density (t/m ³)
Pit/waste fill	1.80
Alluvial	1.85
Oxide	1.90
Transitional	2.40
Fresh	2.89

14.3.8.4 Modelling Domains

A 3D viewing of the data was undertaken to establish a feel for the basic form and continuity of the mineralisation. This was followed by sectional viewing. Strings were digitised on section to establish a 0.5 g/t cut-off envelope around the individual mineralised zones. Generally, a maximum of 2 m continuous downhole internal dilution was allowed, and in cases where geological knowledge of the deposit allowed, the interpretation strings were continued through zones of lower grade to assist in modelling lode continuity, and to increase the level of along-strike/down dip control on the location of the mineralised structure.

All strings were digitised in a clockwise direction, with a common extent of interpretation defined as 0.5 x drill spacing beyond the last intersecting drill hole. Strings were snapped to drill holes at sample interval boundaries, with no artificial complexities introduced into the lode geometry (although points were created between drill holes to ensure accuracy during wireframing).

Modelling was undertaken in MGA94 zone 51, with a nominal sectional spacing of 20 m used during interpretation.

Four geologically mineralised domains were identified: the Alluvial/Basement Contact, Upper Alluvial, Supergene and Primary. The Alluvial/Basement Contact and the Upper Alluvial domains are most continuous, the prior containing the better grade tenor. The Alluvial Basement domain is very consistent with the contact of the alluvial and bedrock.

The BOA, BOCO and TOFR surfaces were created via the digitising of strings on sections corresponding to the geologically logged oxidation states downhole. In the first instance, strings were based on information from the oxidation table and the Regolith table. For the BOA, these digitised strings were expanded as appropriate to extend beyond the borders of the block model, with a digital terrain model (DTM) created by triangulating between adjacent strings. For the BOCO and TOFR, the DTM was expanded to cover the relevant portion of the mineralisation.

Metals X noted significant differences between depths of weathering from hole to hole which were attributed to the influence of discrete preferentially weathered structures or were indicative of conflicting logging regimes.

The Challenge/Pluto mineralisation was defined by the 100 series domains confined to the Upper Alluvial, and the 600 series domains at the Alluvial/Basement Contact. It appears that the

Pluto deposit is arbitrarily designated to the south of the paleochannel system, south of 6,481,790 mN (Figure 14-33).

Figure 14-33 Challenge/Pluto location plan

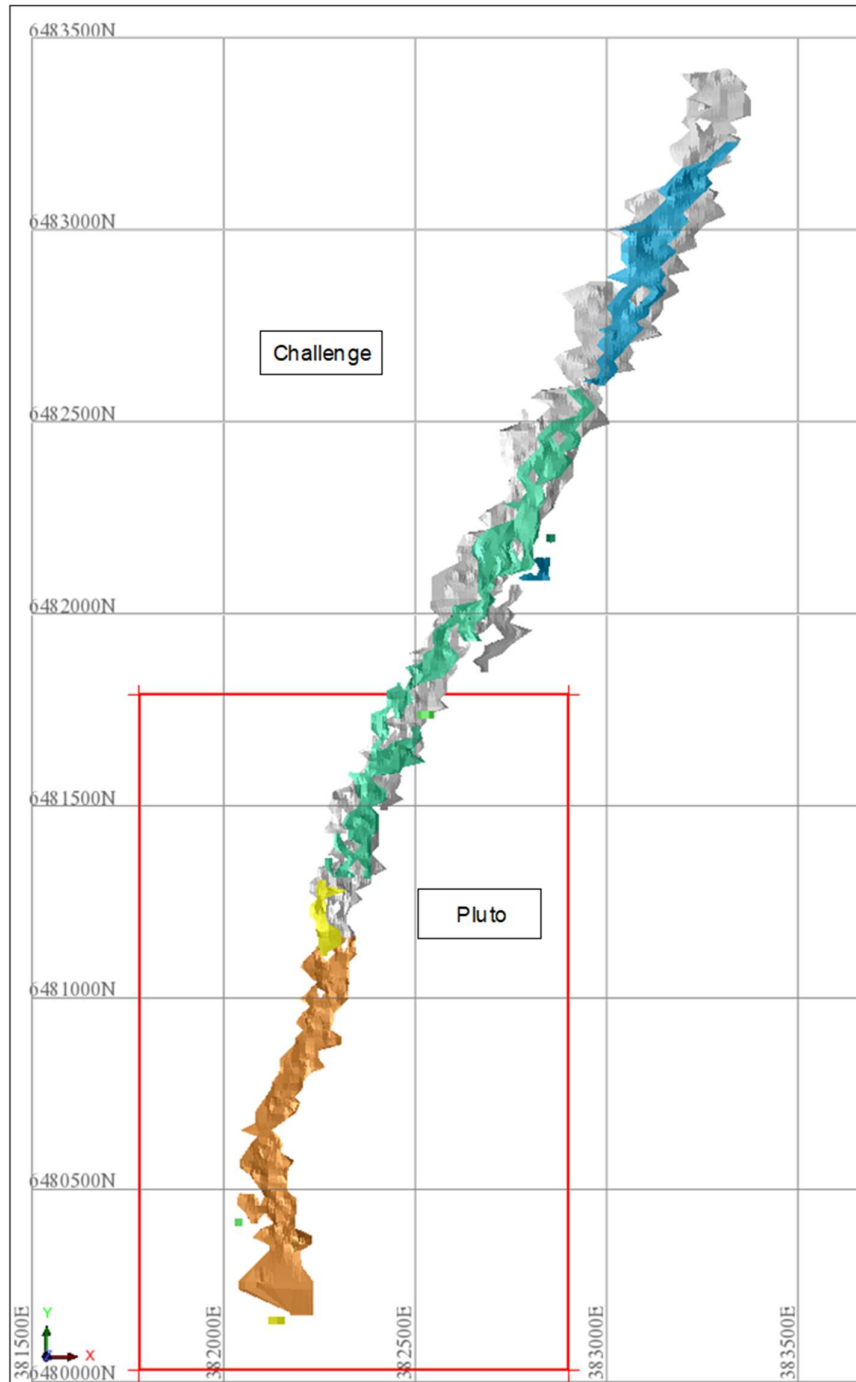

14.3.8.5 Statistical Analysis and Compositing

The interpreted mineralisation wireframes were used to create intersection tables within the database by marking for extraction all intervals of drill holes enclosed by the volume model. Each intersection was flagged according to the object intersected, with numerical codes assigned as appropriate.

One metre composites of the downhole assay results from the holes in the project area were used in the statistical analysis and resource calculation. Composites were taken from within the volume model, with the composite length chosen based on the dominant sample length within the database. Comparisons of the different composite lengths showed that 98.98% of composites were 1 m which contained 99.09% of the total metal.

14.3.8.6 Statistics and Interpretation

Statistical comparisons were completed on all domains to determine whether domains could be statistically combined or whether further sub-domaining was required.

Statistical analysis on the 600 series domains by Metals X revealed that the northern portion of the Alluvial/Basement domain was higher grade (HG) than the southern (LG) and should therefore be sub-domained to prevent smearing.

The 1m composite files of downhole assay data were ranked. Datasets were then graphed and analysed for disintegrations, defined as the first significant increase in percentage difference between adjacent values for assay values sufficiently above the mean assay value for the dataset.

Domains were assessed for outliers. A top-cut of 40 g/t was applied to the LG 600 series domains, and a top-cut of 50 g/t was applied to the HG 600 series domains.

14.3.8.7 Variography

Understanding the grade continuity and determining its extent and orientation is achieved through interpreting and modelling the experimental variogram. The experimental variogram requires sufficient sample data to provide a reliable measure of the grade continuity. Directional variogram models were completed for the 100 and 600 series domains revealing nugget effects of 42% for the 100 series and 600 series (HG), and a nugget effect of 38% for the LG 600 series. The modelled major ranges for the 100 and 600 series ranged from 61 m to 92 m.

14.3.8.8 Block Model and Grade Estimation

A block model was created using GEOVIA Surpac™ to encompass the full extent of the deposit. A parent block size of 20 m NS x 20 m EW x 1 m vertical with sub-blocking to 5 m x 5 m x 0.5 m was used. The selected parent block size was based on the results of a kriging neighbourhood analysis (KNA), while the sub-block size was selected to provide sufficient resolution to the wireframe geometry represented in the block model.

Grade estimation was completed using ordinary kriging (OK) interpolation using GEOVIA Surpac™. The wireframes were used as a hard boundary for the grade estimation of each domain. That is, only grades inside each lode were used to interpolate the blocks inside the lode.

An 'ellipsoid' search orientated to reflect the geometry of the individual lodges was used to select data for interpolation. Search ellipses were aligned parallel to the maximum continuity defined during the variogram analysis. The search dimensions approximated the ranges of the

interpreted variogram models. Three estimation passes were used for the interpolations. The minimum number of samples was set to 8, and the maximum number of samples was set to 16 for all Pluto domains.

14.3.8.9 Model Validation

The block model was validated visually on a section basis by comparing estimated blocks to drill holes. In addition, a number of statistical tools were employed, including the following:

- Trend analysis of estimated grades versus input composites on sections and elevations,
- Q-Q plots, and
- Box and whisker plots.

Validation analysis indicated that the block model for all domains was robust at a global scale. Local high-grade spikes were under-reported and conversely low-grade spikes were over-reported in the model, in many cases. This can be seen in the trend analysis graphs and was due to the smoothing effect of the estimation technique employed.

14.3.8.10 Mineral Resource Classification

The Pluto Mineral Resource was classified as follows:

- For Pluto, the resource was classified as all Inferred. Portions of the resource that are on 20 m x 20 m drill spacing were classified as Inferred due to topographic and collar survey concerns.
- An area was classified as Inferred Mineral Resource where the data density was sufficient to imply but too sparse to verify geological and grade continuity. Inferred material is not interpolated or extrapolated past 40 m grid spacing in all directions past the last data point.
- Portions of the Pluto deposit directly below the pit, where there is poor data density, poor geological confidence or over estimation of high grade were unclassified and excluded from the Mineral Resource.

The Pluto Mineral Resource was classified in accordance with the JORC Code 2012 guidelines. A reconciliation of this reporting and the CIM Definition Standards (2014) by the Qualified Person shows no material differences.

14.3.8.11 Mineral Resource Statement

The Mineral Resource Statement presented herein sets out the Gold Mineral Resource estimate prepared in accordance with the Canadian Securities Administrators' National Instrument 43-101 and Form 43-101F. The Mineral Resource estimate as set out in Table 14-38 is effective as of September 30, 2023. The Mineral Resource at the Pluto gold deposit has been reported using a 0.5 g/t Au cut-off and has been depleted for historical open pit mining.

Table 14-38 Pluto Depleted Mineral Resource using 0.5 g/t Au cut-off

MRE Summary	Measured			Indicated			Measured & Indicated			Inferred		
	kt	g/t	koz	kt	g/t	koz	kt	g/t	koz	kt	g/t	koz
Pluto	-	-	-	-	-	-	-	-	-	119	3.2	12

- 1) Mineral Resources that are not Mineral Reserves do not have demonstrated economic viability. There is no certainty that all or any part of the Mineral Resources estimated will be converted into Mineral Reserves.
- 2) The Measured and Indicated Mineral Resources are inclusive of those Mineral Resources modified to produce Mineral Reserves.
- 3) The Mineral Resource estimates include Inferred Mineral Resources that are normally considered too speculative geologically to have economic considerations applied to them that would enable them to

be categorized as Mineral Reserves. There is also no certainty that Inferred Mineral Resources will be converted to Measured and Indicated categories through further drilling, or into Mineral Reserves once economic considerations are applied.

- 4) The Gold Mineral Resources are estimated using a long-term gold price of US\$1,700/oz with a USD:AUD exchange rate of 0.70.
- 5) The Gold Mineral Resource was reported using a 0.5 g/t cut-off grade accounting for variable operational costs associated with the Higgsville Open Pits.
- 6) Classification is according to JORC Code and CIM Definition Standards Mineral Resource classification categories.
- 7) The Mineral Resource is depleted for mining to September 30, 2023.
- 8) To best represent 'reasonable prospects of eventual economic extraction', the Mineral Resource for open pits has been reported within an optimized pit shells at A\$2,429/oz (US\$1,700/oz).
- 9) Mineral Resource tonnage and contained metal have been rounded to reflect the accuracy of the estimate, and numbers may not add due to rounding.
- 10) Gold Mineral Resource estimates were prepared under the supervision of Qualified Person S. Devlin, FAusIMM (Chief Geological Officer, Karora Resources).

14.3.9 Vine

14.3.9.1 Summary

The Vine gold deposit is located approximately 3 km south of the Higgsville Mill and is one of the deposits included in the Line-of-Lode deposits (Figure 14-34). From 2011 to 2012, the deposit was mined in two open pit stages by Avoca and produced a reconciled total of 183,297 t at a grade of 2.2 g/t for 12,921 oz. Since the cessation of mining, the open pit has been used as a tailings storage facility.

The Vine Deposit consists of a series of north-south trending, steeply dipping quartz veins, hosted predominantly by the Vine gabbro. The main veins are evenly spaced apart from east to west by approximately 100 m. The 550 and 650 Veins are the dominant mineralized veins, and each main lode is named after the approximate MGA94 easting it is located on.

The deposit has shown considerable depth extent in the 750 series area, made up of numerous relatively narrow steeply dipping quartz vein structures and sub-horizontal structures at modest grade, so presents challenges for developing an underground resource.

Vine is divided into four distinct areas; 550 Vein, 650 Vein, 750 Vein and Pipeline, and is characterised as north-south discrete vertical quartz veins. Flat lying mineralisation/quartz veins have been found to exist between these major vertical quartz veins. Vine is very similar to the Trident deposit in that it is hosted within a discrete gabbro host rock.

The most recent mineral resource was compiled by Metals X in 2016, using GEOVIA Surpac™. This model incorporated interpretation of the depth extension of the quartz veins which had not been included in previous models. The mineralisation at depth consists of an exploration target 'Vine Deeps' (Westgold, 2017b).

Figure 14-34 Vine and Fairplay group locations, within Higginsville Central area

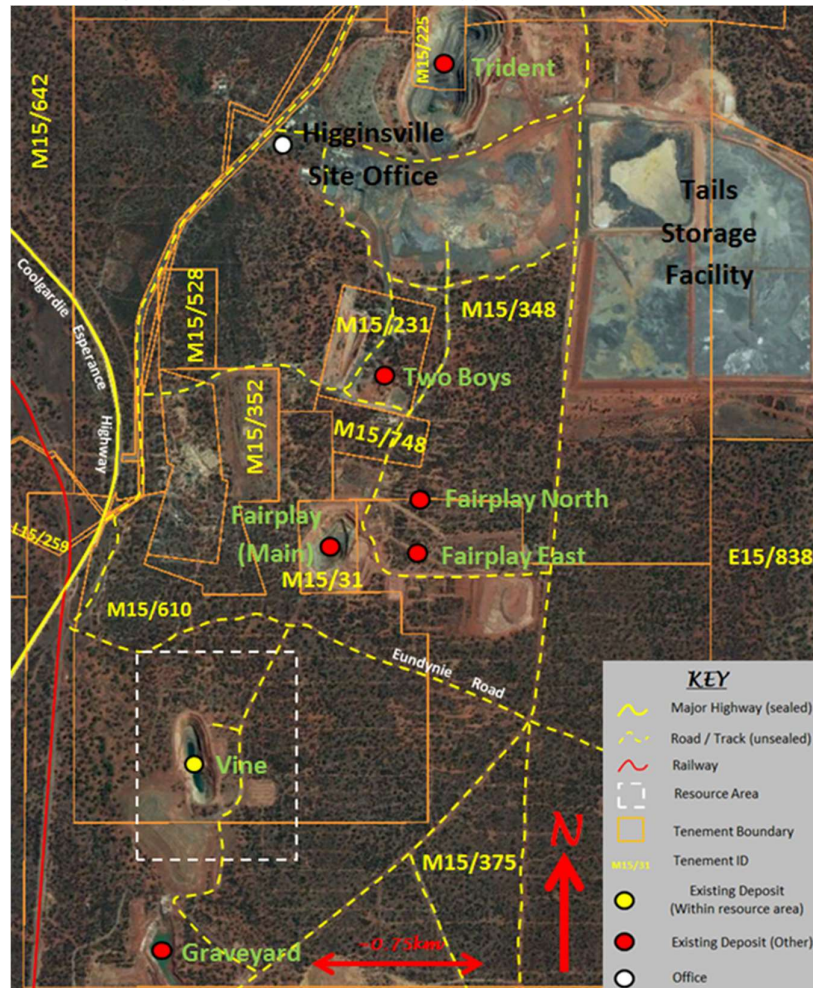

14.3.9.2 Drilling and Sample Data

Drilling data for the 2016 model was extracted to a cut-off date of December 15, 2015. There was no additional drilling carried out at Vine after 2013.

14.3.9.3 Modelling Domains

The Vine mineralisation occurs as dominantly north-south trending quartz vein sets with additional sub-horizontal sets, hosted within a basalt to gabbro series.

The naming of interpreted mineralisation domains was based on geometry and spatial position:

- 100s series – vertical lode/quartz veins – 550 Vein, includes the northern faulted vein previously called the 450 Vein.
- 200s series– vertical lode/quartz veins – 650 Vein, does not reach the surface.
- 300s series – vertical lode/quartz veins – 750 Vein. The deepest set of lodes and do not reach the surface. These lodes cannot be mined by open pit methods due to the depth of the lodes.
- 400s series – vertical lode/quartz veins – Pipeline. These are the most south-eastern lodes within the Vine deposit.
- 500s series – flat lying, supergene mineralisation within the oxide material.

- 600s series – flat lying, within the transitional material.
- 700s series – flat lying, within the fresh material, using structural data (dip and azimuth) collected from diamond drill holes to guide lode interpretation (Figure 14-35).

Figure 14-35 Example of structural data used to guide flat lying lode interpretations

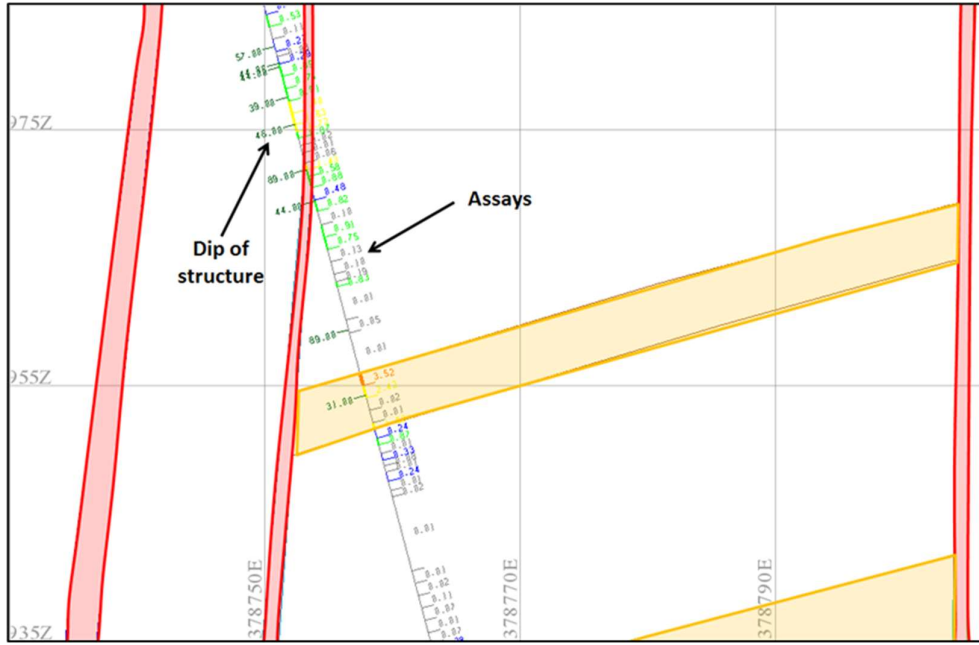

Weathering surfaces were created using drill hole logging codes, for BOCO and TOFR.

14.3.9.4 Statistical Analysis, Compositing and Variography

The mineralized domains were composited to 1 m samples. Top-cuts were applied to individual domains where required and variogram models were produced for the most informed domains: 101, 201 and 501. The variogram models were used for lesser informed domains with similar orientation.

The 300, 400, 600 and 700s data were grouped together in their similarly orientated domains and variogram models were computed from the combined data.

14.3.9.5 Density

Density values were assumed and were based on those used at adjacent Line-of-Lode deposits. The density values applied to the model are summarised in Table 14-39.

Table 14-39 Line-of-Lode density values used for Vine

Material	Bulk Density (t/m ³)
Cover	1.4
Oxide	1.8
Transitional	2.4
Fresh Gabbro	2.89
Waste Dumps	1.4
Quartz Veins	2.7

14.3.9.6 Block Model and Grade Estimation

The Metals X block model was created with a parent cell size of 10 mX x 10 mY x 2.5 mZ and sub-celled to 1.25 mX x 1.25 mY x 1.25 mZ to honour the volume of the mineralised lenses. The block model definition parameters are presented in Table 14-40.

Table 14-40 Block model parameters for Vine

	X	Y	Z
Minimum Coordinate	378,350	6,485,250,	450
Maximum Coordinate	378,950	6,485,200	860
Block Size	10	10	2.5
Minimum Sub-block Size	1.25	1.25	1.25
Rotation	0	0	0

Grades were estimated using an ordinary kriging interpolation with search radii based on the modelled variograms. Discretization points were set at 4 x 4 x 1. The estimation process was carried out in multiple passes as detailed in Table 14-41.

Table 14-41 Estimation strategy for Au grade interpolation

No Passes	Sample Search Distance			Numbers of Samples	
	Major	Semi-Major	Minor	Min.	Max.
Pass1	85	75	10	10	30
Pass2	85	75	10	5	30
Pass3	170	150	20	10	30
Pass4	340	300	40	2	30

The block model constrained by the vein interpretation and colour-coded by gold grade is displayed in Figure 14-36.

Figure 14-36 Oblique view – looking NE – of Vine block model colour-coded by gold grade

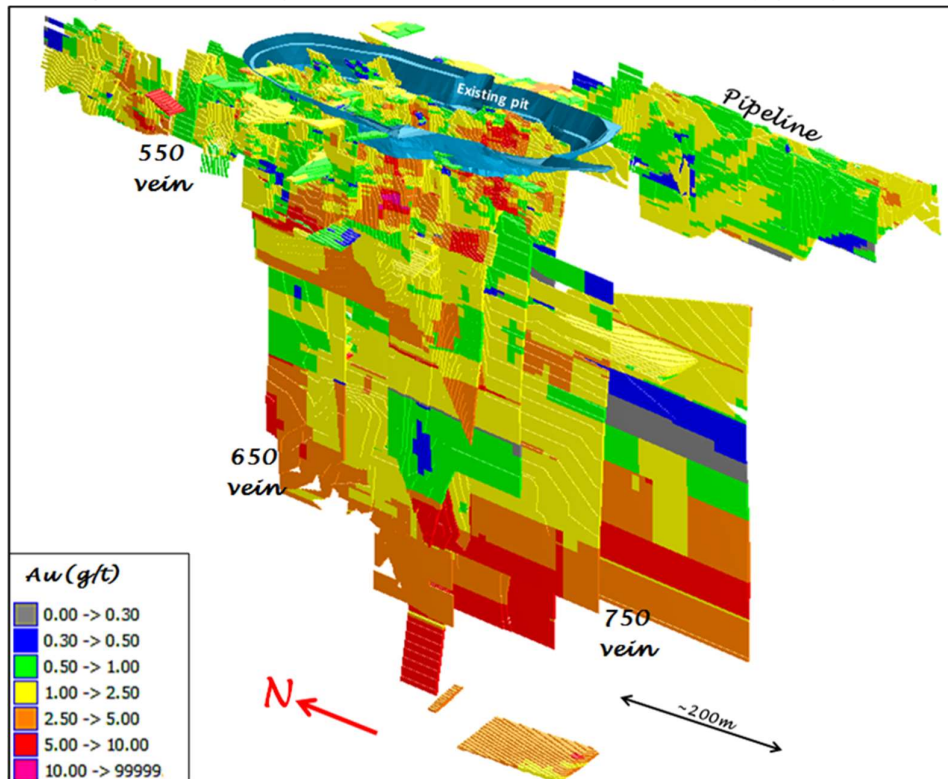

14.3.9.7 Model Validation

Metals X completed a flitch comparison of the block model with reconciled Au ounces from the mined pit which showed the estimation to be somewhat conservative. From the 237.5 mRL to 270 mRL, the ounces were approximately 25% understated in the model compared with production.

A flitch comparison of ounces (reconciled, grade control and reserve ounces) and grade from the Vine Pit, showed close correlation of the estimates with the grade control and with actual production, with stronger variation at the deepest flitches 237 mRL to 245 mRL where grades were highest from supergene effects.

14.3.9.8 Mineral Resource Classification and Reporting

The Vine Mineral Resource was classified as follows:

- A Measured Mineral Resource is that part of the Mineral Resource for which the quantity, shape, density and grade are estimated with sufficient confidence to support detailed mine planning and application of economic viability. It is based on sufficient detail of information to confirm geological and grade continuity between data and samples. At Vine, in general, material drilled on 10 m x 10 m drill spacing was classified Measured.
- An Indicated Mineral Resource is that part of the Mineral Resource for which the quantity, shape, density and grade are estimated with sufficient confidence to support detailed mine planning. Drill spacing of 20 m x 20 m or better was classified Indicated.
- An area was classified as Inferred Mineral Resource where the data density was sufficient to imply but too sparse to verify geological and grade continuity. Where drill spacing was 40 m x 40 m the mineralisation was classified Inferred.

- The Vine Mineral Resource was classified in accordance with the JORC Code 2012 guidelines. A reconciliation of this reporting and the CIM Definition Standards (2014) by the Qualified Person shows no material differences.

14.3.9.9 Mineral Resource Statement

The Mineral Resource Statement presented herein sets out the Gold Mineral Resource estimate prepared in accordance with the Canadian Securities Administrators' National Instrument 43-101 and Form 43-101F.

The Mineral Resource Statement presented herein sets out the Gold Mineral Resource estimate prepared in accordance with the Canadian Securities Administrators' National Instrument 43-101 and Form 43-101F. The Mineral Resource estimate as set out in Table 14-42 is effective as of September 30, 2023. The Mineral Resource at the Vine gold deposit has been reported using a 0.5 g/t Au cut-off and has been depleted for historical open pit mining.

Table 14-42 Vine Depleted Mineral Resource using 0.5 g/t Au cut-off

MRE Summary	Measured			Indicated			Measured & Indicated			Inferred		
	kt	g/t	koz	kt	g/t	koz	kt	g/t	koz	kt	g/t	koz
Vine	118	1.3	5	119	1.3	5	237	1.3	10	146	1.8	8

- 1) Mineral Resources that are not Mineral Reserves do not have demonstrated economic viability. There is no certainty that all or any part of the Mineral Resources estimated will be converted into Mineral Reserves.
- 2) The Measured and Indicated Mineral Resources are inclusive of those Mineral Resources modified to produce Mineral Reserves.
- 3) The Mineral Resource estimates include Inferred Mineral Resources that are normally considered too speculative geologically to have economic considerations applied to them that would enable them to be categorized as Mineral Reserves. There is also no certainty that Inferred Mineral Resources will be converted to Measured and Indicated categories through further drilling, or into Mineral Reserves once economic considerations are applied.
- 4) The Gold Mineral Resources are estimated using a long-term gold price of US\$1,700/oz with a USD:AUD exchange rate of 0.70.
- 5) The Gold Mineral Resource was reported using a 0.5 g/t cut-off grade taking into account variable operational costs associated with the Higginsville Open Pits.
- 6) Classification is according to JORC Code and CIM Definition Standards Mineral Resource classification categories.
- 7) The Mineral Resource is depleted for mining to September 30, 2023.
- 8) To best represent 'reasonable prospects of eventual economic extraction', the Mineral Resource for open pits has been reported within an optimized pit shells at A\$2,429/oz (US\$1,700/oz).
- 9) Mineral Resource tonnage and contained metal have been rounded to reflect the accuracy of the estimate, and numbers may not add due to rounding.
- 10) Gold Mineral Resource estimates were prepared under the supervision of Qualified Person S. Devlin, FAusIMM (Chief Geological Officer, Karora Resources).

14.4 HIGGINSVILLE GREATER

The Higginsville Greater area includes those deposits outside a 10 km radius from the Higginsville Mill. Mineral Resources comprise the Spargos underground deposit, the Mt Henry Project (Mt Henry, Selene, Abbotshall and North Scotia), Lake Cowan (Atreides, Josephine, Louis, Napoleon, Rose), Musket, Baloo and Paleochannels (Nanook, Wills).

14.4.1 Spargos

14.4.1.1 Summary

The Spargos gold deposit is located within the Higginsville Regional Exploration Area defined by Karora which includes the Higginsville Gold Operations.

The Spargos Deposit is located approximately 65 km northwest of the Higginsville Mill, approximately 50 km south of Coolgardie and 20 km west of Kambalda. The Project is located adjacent to the Coolgardie-Esperance Highway centred around the historic Spargos Reward Gold mining centre.

At Spargos, the geological setting comprises tightly folded north-south striking ultramafic and mafic volcanic rocks at the northern closure of the Widgiemooltha Dome.

The Spargos Deposit occurs along the general trend of the Kunanalling Shear, a regional shear zone that hosts significant mineralisation to the north at the Ghost Crab Deposit (Mount Marion), the Penfolds group and Kunanalling. The Zuleika Shear trend, a major 130 km long, 1 km wide crustal shear zone lies to the east of the project.

Local Archean geology is comprised of felsic-intermediate volcanics and epiclastics, metasedimentary sequences including greywacke and quartz arenites, mafic extrusive and intrusives, ultramafic extrusives and intrusives, and granitoids including pegmatites. The entire sequence generally strikes NNW, swinging around to north-easterly in the northern portion of the project area. Stratigraphy generally dips steeply to the east. Shear zones are manifested by quartz-sericite + fuchsite schists within the felsic and epiclastic units, along the margins of ultramafic units and are even seen within granitoids.

Gold mineralisation at Spargos is hosted in numerous positions with the bulk of the identified mineralisation occurring as disseminations and stringer zones of quartz-biotite-amphibole-pyrite-arsenopyrite alteration hosted at the faulted contact of a package of strongly silica-sericite-pyrite altered sodic felsic-intermediate volcanics (footwall volcanics) and a biotite-amphibole-garnet metagreywacke.

The deposit was discovered in the 1930s and operated as an underground multilevel stoping operation producing approximately 26,318 oz of gold until 1942. A significant township (Spargoville) was built to serve the historical gold mine and was all but abandoned by 1970.

Karora modelled the Spargos Deposit initially in March 2021 and various updates were completed over the next year to incorporate resource definition and grade control drilling. Karora mined the deposit by open pit which was completed in November 2022 reaching the 325 mRL in the north and the 340 mRL in the south (Figure 14-37). The pit produced 37,439 oz at a grade of 3.1 g/t.

An updated Mineral Resource estimate was completed for the Spargos gold deposit in May 2023 following the completion of four deep diamond holes targeted to intercept the down dip

interpreted extension of the main lodes. The deposit represents an underground opportunity for Karora.

Figure 14-37 Completed Spargos open pit and interpreted domains – long-section looking west

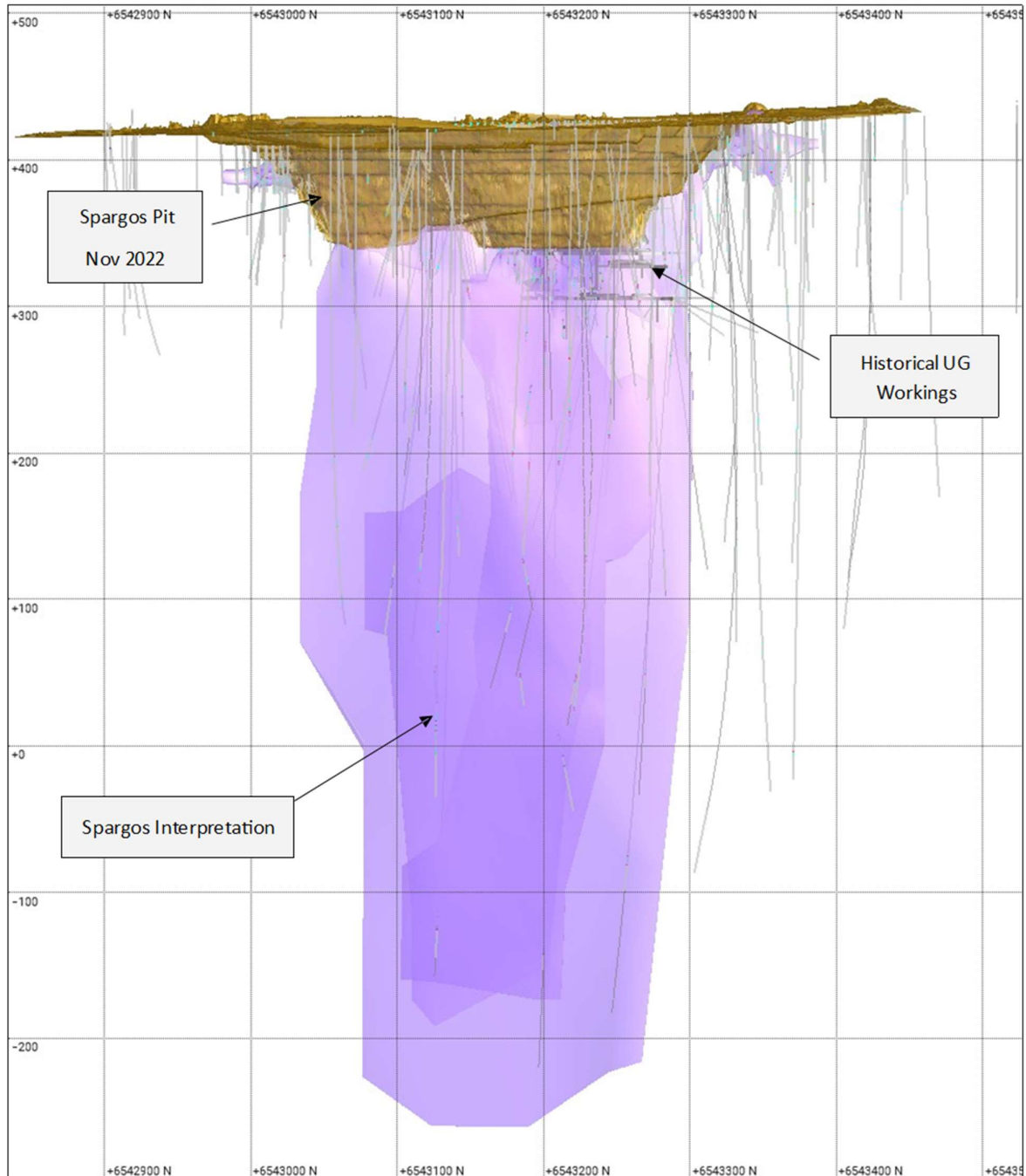

14.4.1.2 Drilling and Sample Data

The Spargos Mineral Resource estimate has been completed using historical and recent drill results of predominantly reverse circulation and diamond drilling methods. Drilling extends to a vertical depth of approximately 645 m and the mineralisation has been modelled from surface to a depth of approximately 685 m below surface.

The database used in the current estimate was exported from the Karora server on May 12, 2023. A total of 171 drill holes have intersected the interpreted lodes at Spargos for a total of 1,844 intersection metres. This includes records for 44 diamond holes, 117 RC holes, 5 RCD holes, and 5 UG grade control face samples. Only RC and diamond holes were used in the resource estimate.

A drill hole summary is included in Table 14-43.

Table 14-43 Spargos drill hole summary

Type	In Database		In Resource	
	Holes	Metres	Holes	Metres
AUG	17	40		
COSTEAN	5	245		
DDH	81	19,186	44	589
Face	18	220	5	24
NR	211	1,184		
RAB	925	7,477		
RC	1,621	84,036	117	1,171
RC/DDH	10	3,188	5	60
Total	2,888	115,576	171	1,844

14.4.1.3 Modelling Domains

The Spargos mineralisation has been interpreted using a 0.4 g/t Au cut-off to define low grade halo mineralisation to encompass potential high grade underground lodes constrained by 3 g/t cut-off. The halo cut-off was determined through statistical analysis of all samples at the deposit where population breaks were noted at 0.2 g/t and 0.4 g/t. The higher cut-off was decided upon by utilising the associated lithology logging information.

The interpreted sectional outlines were manually triangulated to form wireframes using the downhole Au grades in association with the logged lithology. To form ends to the wireframes, the end section strings were copied to a position 10 m from the section, or midway to the next section, and adjusted to match the dip, strike and plunge of the zone. Lodes were extended at depth to a distance that was half the distance to the previous up-dip mineralised intersection (125 m) or to a depth consistent with the deepest mineralised intersection.

A minimum downhole length of 2 m was used with no edge dilution. To allow for continuity, up to 2 m of internal dilution was included in some intersections. In situations where the structural continuity of the lode was interpreted to persist, lower grade assays were included.

The wireframes were set as solids after being validated using GEOVIA Surpac™ V7.4.

The BOCO and TOFR surfaces were generated to cover the entire strike length of the Spargos Deposit. The surfaces were generated by Trepanier Consultants using Leapfrog Software and were based on geology logging of all available drill data.

The Spargos Deposit comprises a main lode striking north-south with internal high-grade domains. Minor footwall lodes occur parallel to the main lode. A total of 18 domains have been interpreted (including four internal high-grade domains). Most of the smaller lodes were mined in the open pit. The mineralisation was steeply east dipping through the open pit; however, the main lode is near-vertical at depth.

A section image is shown in Figure 14-38 and a long-section view is shown in Figure 14-39.

Figure 14-38 Spargos mineralisation and completed open pit - section view looking north

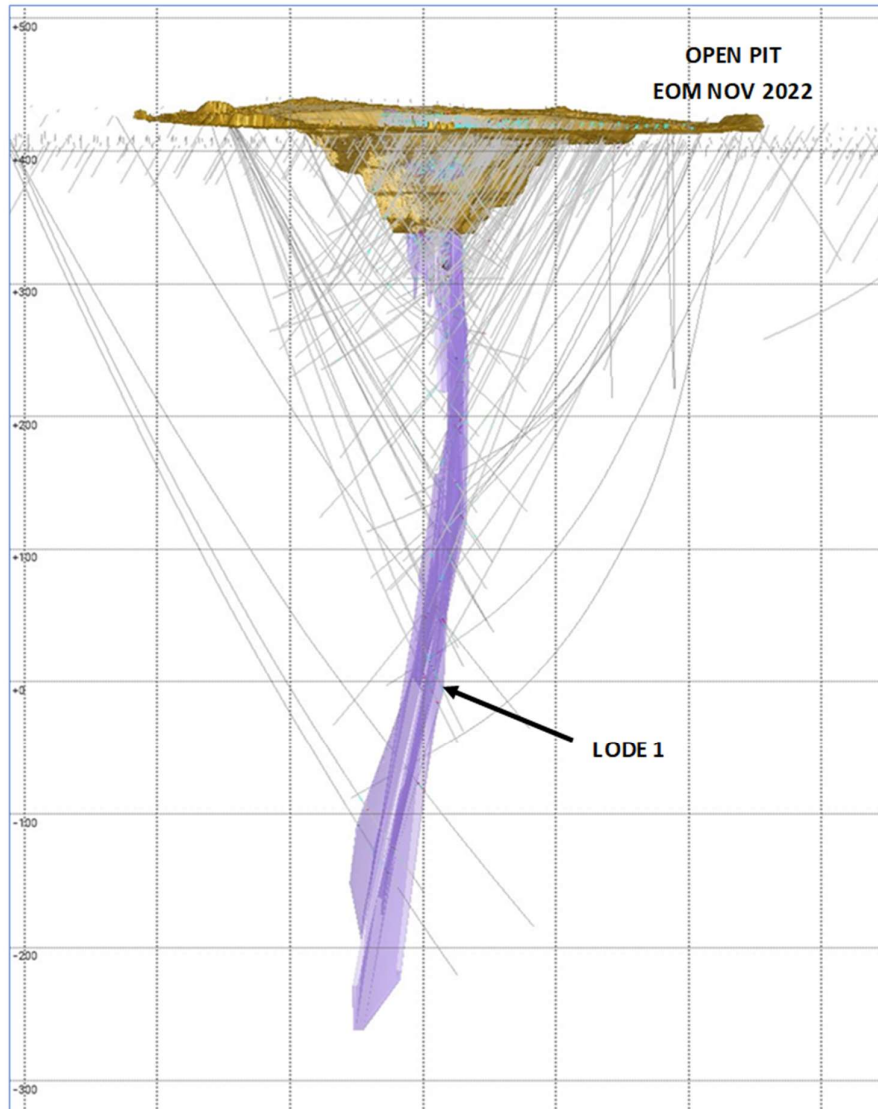
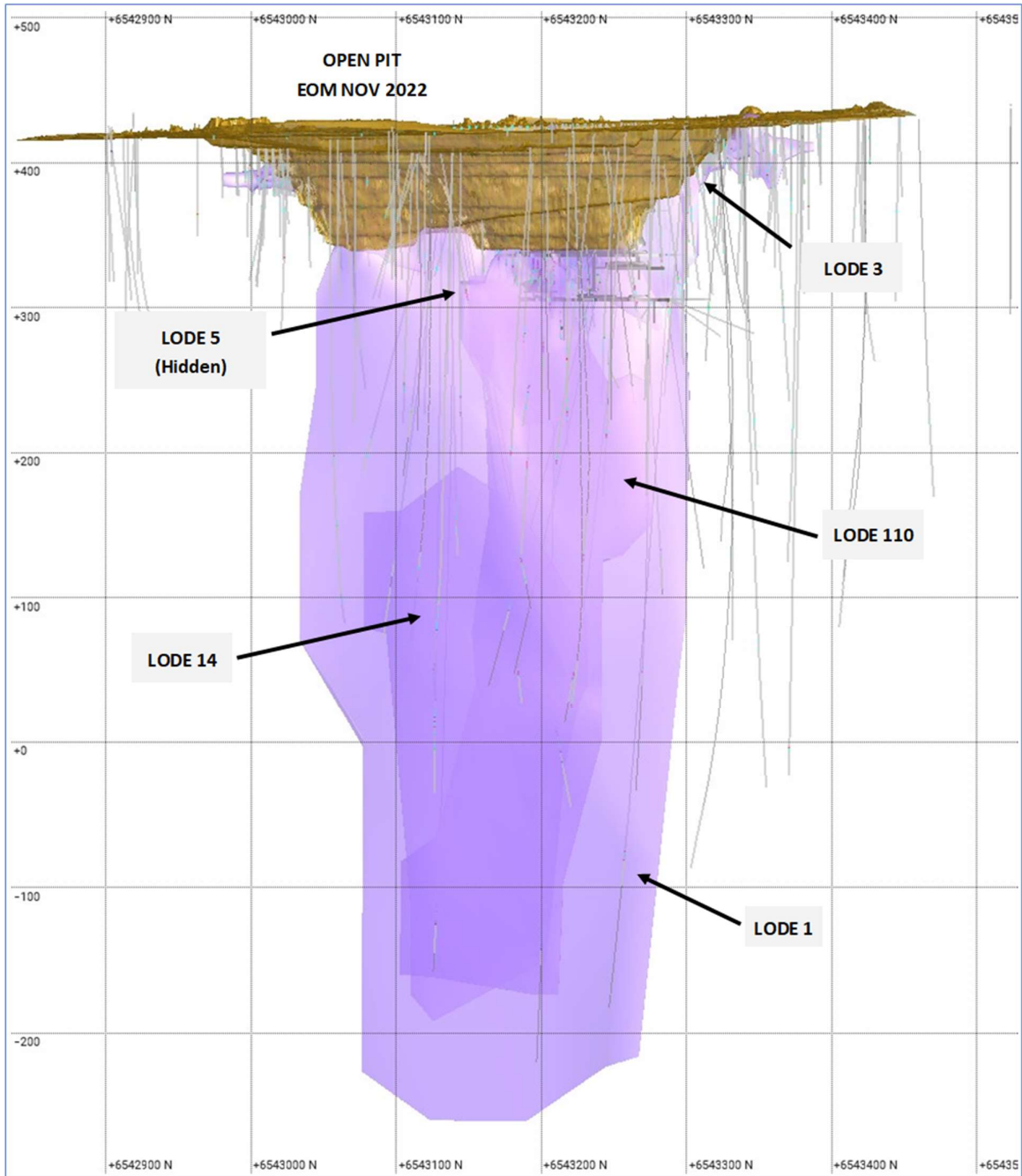

Figure 14-39 Spargos mineralisation and completed open pit – long-section view looking west



14.4.1.4 Statistical Analysis and Compositing

The wireframes of the mineralised lodes were used to code the drill hole intersection into the database to allow identification of the resource intersections. GEOVIA Surpac™ was then used to extract downhole composites within the different resource domains. Holes were composited to 1 m with a minimum of 0.25 m. The composites were checked for spatial correlation with the objects, the location of the rejected composites, and zero composite values. Individual composite files were created for each of the domains in the wireframe models.

A CV greater than 1.5 generally indicates that the data do not have a normal distribution. As the CV increases, so do the positive skew and the number of high outliers. To assist in the selection of appropriate top-cuts, the composite data were loaded into Supervisor software and histograms and probability plots were generated for each domain. Each domain was analysed individually, reviewing percentile charts, log probability plots and histograms to determine any points of distribution decay or disintegration. Analysis of each domain showed that most required capping and these values ranged from 8 g/t to 250 g/t. A summary of Au statistics for individual lodes is shown in Table 14-44.

Table 14-44 Spargos gold deposit summary statistics

Domain	Count	Min	Max	Mean	CV	Top-Cut			No. Comps Top-Cut
						Value	Mean	CV	
1	7,187	0.01	590	2.65	4.29	70	2.37	2.52	22
3	936	0.01	21.7	0.87	1.6	8	0.84	1.22	5
4	43	0.07	83.1	6.17	2.4	20	3.64	1.55	4
5	33	0.04	6.04	1.05	1.3	-	-	-	-
6	97	0.06	15.01	1.44	1.7	10	1.34	1.45	3
7	30	0.03	5.04	1.27	1.15	-	-	-	-
8	60	0.04	14	1.35	1.72	-	-	-	-
9	63	0.1	28.3	1.56	2.28	10	1.27	1.2	1
10	8	0.12	15.7	2.75	1.8	10	2.04	1.51	1
11	123	0.01	7.35	0.65	1.23	-	-	-	-
12	171	0.01	50.8	1.64	2.62	20	1.46	1.71	1
13	85	0.01	15.4	1.09	1.81	10	1.02	1.51	1
14	67	0.01	35.3	2.17	2.19	20	1.94	1.69	1
15	85	0.01	7.43	0.86	1.44	-	-	-	-
110	595	0.04	98.26	8.18	1.01	70	8.12	0.94	2
111	36	1.56	44.2	7.99	0.9	25	7.46	0.64	1
112	392	0.25	118	10.76	0.94	60	10.61	0.84	1
120	417	0.11	590	18.1	2.32	250	17.29	1.93	1

14.4.1.5 Density

Average bulk density values were assigned to each regolith type and to individual lithologies within each regolith type. Measurements conducted by Barra Resources in 2008 totalled 320 and were confined to fresh material. Values applied to fresh material vary from 2.7 t/m³ to 3.0 t/m³ dependent on lithology type and have been assigned based on the determined values. For oxide and transitional material, values have been assumed and are based on values applied at the nearby Mincor Widgiemooltha Gold Operation. A value of 2.0 t/m³ was applied to oxide

material, and 2.3 t/m³ to transitional material. Underground backfill material was assigned an assumed value of 1.8 t/m³.

14.4.1.6 Variography

Understanding the grade continuity and determining its extent and orientation is achieved through interpreting and modelling the experimental variogram. The experimental variogram requires sufficient sample data to provide a reliable measure of the grade continuity. Relevant lodes were modelled using Supervisor software using a log transformation.

A two-structured nested spherical model was found to model the experimental variograms reasonably well. The downhole variogram provides the best estimate of the true nugget value which was generally low to moderate for Au (from 0.18 to 0.42). Variogram parameters were applied to the minor lodes where there were insufficient samples to model.

The variogram model for Domain 1 is shown in Figure 14-40 and the interpolation parameters are summarized in Table 14-45.

Figure 14-40 Variogram models for Domain 1

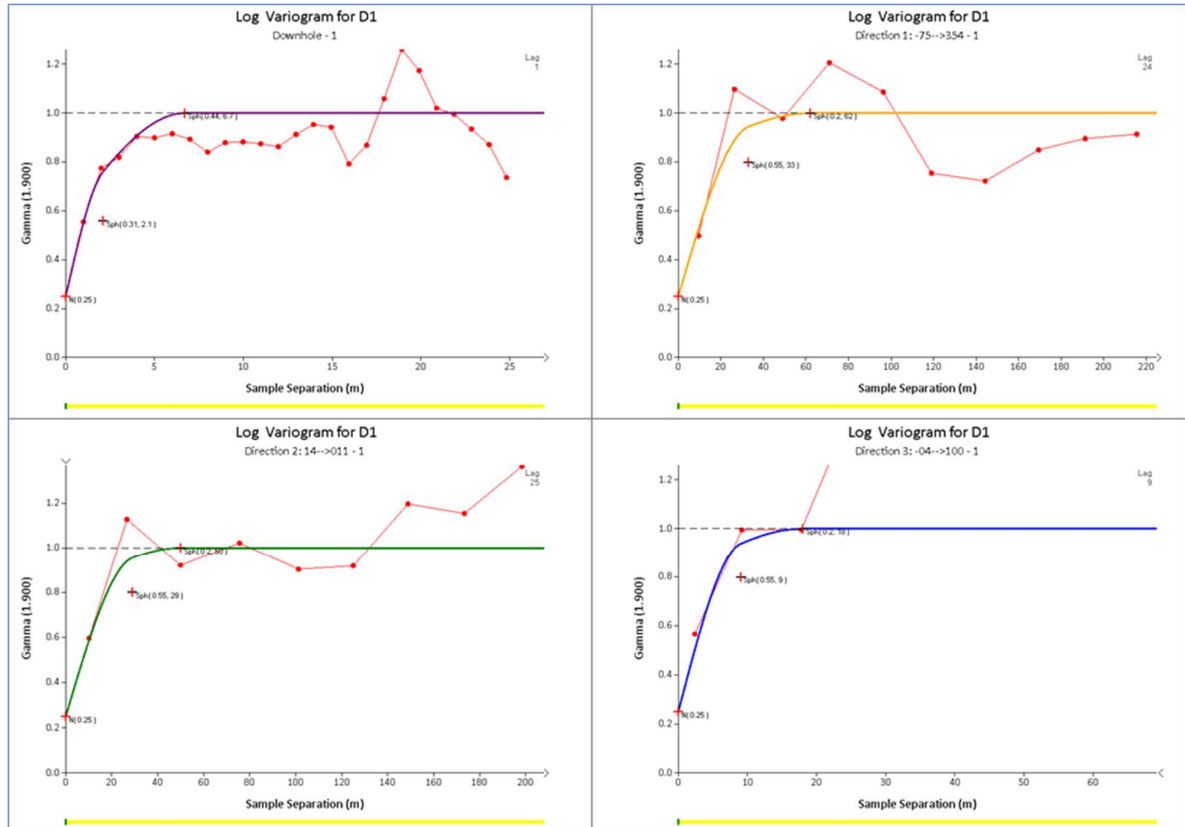

Table 14-45 Variogram parameters summary

Domain	c0	Spherical 1				Spherical 2			
		c1	a1	semi1	minor1	c2	a2	semi2	minor2
1	0.25	0.55	33	1.1	3.7	0.2	62	1.2	3.4
3	0.42	0.45	13.3	1.3	1.7	0.13	27.7	1.4	1.8
110	0.18	0.32	40	1	1.2	0.5	100	1.6	2.5

14.4.1.7 Block Model and Grade Estimation

The existing block model was created using GEOVIA Surpac™ to encompass the full extent of the deposit. The extension of the lodes at depth required the block model to be extended in the vertical. The parent block size of 5 m NS x 5 m EW x 2.5 m vertical with sub-blocking to 1.25 m x 0.625 m x 2.5 m was retained. The selected parent block size was based on the results of a kriging neighbourhood analysis (KNA) while the small sub-block size was necessary to provide sufficient resolution to the block model.

Ordinary kriging (OK) was used for the gold grade interpolation as it allowed the measured spatial continuity to be incorporated into the estimate and results in a degree of smoothing which is appropriate for the disseminated nature of the mineralisation. An ID³ interpolation was used to estimate arsenic for all lodes, and as a check estimate for the kriged gold estimate.

The wireframes were used as a hard boundary for the grade estimation of each domain. That is, only grades inside each lode were used to interpolate the blocks inside the lode. An 'ellipsoid' search orientated to reflect the geometry of the individual lodes was used to select data for interpolation. The search ellipse was based on the kriging parameters but adjusted to reflect the local changes in each of the minor lodes.

Three estimation passes were used for the interpolations with parameters based on the variogram models. A fourth pass was required for the main lode 1 to provide an estimate to the deepest blocks. A first pass search radius ranging from 20 m to 40 m was used and these search distances were doubled for each successive pass. A fourth pass search of 240 m was required to provide a block estimate for the deepest extents of the main lode (Domain 1). A minimum of 10 samples was required in the first pass and this was reduced to 6 and then 2 for each successive pass. A limit of four samples per drill hole was imposed.

14.4.1.8 Model Validation

The following three-step process was used to validate the estimate through the entire deposit:

- A visual assessment was completed by slicing sections through the block model in positions coincident with drilling.
- A quantitative assessment was completed by comparing the average grades of the composite file input against the block model output for all the lodes.
- For the main domains, trend swath plots were generated in various orientations across strike, along strike and at elevation.

The validation indicates that the mineral resource model replicates the source input data well.

14.4.1.9 Mineral Resource Classification

The Spargos Mineral Resource was classified in accordance with the JORC Code 2012 guidelines. A reconciliation of this reporting and the CIM Definition Standards (2014) by the Qualified Person shows no material differences.

The deposit has been classified as Indicated or Inferred Mineral Resource based on a combination of quantitative and qualitative criteria which included geological continuity and confidence in volume models, data quality, sample spacing, lode continuity and estimation parameters.

The Indicated portion of the Mineral Resource was defined across the main lodes through areas that had generally been filled in the first or second estimation pass and were defined by RC and

diamond holes on spacings ranging from 30 m and up to 70 m down dip. Digitised strings were used to form regular shapes to code these areas.

The minor lodes and the down dip extents of the main lode were classified as Inferred Mineral Resource.

The block model coloured by classification is shown in Figure 14-41.

Figure 14-41 Spargos block model coloured by resource classification – long-section looking west

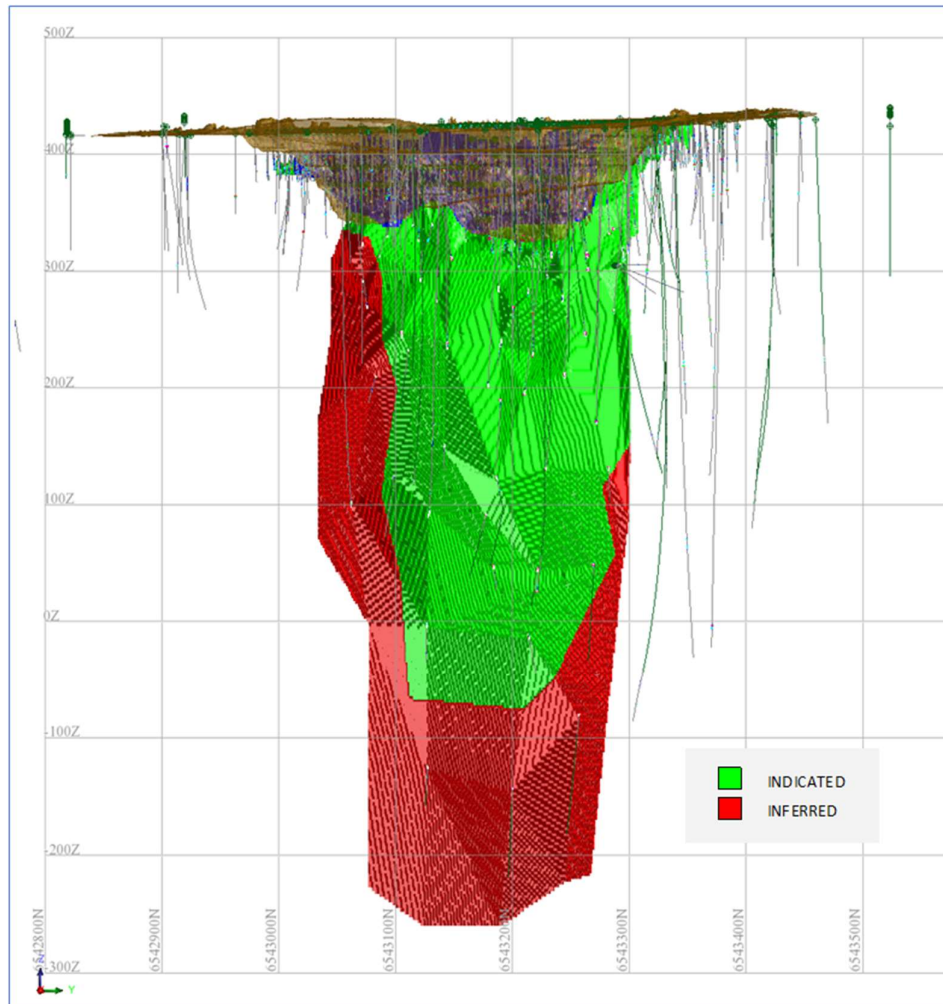

14.4.1.10 Mineral Resource Statement

The Mineral Resource Statement presented herein sets out the Gold Mineral Resource estimate prepared in accordance with the Canadian Securities Administrators' National Instrument 43-101 and Form 43-101F. The Mineral Resource estimate as set out in Table 14-46 is effective as of September 30, 2023. The Mineral Resource at the Spargos gold deposit has been reported using 1.6 g/t Au cut-off for the remaining underground material and has been depleted for open pit mining.

Table 14-46 Spargos Depleted Mineral Resource using 1.6 g/t Au cut-off

MRE Summary	Measured			Indicated			Measured & Indicated			Inferred		
	kt	g/t	koz	kt	g/t	koz	kt	g/t	koz	kt	g/t	koz
Spargos	-	-	-	615	4.6	92	615	4.6	92	480	3.6	56

- 1) Mineral Resources that are not Mineral Reserves do not have demonstrated economic viability. There is no certainty that all or any part of the Mineral Resources estimated will be converted into Mineral Reserves.
- 2) The Measured and Indicated Mineral Resources are inclusive of those Mineral Resources modified to produce Mineral Reserves.
- 3) The Mineral Resource estimates include Inferred Mineral Resources that are normally considered too speculative geologically to have economic considerations applied to them that would enable them to be categorized as Mineral Reserves. There is also no certainty that Inferred Mineral Resources will be converted to Measured and Indicated categories through further drilling, or into Mineral Reserves once economic considerations are applied.
- 4) The Gold Mineral Resources are estimated using a long-term gold price of US\$1,700/oz with a USD:AUD exchange rate of 0.70.
- 5) The Gold Mineral Resource was reported using a 1.6 g/t cut-off grade taking into account variable operational costs associated with the Higgsவில் Underground operations.
- 6) Classification is according to JORC Code and CIM Definition Standards Mineral Resource classification categories.
- 7) The Mineral Resource is depleted for mining to September 30, 2023.
- 8) To best represent 'reasonable prospects of eventual economic extraction', the Mineral Resource for open pits has been reported within an optimized pit shells at A\$2,429/oz (US\$1,700/oz).
- 9) Mineral Resource tonnage and contained metal have been rounded to reflect the accuracy of the estimate, and numbers may not add due to rounding.
- 10) Gold Mineral Resource estimates were prepared under the supervision of Qualified Person S. Devlin, FAusIMM (Chief Geological Officer, Karora Resources).

14.4.2 Chalice

14.4.2.1 Summary

The Chalice gold deposit is located within the Higgsவில் Regional Exploration Area defined by Karora which includes the Higgsவில் Gold Operations. The deposit is located approximately 130 km south of Kalgoorlie, and 22 km WSW of Higgsவில் Mining Centre off the Coolgardie-Norseman Highway. The deposit is situated between the gold mining centres of Norseman and St Ives. It lies to the west of the Zuleika Shear, towards the southern end of the Norseman-Wiluna Greenstone Belt of the Archaean Yilgarn Craton.

The Chalice Deposit was discovered by the Widgimooltha Joint Venture (Resolute Samantha 70%, Great Southern Mines 15%, and Geographe Resources 15%). Extensive exploration was undertaken on the Chalice Trend by Resolute during the 1990s which led to the discovery of the Chalice Deposit. The discovery resulted from RC drilling of a soil geochemical anomaly, peaking at 360 ppb Au.

The deposit was mined by Resolute from August 1995 to June 1999 and produced 2.9 Mt @ 5.6 g/t Au for 517,000 oz from the open pit and 0.2 Mt @ 5.5 g/t Au for 39,000 oz from underground immediately below the north end of the pit. Further resources were identified beneath the mine workings and remain in-situ.

Alacer Gold Corp mined continuously until mid-2013 when Metals X acquired the project, but the mine closed in September 2014 after unsuccessful attempts to extend the mine life.

The local geology is characterised by NNW-striking and west-dipping intercalated mafic and ultramafic volcanic rocks that are metamorphosed to mid-amphibolite facies grade. This

sequence is bounded to the west and east by thick granitic bodies of the Boorabin Batholith and Pioneer Dome Batholith, respectively. Intruding the 'greenstone' sequence is a complex network of multi-generational granite, pegmatite and porphyry bodies. The dominant unit that hosts gold mineralisation is a fine grained, weakly to strongly foliated amphibole-plagioclase amphibolite. Two major and one minor ultramafic units occur as discontinuous members throughout the deposit. Four generations of granitic dyke intrude the lithostratigraphic sequence. The mineralisation is characterised by strong diopside-hornblende-albite alteration with associated pyrite/pyrrhotite sulphides. Mineralisation occurs with highly foliated and folded host rock with width varying up to 50 m.

The current Chalice Mineral Resource was completed by the previous owner Metals X in November 2014 (Corin et al., 2014). Chalice is divided into six main resource areas with a total of 75 different wireframed lodes/sub-lodes with differentiation based on the dominant style of mineralisation and the relative spatial distribution of each. The mineralised envelopes were intended to be modelled using nominal gold grade of 0.8 g/t Au envelope.

14.4.2.2 Drilling and Sample Data

The Chalice Mineral Resource estimate was completed using historical and recent drill results of predominantly diamond drilling methods. Face channel samples and reverse circulation drill holes were also included, making up 30% of the data.

14.4.2.3 Modelling Domains

Wireframes were created for the principal lithological domains, including the western granite, the western ultramafic, ultramafic dykes and felsic intrusive, and the faults.

Mineralisation wireframes were divided into six main resource areas with a total of 75 individual resource domain wireframes used in estimate. The differentiation of areas was based on the dominant style of mineralisation and the relative spatial distribution of each. The initial interpretation was completed on 1:250 scale hardcopy cross-sections, long-sections and level plans, and then digitised into the Vulcan 3D modelling package.

The mineralised domains were based predominantly on a nominal gold grade of 0.8 g/t Au, with structure (chaotic folding and foliation), amount of diopside and alteration taken into consideration.

The deposit is subdivided into four principal zones: Kronos, Atlas, Grampians and Olympus. Kronos consists of nine lodes up dip from Atlas. Atlas consists of a single domain with higher grade subdomains. Grampians consists of two wireframes, one for the core folded mineralisation and one for a lower grade halo. These were then sub-domained into nine zones, one core and one halo domain for each of the mineralised limbs. Olympus consists of two main domains, 14 footwall domains, and one hanging-wall domain. Two halos were also created around the lodes to interpolate grade into areas not constrained by wireframes which contained sub-economic or isolated occurrences of gold mineralisation, as defined by drill holes.

The four principal domains at Chalice are shown in Figure 14-42.

Figure 14-42 Chalice mineralised domains – long-section looking west

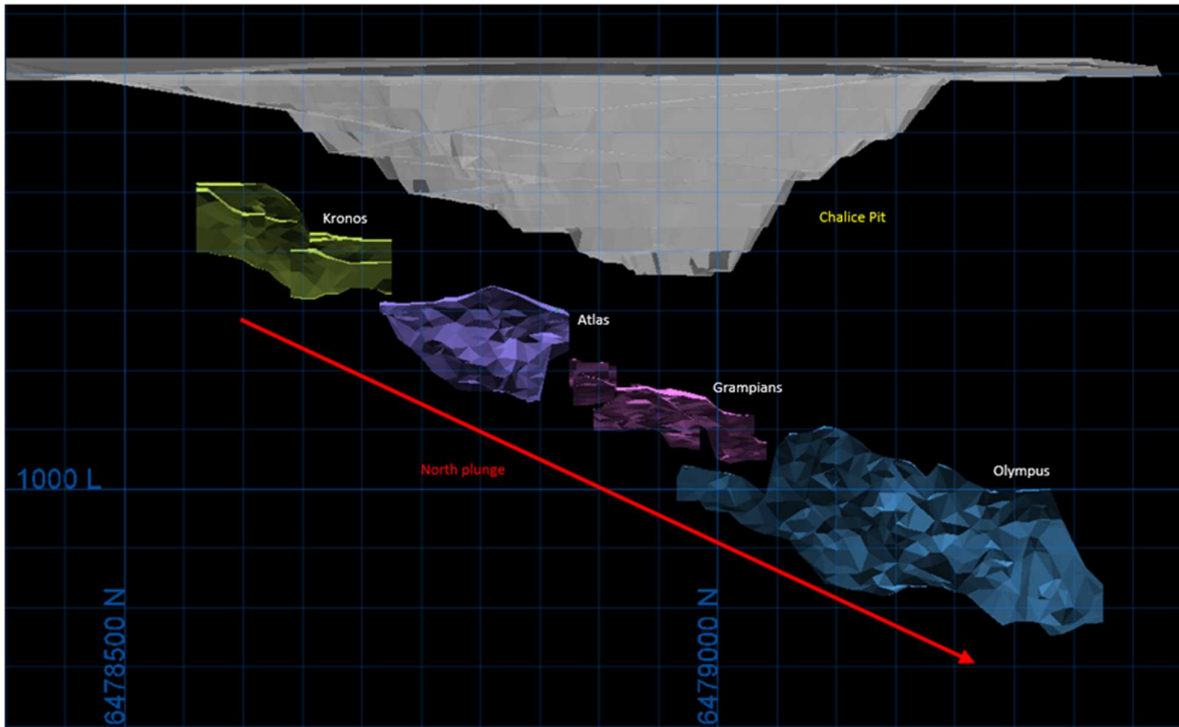

No oxidation surface has been created for the Chalice Deposit. In general, the top of the mineralisation is greater than 90 m below the surface and the top of fresh rock is generally logged as less than 75 m below surface, as such all modelled mineralisation occurs in fresh rock.

14.4.2.4 Statistical Analysis and Compositing

An analysis of the raw sample length statistics was undertaken to determine an appropriate composite interval length. The analysis was undertaken on all samples contained within mineralised wireframes. A composite length of 1 m was used as approximately 80% of the data was sampled at 1 m intervals.

Statistical analysis of the composite data was completed for all domains. In some instances, domains were grouped by orientation prior to analysis.

Top-cuts were applied to most domains to reduce the influence of extreme grades during grade estimation. For analysis, some domains were grouped by statistical and geological similarities and the same top-cut applied to all domains in that group. Where enough data was available, domains were assessed separately. Top-cuts were determined by assessing normal and log-histograms for extreme values and using a combination of mean variance plots and population disintegration techniques. Top-cuts selected for the various domains are shown in Table 14-47.

Table 14-47 Top-cut summary

Zone	Au g/t
Atlas	25
Grampians	50
Olympus Steep Domain 201	80
Olympus Steep Domain 210	250
Olympus Steep HW + FW lodes	35
Olympus Shallow Domain 221	50
Olympus Shallow HW + FW lodes	20
Olympus Shallow Domain 229	25
Olympus Lower FW	25
Kronos	17
Ultramafic	12
Pit	60

14.4.2.5 Density

Bulk density was assigned to lithology at each domain area and these values were based on 69 samples taken from the various mineralised domains and different lithologies in June 2011. For these tests, samples were selected to cover lithology type and mineralisation from a geometrically dispersed range across the deposit. Individual unbroken half core samples of approximately 30 cm lengths were randomly selected from within specified metre intervals. Samples were sent to the Genalysis Laboratory in Kalgoorlie, where mass and volumes (by water immersion) were recorded, and bulk density calculated. The densities assigned to the Chalice model are summarised in Table 14-48.

Table 14-48 Bulk densities used in the Chalice model

Lithology	Average Density (t/m ³)
Olympus/Grampians	3.03
Atlas	3.08
Amphibolite	3.02
Ultramafic	2.74
Felsic Intrusive	2.61

14.4.2.6 Variography

Directional variograms were modelled with a normal scores transformation of the data performed converting skewed grade distributions to a standard normal distribution, thereby limiting the effect of extreme grades. The normal scores variogram models were back transformed for use in the estimation. Where appropriate, domains of similar orientation, geology and statistics were grouped to bulk out small populations for analysis (Table 14-49).

Moderate to high nuggets were determined for most lodes/domains and structure ranges up to approximately 50 m.

Table 14-49 Variogram model parameters for the Chalice estimation

Orebody	Lode	Domains		Directions	C ₀	Structure 1			Structure 2		Structure 3		Rotation	
		Used for Analysis	Analysis Applied to			C ₁	A ₁	C ₂	A ₂	C ₃	A ₃			
Atlas	Atlas	101	102 103	Dir 1	0.49	0.31	30	0.2	40			X	102	
				Dir 2			6		31			Y	54	
				Dir 3			27		28			Z	166	
Olympus	Olympus Steep	201	202 203 204 205 206 207 208 209	Dir 1	0.59	0.3	36	0.11	41			X	166	
				Dir 2			6		25			Y	18	
				Dir 3			13		19			Z	116	
	Olympus Steep	210			Dir 1	0.47	0.44	20	0.08	29			X	18
					Dir 2			6		18			Y	40
					Dir 3			22		24			Z	-123
	Olympus Shallow	221	229		Dir 1	0.25	0.57	19	0.18	25			X	133
					Dir 2			17		18			Y	28
					Dir 3			11		13			Z	131
	Olympus Shallow	225	222 223 224 226 227 228		Dir 1	0.5	0.2	36	0.3	45			X	50
					Dir 2			62		70			Y	35
					Dir 3			1		6			Z	-150
	Olympus Lower FW	247	241 242 243 244 245 248 249 251 253		Dir 1	0.48	0.11	41	0.42	49			X	3
					Dir 2			21		40			Y	4
					Dir 3			16		23			Z	-120
	Olympus Lower FW	250	246 252		Dir 1	0.51	0.3	2	0.19	15			X	152
					Dir 2			2		13			Y	12
					Dir 3			1		8			Z	158
	Pit	Chalice Pit	403	401 402 404 405 406 407 408 409 410 411	Dir 1	0.51	0.36	11	0.13	54			X	73
					Dir 2			15		34			Y	65
					Dir 3			14		24			Z	-169
	Gramplains	Gramplains	301	302 303 305 306 307 308 309 310 311	Dir 1	0.1	0.41	4	0.49	35			X	106
					Dir 2			10		18			Y	43
					Dir 3			3		6			Z	165
Kronos	Kronos	603	601 602 604 605 606 607 608 609	Dir 1	0.41	0.28	28	0.31	40			X	176	
				Dir 2			20		38			Y	3	
				Dir 3			2		5			Z	140	

14.4.2.7 Block Model and Grade Estimation

Metals X modelled the Chalice deposit utilising Vulcan software. A maximum cell size of 10 mX x 10 mY x 10 mZ was selected with sub-cells of 1 m x 1 m x 1 m.

Ordinary kriging (OK) interpolation was used for the gold grade interpolation for most of the domains; however, the inverse distance squared (ID²) interpolation was used to estimate gold for the Ultramafic lodes due to the small volumes and the limited number of samples within each.

A three-pass strategy was used, with the first pass major search distance set to 30 m. This was doubled for each successive pass. A minimum of 8 and a maximum of 30 composites was typically used, although for some domains the minimum was reduced as low as 2 or 3.

14.4.2.8 Model Validation

Visual and statistical validation of the grade estimates was completed, including the following:

- Review of the block estimate and the composite data in cross-section, long-section and plan views.
- Comparison of composite grades and block model grades broken down into northing and Elevation zones.

- Comparison of the mean grade of the contributing composites versus the mean grade of the estimate.

Swath plots were generated to compare the average grades assigned to blocks against the input composite grades.

14.4.2.9 Mineral Resource Classification

The Chalice Mineral Resource was classified in accordance with the JORC Code 2012 guidelines. A reconciliation of this reporting and the CIM Definition Standards (2014) by the Qualified Person shows no material differences.

The deposit has been classified as Measured, Indicated or Inferred Mineral Resource based on a combination of confidence in the tonnage/grade estimations, reliability of input data, confidence in continuity of geology and metal values, and the quality, quantity and distribution of the data.

The Measured portion was confined to areas between completed development horizons.

The Indicated portion of the Mineral Resource was defined across all areas defined within the drilled-out area.

The remaining areas were classified as Inferred Mineral Resource.

Domains defined by single drill intersections were considered to have mineral potential and were not reported.

The block model coloured by classification is shown in Figure 14-43.

Figure 14-43 Chalice block model coloured by classification (red=Measured, green=Indicated, blue=Inferred, cyan=mineral potential)

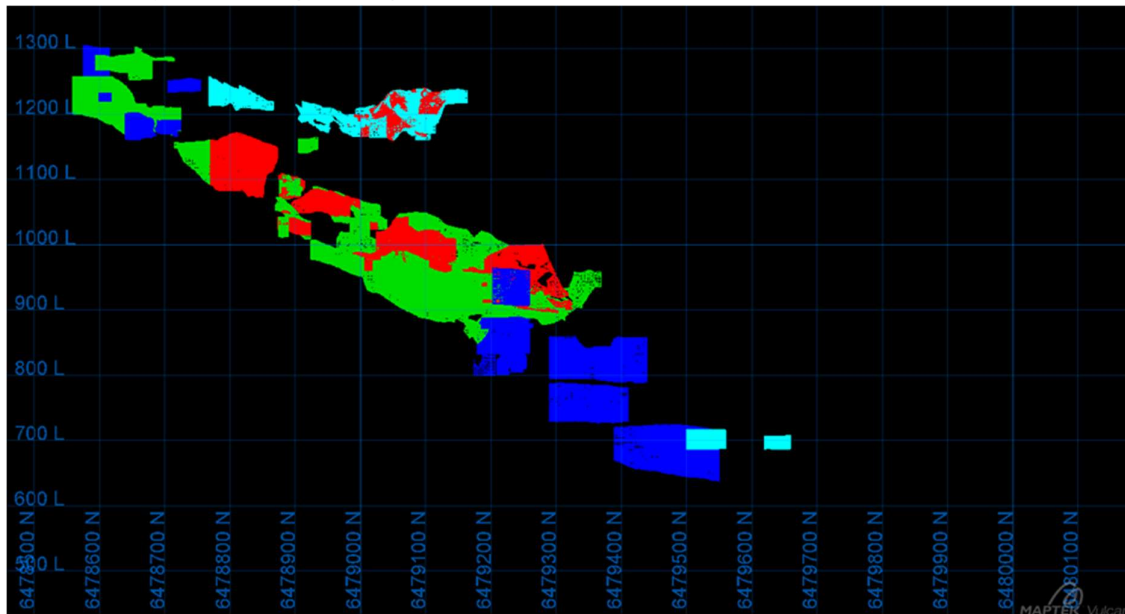

14.4.2.10 Mineral Resource Statement

The Mineral Resource Statement presented herein sets out the Gold Mineral Resource estimate prepared in accordance with the Canadian Securities Administrators' National Instrument 43-101 and Form 43-101F. The Mineral Resource estimate as set out in Table 14-50 is effective as of September 30, 2023. The Mineral Resource at the Chalice gold deposit has been reported using a 1.3 g/t Au cut-off for the remaining underground material and has been depleted for all mining. Areas considered sterilised by historical mining activities were removed from the Mineral Resource estimation.

Table 14-50 Chalice Depleted Mineral Resource using 1.3 g/t Au cut-off

MRE Summary	Measured			Indicated			Measured & Indicated			Inferred		
	kt	g/t	koz	kt	g/t	koz	kt	g/t	koz	kt	g/t	koz
Chalice	406	3.2	42	1,120	2.6	94	1,526	2.8	135	655	2.6	56

- 1) Mineral Resources that are not Mineral Reserves do not have demonstrated economic viability. There is no certainty that all or any part of the Mineral Resources estimated will be converted into Mineral Reserves.
- 2) The Measured and Indicated Mineral Resources are inclusive of those Mineral Resources modified to produce Mineral Reserves.
- 3) The Mineral Resource estimates include Inferred Mineral Resources that are normally considered too speculative geologically to have economic considerations applied to them that would enable them to be categorized as Mineral Reserves. There is also no certainty that Inferred Mineral Resources will be converted to Measured and Indicated categories through further drilling, or into Mineral Reserves once economic considerations are applied.
- 4) The Gold Mineral Resources are estimated using a long-term gold price of US\$1,700/oz with a USD:AUD exchange rate of 0.70.
- 5) The Gold Mineral Resource was reported using a 1.3 g/t cut-off grade
- 6) Classification is according to JORC Code and CIM Definition Standards Mineral Resource classification categories.
- 7) The Mineral Resource is depleted for mining to September 30, 2023.
- 8) To best represent 'reasonable prospects of eventual economic extraction', the Mineral Resource for open pits has been reported within an optimized pit shells at A\$2,429/oz (US\$1,700/oz).
- 9) Mineral Resource tonnage and contained metal have been rounded to reflect the accuracy of the estimate, and numbers may not add due to rounding.
- 10) Gold Mineral Resource estimates were prepared under the supervision of Qualified Person S. Devlin, FAusIMM (Chief Geological Officer, Karora Resources).

14.4.3 HGO Greater Paleochannels

The Higginsville Greater area includes those deposits outside a 10 km radius from the Higginsville Mill. Two paleochannel gold deposits occur within this greater area, Nanook and Wills.

14.4.3.1 Nanook Summary

The Nanook Deposit is located approximately 20 km southeast of the Higginsville Mill. The Mineral Resource model was completed by S2 Resources Limited in 2015.

The regional geology of the Nanook deposit is dominated by complexly deformed Achaean greenstone assemblages of the Norseman-Wiluna Greenstone Belt which have been metamorphosed to upper greenschist facies. The major regional structures in the area are the Boulder-Lefroy Fault located approximately 10 km northeast of the project area, the Mission Fault located in the southern portion of the project area, and the Black Knob Fault that transects the central portion of the project. Nanook is a paleoplacer deposit derived from mineralised

Archean basement rock and consists of eluvial/alluvial basal quartz sands and rubble concealed under the tertiary-aged sediments of Lake Cowan.

14.4.3.2 Drilling and Sampling Data

The Nanook drill hole database created by S2 is dated April 30, 2016 and consists of 1,387 drill holes for 62,801 m. The database includes information for AC, RC and diamond drilling as summarised in Table 14-51 and displayed in Figure 14-44.

Table 14-51 Summary of drill hole data used in compilation of Nanook mineral resource estimate

Hole Type	No. of Holes	Total Meters (m)
AC	1,372	60,688
DDH	3	941
RC	12	1,172
Total	1,387	62,801

Figure 14-44 Nanook deposit drill hole plan highlighting mineralised zone

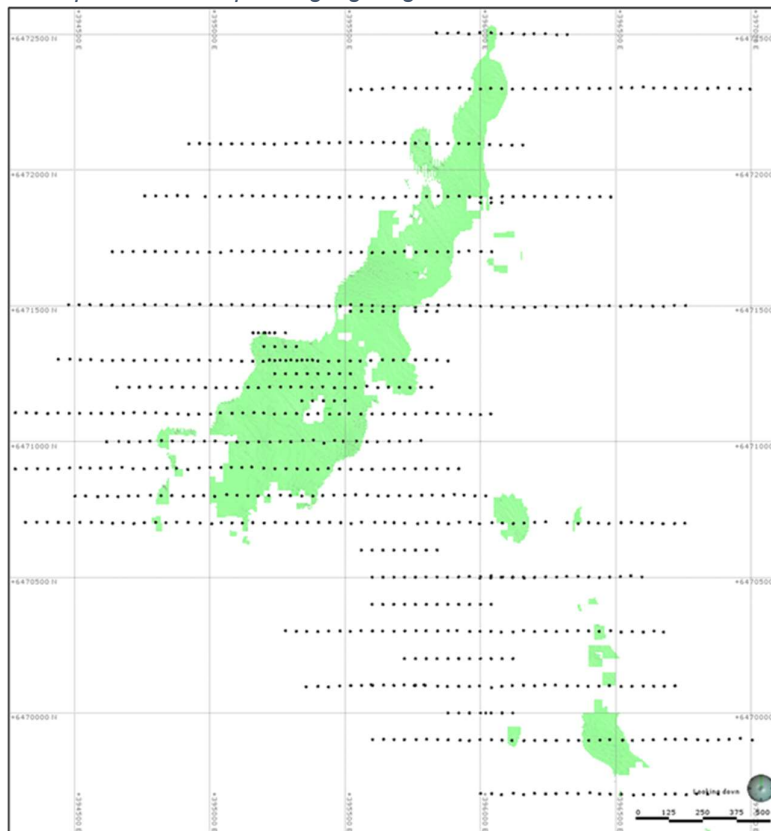

The drill hole database was validated by S2 prior to the resource estimation process, including the following checks:

- Checking for overlapping intervals, irregular downhole surveys, and total depths;
- Obvious survey and/or position errors; and
- Negative grade values representing assays below detection limit which were replaced by 0.005 ppm Au values.

14.4.3.3 Modelling Domains

Nanook is a paleoplacer deposit. It is derived from mineralised Archean basement rock and consists of eluvial/alluvial basal quartz sands and rubble concealed under the tertiary-aged sediments of Lake Cowan.

Implicit modelling via Leapfrog software was employed to generate a geological model. Domains were created based on the logging of the Tertiary-Archean unconformity where transported sediments interface with residual weathered Archean lithologies.

A wireframe was created to encompass the logged mineralised sandy gravel basal lag. A nominal lower cutoff grade of 0.3 g/t was used (Figure 14-45).

Figure 14-45 Section 6,471,300 mN showing mineralisation domain

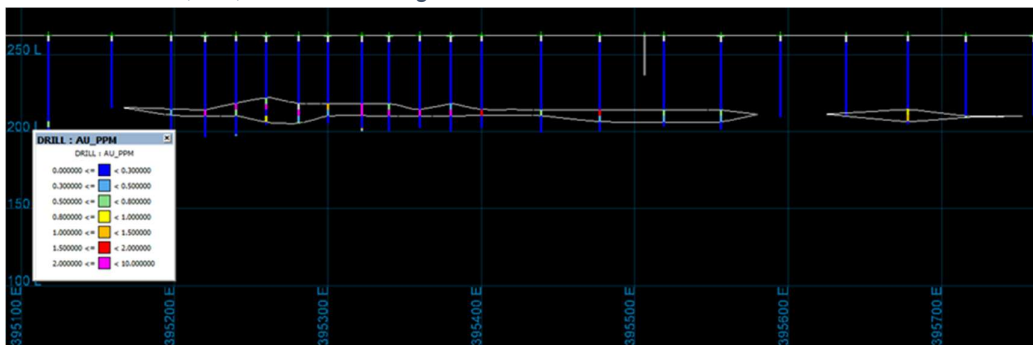

14.4.3.4 Statistical Analysis and Compositing

The drill hole database was coded using the final mineralisation shell. The lengths of the assayed samples coded within the mineralisation wireframes were statistically assessed prior to selecting an appropriate composite length for undertaking statistical analyses, variogram modelling and grade estimation. Summary statistics of the sample length indicates that approximately 16% of the samples were collected at 1 m intervals, 2% of the samples were collected at 2 m intervals, 2% of the samples were collected at 3 m intervals and 80% of the samples were collected at 4 m intervals.

After consideration of relevant factors relating to geological setting and mining, including likely mining selectivity and bench/flitch height, a regular 4 m run length (downhole) composite was selected as the most appropriate composite interval to equalise the sample support. Compositing was broken when the routine encountered a change in flagging (mineralisation shell boundary).

Summary descriptive statistics were generated for gold (Table 14-52). A high maximum grade of 203 g/t Au was noted. The grade distribution is typical for gold deposits of this style and shows a strongly positive skew or near lognormal behaviour (Figure 14-46). The CV is high, and this is consistent with the presence of high outlier grades that potentially require capping for grade estimation.

Table 14-52 Summary statistics of 4 m composites of uncut gold grade (g/t)

Domain	Count	Minimum	Maximum	Mean	Std. Dev.	Variance	CV
100	407	0.001	203	1.35	10.68	114.16	7.91

Figure 14-46 Log histogram of uncut gold grade - Domain 100

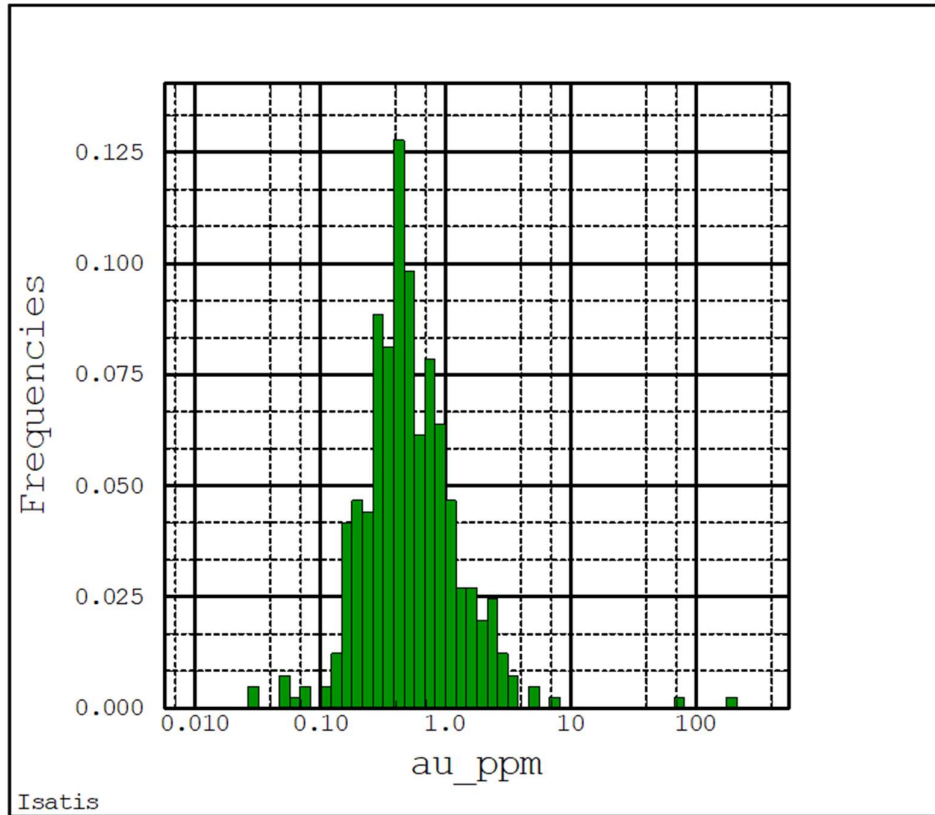

Grade capping was deemed necessary for the domain of interest, due to the high CV of the gold population. The capping value was selected from the inflection point in the log probability plot. The spatial location of the outliers was also taken into consideration when selecting the capping value, whether the outliers were clustered or otherwise. It was determined that such clustering did not occur and therefore a capping value of 8 g/t Au was selected. Two composites were capped to this threshold and the revised statistics are compiled in Table 14-53.

Table 14-53 Revised statistics of the downhole composites with grade capping applied

Domain	Capping value	Capped Count	Uncapped Mean	Capped Mean	Mean reduction
100	8	2	1.35	0.7	-48%

14.4.3.5 Density

There are no bulk density measurements for Nanook. Bulk densities were assigned uniformly below the topography with a value of 1.8 t/m³.

14.4.3.6 Variography

Grade variography was generated to enable grade estimation using the OK interpolation method. In addition, Gaussian variograms were also examined. Grade variography was found to be unstable with no clear directions of anisotropy. Additionally, the deposit averages approximately 4 m in true thickness; therefore, downhole variography was not possible due to the majority 4 m downhole sample length. An omnidirectional Gaussian variogram was modelled and back transformed to the raw data for the purpose of grade estimation. Back-transformed grade variography showed moderate structure. One spherical model and an

exponential model were fitted to the experimental variogram, with the variogram exhibiting a high relative nugget effect of 53%. The short-range structure (spherical), which was modelled with a range of 60 m, accounts for 28% of the total variance and the overall range fitted was 400 m (Figure 14-47 and Table 14-54).

Overall, the grade variogram as presented cannot be considered of high quality due to the unstable characteristics of the calculated raw data variogram (high degree of sensitivity to input parameters). Potential causes may be data configuration, sampling method, 3D geometry of the mineralised bodies and grade variability within the mineralised bodies. Further drilling and/or domaining may be required to determine a resolution.

Figure 14-47 Variogram model – Domain 100

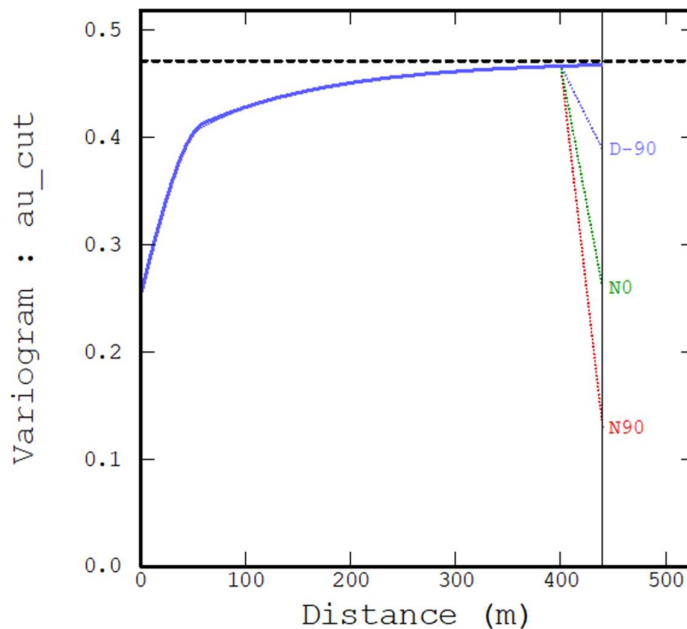

Table 14-54 Back-transformed variogram model parameters - Domain 100

Variable	Nugget (C0)	Structure 1		Structure 2	
		Sill 1 (C1)	Range (m)	Sill 2 (C2)	Range (m)
Gold (Au g/t)	0.25	0.128	60	0.09	400

14.4.3.7 Block Model and Grade Estimation

A 3D block model was created using Vulcan mining software. The parent block size was set to 25 mE x 25 mN x 4 mRL (based on the average drill spacing) which was sub-blocked down to 5 mE x 5 mN x 1 mRL to ensure adequate volume representation. The model covered all the interpreted mineralisation domains and included suitable additional waste material to allow for pit optimisation studies (Table 14-55).

Table 14-55 Nanook block model definition parameters

Parameters	Northing (Y)	Easting (X)	RL (Z)
Min. Coordinates	6,469,300	394,500	180
Max Coordinates	6,472,700	397,200	276
Block size (m)	25	25	4
Sub Block size (m)	5	5	1
Rotation (° around axis)	0°	0°	0°

An ordinary kriging interpolation method was used to estimate the gold grade in the block model using the modelled variogram parameters. Kriging neighbourhood analysis was performed in Isatis software to define the search distance and min/max samples to be used in the estimate (Table 14-56).

Table 14-56 Estimation parameters for gold estimation

Domain	Sample Search Orientation			Sample Search Distance			Numbers of Samples		Maximum Per Drill Hole
	Major	Semi-Major	Minor	Major	Semi-Major	Minor	Min.	Max.	
Pass1	0/0	0/90	90/0	150	150	25	8	12	-
Pass2	0/0	0/90	90/0	500	500	50	8	12	-

Hard domain boundaries were used for the estimation throughout. The search ellipsoid was horizontally orientated and parallel to the mineralisation. A two-pass estimation strategy was used, applying a progressively expanded and less restrictive sample search to the successive estimation pass, and only considering blocks not previously assigned an estimated grade. Gold grades were estimated into parent blocks with discretisation set to 3 mX x 3 mY x 3 mRL.

14.4.3.8 Model Validation

All relevant statistical information was recorded to enable validation and review of the OK estimates, including the following:

- Number of samples used per block estimate;
- Average distance to samples per block estimate;
- Estimation flag to determine in which estimation pass a block was estimated; and
- Number of drill holes from which composite data were used to complete the block estimate.

The estimates were reviewed visually and statistically prior to being accepted. The review included the following activities:

- Comparison of the OK estimate versus the mean of the composite dataset, including weighting where appropriate to account for data clustering.
- Visual checks of cross-sections, long-sections and plans.

Alternative estimates were also completed to test the sensitivity of the reported model to the selected OK interpolation parameters. An insignificant amount of variation was noted in the alternate estimations.

14.4.3.9 Mineral Resource Classification

The resource estimate for the Nanook Deposit has been classified in accordance with the criteria laid out in the JORC Code. Consideration has also been given to the robustness of the various data sources available, including:

- Geological knowledge and interpretation;
- Variogram models and the ranges of the first structure in multi-structure models;
- Drilling density and orientation; and
- Estimation statistics.

Applying these confidence levels of the key criteria and the robustness of the available information, a resource classification of Inferred has been applied to all defined mineralisation.

14.4.3.10 Mineral Resource Statement

The Mineral Resource Statement presented herein sets out the Gold Mineral Resource estimate prepared in accordance with the Canadian Securities Administrators' National Instrument 43-101 and Form 43-101F. The Mineral Resource estimate as set out in Table 14-57 is effective as of September 30, 2023. The Mineral Resource at the Nanook gold deposit has been reported using a 0.5 g/t Au cut-off for open pit material.

Table 14-57 Nanook Mineral Resource using 0.5 g/t Au cut-off

MRE Summary	Measured			Indicated			Measured & Indicated			Inferred		
	kt	g/t	koz	kt	g/t	koz	kt	g/t	koz	kt	g/t	koz
Nanook	-	-	-	-	-	-	-	-	-	625	1.6	31

- 1) Mineral Resources that are not Mineral Reserves do not have demonstrated economic viability. There is no certainty that all or any part of the Mineral Resources estimated will be converted into Mineral Reserves.
- 2) The Measured and Indicated Mineral Resources are inclusive of those Mineral Resources modified to produce Mineral Reserves.
- 3) The Mineral Resource estimates include Inferred Mineral Resources that are normally considered too speculative geologically to have economic considerations applied to them that would enable them to be categorized as Mineral Reserves. There is also no certainty that Inferred Mineral Resources will be converted to Measured and Indicated categories through further drilling, or into Mineral Reserves once economic considerations are applied.
- 4) The Gold Mineral Resources are estimated using a long-term gold price of US\$1,700/oz with a USD:AUD exchange rate of 0.70.
- 5) The Gold Mineral Resource was reported using a 0.5 g/t cut-off grade taking into account variable operational costs associated with the Higginsville Open Pits.
- 6) Classification is according to JORC Code and CIM Definition Standards Mineral Resource classification categories.
- 7) The Mineral Resource is depleted for mining to September 30, 2023.
- 8) To best represent 'reasonable prospects of eventual economic extraction', the Mineral Resource for open pits has been reported within an optimized pit shells at A\$2,429/oz (US\$1,700/oz).
- 9) Mineral Resource tonnage and contained metal have been rounded to reflect the accuracy of the estimate, and numbers may not add due to rounding.
- 10) Gold Mineral Resource estimates were prepared under the supervision of Qualified Person S. Devlin, FAusIMM (Chief Geological Officer, Karora Resources).

14.4.3.11 Wills Summary

The Wills Deposit is a paleochannel deposit located approximately 25 km north of the Higginsville Mill. The deposit extends ENE-WSW for 900 m and occurs at a depth of approximately 20 m below surface. The previous estimate was completed by Karora in 2020. Following an internal review of all data at the deposit, a revised model was completed by Karora in 2023.

14.4.3.12 Drill Hole Data and Sampling

The drill hole database used in the compilation of the resource estimate for Wills was exported from the Karora server on September 4, 2023. A total of 569 drill holes were used in the resource estimate, totalling 24,480 m, and consist predominantly of aircore drill holes. A summary of drilling at the deposit is shown in Table 14-58.

Table 14-58 Drill hole summary at the Wills Deposit

Hole Type	No. of Holes	Total meters (m)
AC	556	21,693
DDH	8	1,848
RC	5	938
Total	569	24,479

14.4.3.13 Modelling Domains

The Wills Prospect was a blind discovery in an area with no records of previous drilling or evidence of historical workings and is masked by an approximately 20 m thick sequence of barren clays. The deposit comprises a coherent blanket of supergene mineralization lying at a depth of between 17 m and 23 m below the surface and appears to define an ENE trend over 1 km in length and is open along strike in both directions and covers widths of up to 200 m. The supergene mineralization is associated with distinct mustard coloured clays containing abundant angular quartz-carbonate-sulphide (oxidized) fragments. The mineralization is coincident with characteristic pathfinder anomalism of silver, arsenic, molybdenum, antimony, lead and tungsten.

The prospect is underlain by northwest-southeast trending ultramafics and porphyries with felsic volcanic to the west and sediments to the east (Figure 14-48). To the north of the deposit a proterozoic dyke cross-cuts east-west and bisects the channel at the eastern limits of the mineralization. The high-grade alluvium mineralisation is located within a trough downstream of the ultramafic. Also downstream of the ultramafics, there are two peripheral (secondary) zones of mineralization slightly above and to the sides of the main channel and which may represent later braiding channels from the main channel.

Figure 14-48 Plan view of geological and mineralisation interpretation of Wills paleochannel deposit

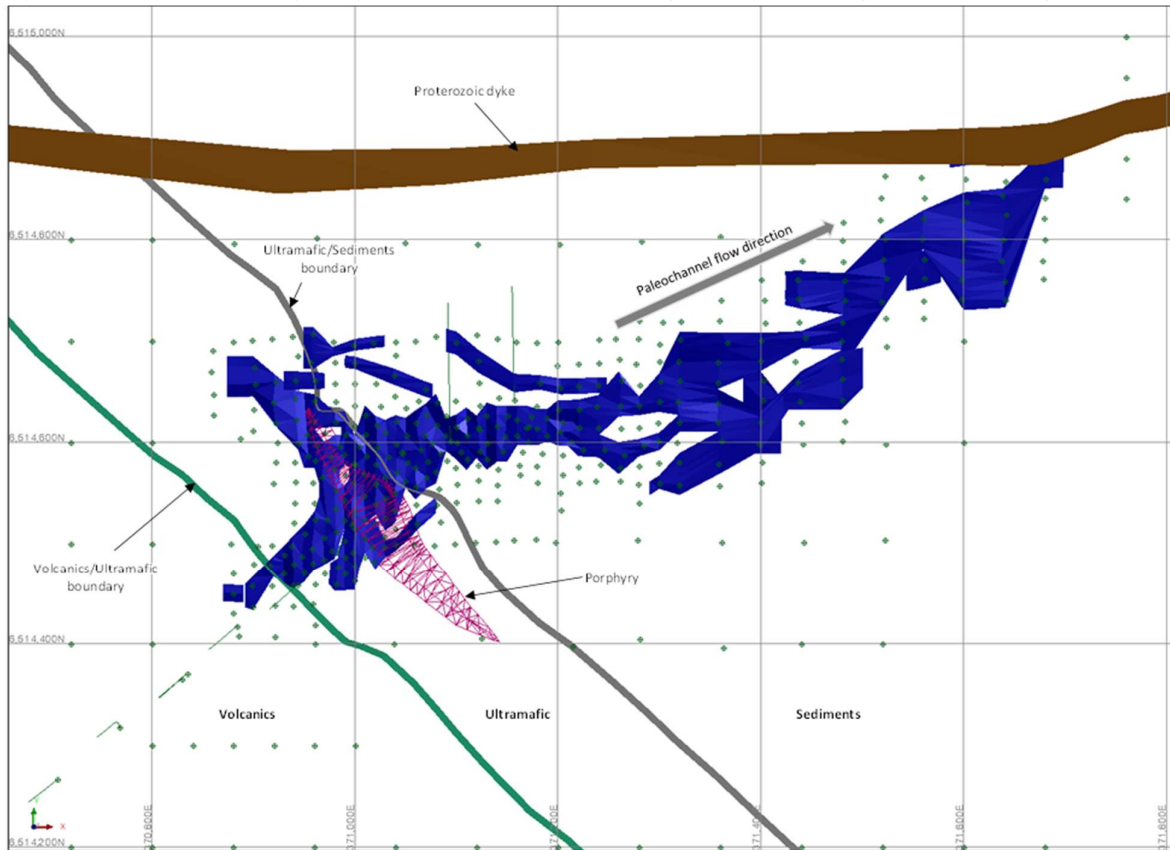

Previous interpretations for Wills (Stanley, 2014) identified three domains, which were based on the geology and weathering characteristics, as follows:

- Main mineralisation associated with the alluvium/basement contact (Domain 101);
- Minor mineralisation associated with alluvium (Domains 102 to 107); and
- Minor mineralisation associated with saprolite (Domains 108 to 111).

The existing interpretation was updated using a visual cut-off at 0.5 g/t to define mineralisation. The main update at Wills focused on the main mineralised zone (Domain 101).

14.4.3.14 Statistical Analysis and Compositing

The updated wireframes were coded in the drill hole database, where 1 m downhole composites were extracted to reflect the predominant sample length which is 1 m. The downhole composites were extracted per individual domain. There were no residuals in the compositing methodology as the samples were generated predominantly from AC drilling sampled at 1 m intervals.

Supervisor software was used to compute the statistics of the 1m composites per mineralised domain. Domains 101 and 1022 contain the most composites and the respective histograms are displayed in Figure 14-49. Summary statistics of all interpreted domains are presented in Table 14-59.

Figure 14-49 Histogram for Domain 101 (left) and Domain 1022 (right)

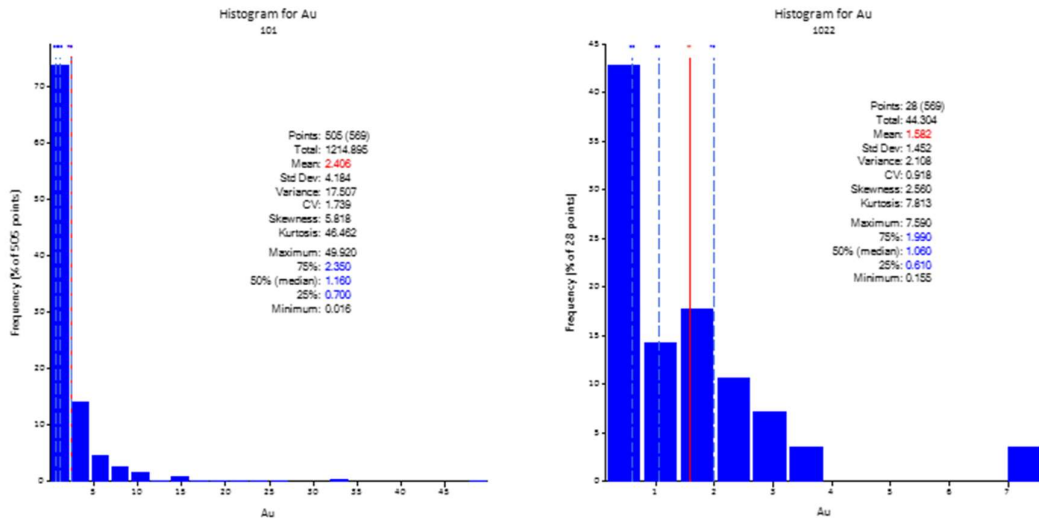

Table 14-59 Summary statistics of all interpreted domains – Wills Deposit

Domain	Samples	Minimum	Maximum	Mean	Standard Deviation	CV	Median
101	505	0.016	49.92	2.41	4.18	1.74	1.16
1021	8	0.65	2.82	1.36	0.65	0.48	1.12
1022	28	0.155	7.59	1.58	1.45	0.92	1.06
1023	3	0.668	1.15	0.89	0.20	0.22	0.76
103	2	0.7	0.83	0.77	0.07	0.09	0.70
104	4	0.85	1.06	0.97	0.09	0.10	0.90
105	2	0.86	2.69	1.78	0.92	0.52	0.86
106	1	1.82	1.82	1.82	0.00	0.00	1.82
107	4	0.6	2.04	1.13	0.59	0.53	0.61
108	2	0.802	0.89	0.85	0.04	0.05	0.80
109	4	0.96	0.96	0.96	0.00	0.00	0.96
110	4	0.68	1.95	1.25	0.46	0.37	1.11
111	2	1.417	2.11	1.76	0.35	0.20	1.42

Composites within Domain 101 display an elevated CV, which suggests the data might require grade capping. The top-cut value was defined based on visual assessment of the histogram, log probability plot and the spatial location of the outliers. The Domain 101 data was capped at 12 g/t and is summarised in Table 14-60.

Table 14-60 Revised statistics of the downhole composites with grade capping applied

Domain	Uncapped Mean	Capping Au g/t	Capped Count	Capped Mean	%Mean Reduction
101	2.41	12	14	2.12	-12%

14.4.3.15 Density

Bulk density measurements are not available for the Wills Prospect. Values derived from production records at the Challenge Palaeochannel open pits were assigned to the model (Table 14-61).

Table 14-61 Density value used in the block model

Lithology	Density (t/m ³)
Soil/Alluvium	1.40
Laterite/Saprolite	1.60
Oxidised	1.80
Transition	2.30
Fresh	2.89

14.4.3.16 Variography

Variogram modelling was carried out on Domain 101, the most well informed domain. A normal score transformation was applied to the data to mitigate the effect of outliers. An omnidirectional variogram model in the plane of mineralisation was modelled with a high nugget at 70% (Figure 14-50). Details of the variogram parameters are presented in Table 14-62.

Figure 14-50 Downhole variogram (left) and variogram model for Domain 101 (right)

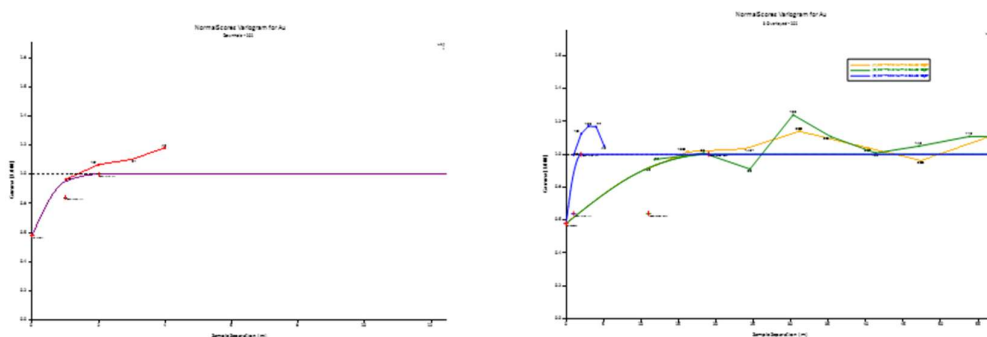

Table 14-62 Variogram parameters for Domain 101

Domain	Nugget	Spherical 1				Spherical 2				Surpac Rotation		
		sill	major (m)	semi (m)	minor (m)	sill	major (m)	semi (m)	minor (m)	Bearing	Plunge	Dip
101	0.71	0.09	11	11	1	0.2	19	19	2	70	0	0

KNA was carried out to determine the optimal search parameters for ordinary kriging estimation of gold grade. A multiple blocks approach was used rather than a single block analysis.

- The targeted parent block size used was 10 mX x 10 mY x 5 mZ to carry out the KNA.
- The parameters of the variogram model were referenced for the choice of search ellipse orientation and the drill hole spacing was used as the search distance.
- The slope of regression and kriging efficiency were used to decide on optimal minimum and maximum numbers of samples to use during estimation.

A minimum and maximum number of samples of 6 and 18 were selected for Domain 101.

14.4.3.17 Block Model and Grade Estimation

The extent of the block model defined for Wills is outlined in Table 14-63. The parent block size was selected to be 10 mX x 10 mY x 5 mZ, which reflects the average drill hole spacing of the area as the western part of the deposit is more closely drilled at 10 mX x 20 mY, while the eastern part is drilled at 30 mX x 20 mY. The parent block size was sub-blocked to 2.5 mX x 2.5 mY x 0.5 mZ, to best honour the interpreted domains.

Table 14-63 Wills block model definition

	X	Y	Z
Minimum Coordinate	6,514,200	370,600	200
Maximum Coordinate	6,515,200	372,000	500
Block Size	10	10	2
Minimum Sub-block Size	2.5	2.5	0.5
Rotation	0	0	0

An ordinary kriging interpolation was used to estimate the gold inside Domain 101. An ID² interpolation was used for Domain 1022, as no variogram could be modelled due to the limited number of composites within this domain.

The estimation was carried out in three stages where details of the first pass parameters are listed in Table 14-64. The second pass was double the first pass search distance. The third pass was three times the first pass search distance and the minimum number of composites used was relaxed to one. All blocks were filled within the three passes. A limitation of four composites per drill hole was also applied for Domain 101.

Table 14-64 Estimation parameters for Domains 101 and 1022

Domain	Surpac Rotation			Pass1					
	Bearing	Plunge	Dip	Min samples	Max Samples	Search major	Search Semi-major	Search minor	Sample per BHID
101	70	0	0	6	18	30	30	3	4
1022	44	0	0	6	18	30	30	3	

No global gold capping was applied to Domain 1022 as reflected in the low CV value; however, a local capping was applied for the high gold values to limit the spatial influence. Details of local capping for the estimated domains are listed in Table 14-65. The threshold value for the local capping was defined using the histogram of the domain of interest.

Table 14-65 Local Au capping parameters

Domain	Local capping Au g/t	Distance m
101	12	20
1022	4	20

Poorly informed domains were assigned the median value of the domain.

14.4.3.18 Model Validation

Validation processes for the gold estimate incorporated the following:

- Visual validation of the block estimate compared with the drill hole data on cross-section and elevation slices;
- Comparison of the average grade of the informing composites with the global estimate for each domain; and
- Computing trend plots in various directions, along strike, across strike and at elevation levels, to assess the quality of the local estimate.

The validation shows that the estimate honours the drill hole data. High grade areas in the estimate are supported by high grade intercepts in the drill hole data and the same is observed for low grade areas. A global statistical comparison between the de-clustered capped composite grade against the block estimate is within the acceptable range that corresponds to the assigned classification of the estimate.

14.4.3.19 Mineral Resource Classification

The Wills paleochannel deposit has been classified based on the confidence in the geological continuity, the quality of the grade estimate and the validation of the estimate. The western part of Domains 101 and 1022 have been classified as Indicated where the infill drilling is concentrated, and the mineralized wireframes are well defined. The average data spacing for the Indicated category is 20 m. The remainder of the domains were classified as Inferred, with an average data spacing between 30 m to 40 m. Minor domains defined by no more than two drill holes remain unclassified and represent mineral potential. The Wills block model coloured by resource classification is shown in Figure 14-51.

Figure 14-51 Plan view of Wills Deposit colour coded by resource classification: green=Indicated, red=Inferred, grey=unclassified

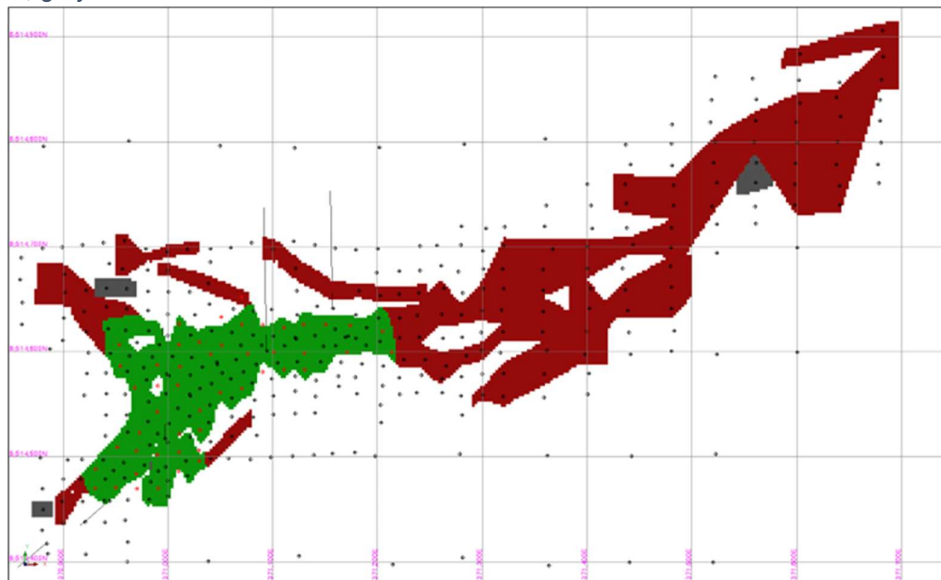

14.4.3.20 Mineral Resource Statement

The Mineral Resource Statement presented herein sets out the Gold Mineral Resource estimate prepared in accordance with the Canadian Securities Administrators' National Instrument 43-101 and Form 43-101F. The Mineral Resource estimate as set out in Table 14-66 is effective as of September 30, 2023. The Mineral Resource at the Wills gold deposit has been reported using a 0.5 g/t Au cut-off for open pit material within a US\$1,700 optimised pit shell.

Table 14-66 Wills Mineral Resource using 0.5 g/t Au cut-off

MRE Summary	Measured			Indicated			Measured & Indicated			Inferred		
	kt	g/t	koz	kt	g/t	koz	kt	g/t	koz	kt	g/t	koz
Wills	-	-	-	70	2.5	6	70	2.5	6	-	-	-

- 1) Mineral Resources that are not Mineral Reserves do not have demonstrated economic viability. There is no certainty that all or any part of the Mineral Resources estimated will be converted into Mineral Reserves.
- 2) The Measured and Indicated Mineral Resources are inclusive of those Mineral Resources modified to produce Mineral Reserves.
- 3) The Mineral Resource estimates include Inferred Mineral Resources that are normally considered too speculative geologically to have economic considerations applied to them that would enable them to be categorized as Mineral Reserves. There is also no certainty that Inferred Mineral Resources will be converted to Measured and Indicated categories through further drilling, or into Mineral Reserves once economic considerations are applied.
- 4) The Gold Mineral Resources are reported using a long-term gold price of US\$1,700/oz with a USD:AUD exchange rate of 0.70.
- 5) The Gold Mineral Resource was reported using a 0.5 g/t cut-off grade taking into account variable operational costs associated with the Higginsville Open Pits.
- 6) Classification is according to JORC Code and CIM Definition Standards Mineral Resource classification categories.
- 7) The Mineral Resource is depleted for mining to September 30, 2023.
- 8) To best represent 'reasonable prospects of eventual economic extraction', the Mineral Resource for open pits has been reported within an optimized pit shells at A\$2,429/oz (US\$1,700/oz).
- 9) Mineral Resource tonnage and contained metal have been rounded to reflect the accuracy of the estimate, and numbers may not add due to rounding.
- 10) Gold Mineral Resource estimates were prepared under the supervision of Qualified Person S. Devlin, FAusIMM (Chief Geological Officer, Karora Resources).

14.4.4 Musket

14.4.4.1 Summary

The Musket gold deposit is located within the Higginsville Regional Exploration Area defined by Karora which includes the Higginsville Gold Operations. The deposit is located approximately 82 km by road southeast of the Higginsville Mill, and accessed via station tracks and fence lines (Figure 14-52).

Musket has not previously been mined. BP Minerals commenced exploration in this area in 1987 and extensive work was carried out by a succession of companies. Avoca acquired the lease in late 2003 and continued exploration with soil sampling and drilling with diamond, RC and RAB methods. Metals X acquired the project in 2013 and demerged into Westgold in early December 2016.

The most recent Mineral Resource was completed in May 2017 by Westgold and re-optimised for RPEEE in 2020.

The Buldania combined reporting group is situated at the far southern extension of the Norseman-Wiluna greenstone belt, within the Archean Yilgarn Craton. The geology of this area comprises a complex tectonostratigraphic assemblage of mafic, ultramafic and sedimentary-dominated units metamorphosed under amphibolite to greenschist facies conditions.

Figure 14-52 Musket location map

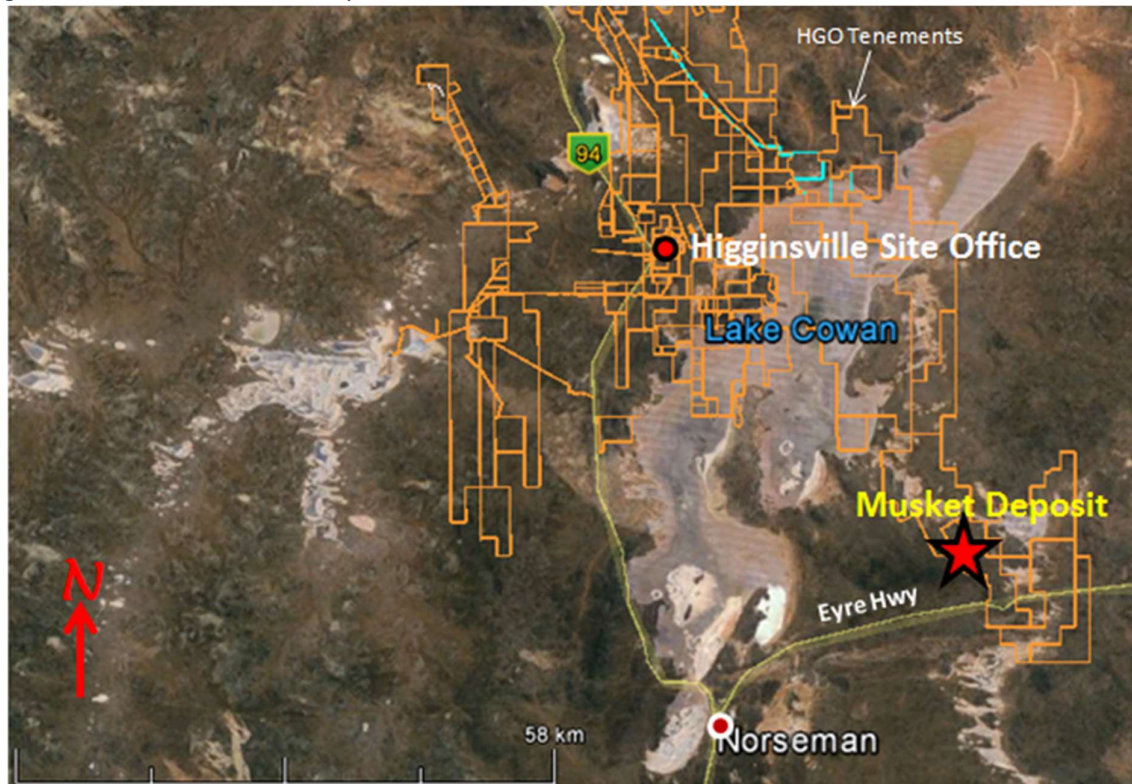

The Musket Deposit is controlled by a northwest striking structural corridor hosted by felsic volcanoclastic rocks. Mineralisation is within shear lodes exhibiting a shallow plunge 9° toward 305° . The structures are bifurcating and footwall splay lodes are common. Pyritic and silica alteration is commonly much stronger in areas of gold mineralisation (Figure 14-53 and Figure 14-54).

The lower mafic/ultramafic stratigraphy, seen to the west of the Musket prospect, is interpreted to correlate with the Woolyeenyer Formation and the Kalgoorlie Group. The middle to upper sequence of felsic volcanic and sedimentary rocks is interpreted to correlate with the Mount Kirk Formation and the Black Flag Beds. The Musket Prospect is situated within this sequence of rocks. The upper-most sequence, located east of the project area, is composed of mudstone, siltstone and greywacke. It is poorly exposed and exhibits very little magnetic contrast.

Historically, the gold anomalism was interpreted to be controlled by a northwest striking structural corridor hosted by felsic volcanoclastic rocks. According to Le Brun (2009), the mineralization is noted to be hosted within the silicified felsic volcanics, along a possible shear structure. No reliable direct correlations between the presence of gold mineralisation and alteration, structure or lithology were able to be identified.

Gold mineralisation is characterised by strong silicification and sulphidation of felsic volcanic and volcanoclastic rocks with almost no associated quartz veining.

Figure 14-53 Schematic diagram of the Musket deposit

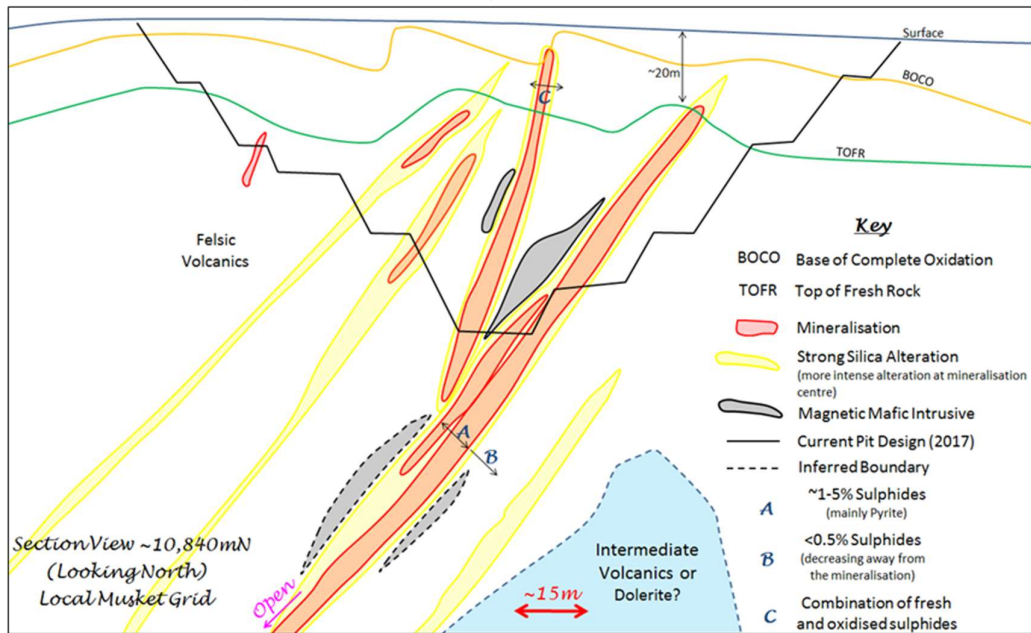
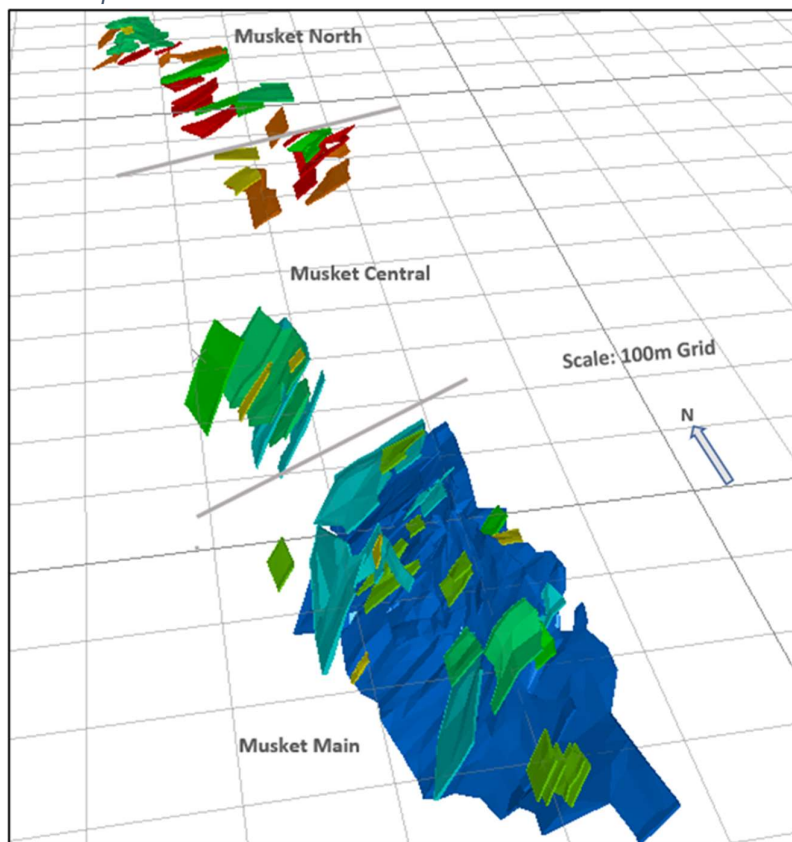

Figure 14-54 Musket interpreted lenses



14.4.4.2 Drilling and Sample Data

The Musket Mineral Resource estimate was completed by Westgold using predominantly reverse circulation and diamond drilling methods. The database used by Westgold was exported from Datashed on May 4, 2017. A subset of the export was extracted with the collar location restricted from 6,455,500 mN to 6,458,000 mN (MGA Grid), and from 409,500 mE to 412,100 mE (MGA Grid) for a total of 786 holes (Table 14-67). Although RAB and aircore drill holes comprise 46% of the total drill holes and 21% of the total metres in the export, these were only used to guide the mineralised wireframe interpretation and not used in the estimation.

Table 14-67 Musket data export – drill hole summary

Drill Hole Type	Actual		Percentage	
	Drill Holes	Metres	Drill Holes	Metres
RAB	335	7,199	33.0%	15.0%
Aircore	23	883	2.3%	1.8%
RC	620	35,209	61.1%	73.5%
Diamond	36	4,632	3.6%	9.7%
Total	1,014	47,923	100%	100%

14.4.4.3 Modelling Domains

The Musket mineralisation was interpreted in GEOVIA Surpac™ using a 0.5 g/t Au cut-off. The interpreted 10 m sectional outlines were manually triangulated to form wireframes using the downhole Au grades. The wireframes were validated in three dimensions to ensure consistency of lode shape and to accurately capture any cross-cutting relationships between the mineralised zones. A minimum downhole length of 2 m was used with no edge dilution. To allow for continuity, a maximum of 2 m of internal dilution was included in some intersections.

Wireframes representing an intrusive diorite were created using lithology logging codes. Westgold noted a correlation of increased silica alteration and sulphide percentage with gold grade and interpreted a silica alteration wireframe using alteration logging codes.

Westgold interpreted three distinct areas at Musket (Table 14-68).

Table 14-68 Musket area naming convention

Current Name	Previous Name
Musket	Musket Main/Silver Spear
Barrel	Musket Central
Bayonet	Musket North

The interpretation method varied depending on the style of mineralisation. The silica wireframes were used as a general guide for the steep (primary) mineralisation (1000 domain series) due to the noted correlation of grade and silicification. Following the completion of grade control drilling, the Barrel and Bayonet areas were re-interpreted as shallow dipping within intermediate volcanics, with a series of flat (supergene) lodes interpreted at the BOCO surface. These formed the 2200 and 9200 series domains. Previous supergene layers at Musket were merged into the 1100 and 9100 series due to an approximate shift of 20 m upwards of the interpreted BOCO surface. Very minor supergene mineralisation occurs at Musket with the majority occurring at Bayonet (Domain 2209). A series of moderately west dipping (approximately 40°–50°) lodes

were interpreted as feeder pipes at Barrel and Bayonet and designated as 3300 and 9300 series.

The interpreted mineralisation at the deposit is shown in Figure 14-55. The silica alteration wireframes are shown in Figure 14-56.

Due to the lack of geological codes in the database, particularly the historical drill holes, and multiple generations of data, the oxidation surfaces were based on several constraints. The BOCO and TOFR surfaces were primarily based on the *Lith1_Oxidation* field (Weathering Code) in the *Lithology* table. Where the *Lith1_Oxidation* code was not present, the surfaces were based on the *Regolith* field (Regolith Group Code) in the *Regolith* Table.

Figure 14-55 Location plan of mineralised interpretation at the Musket deposit

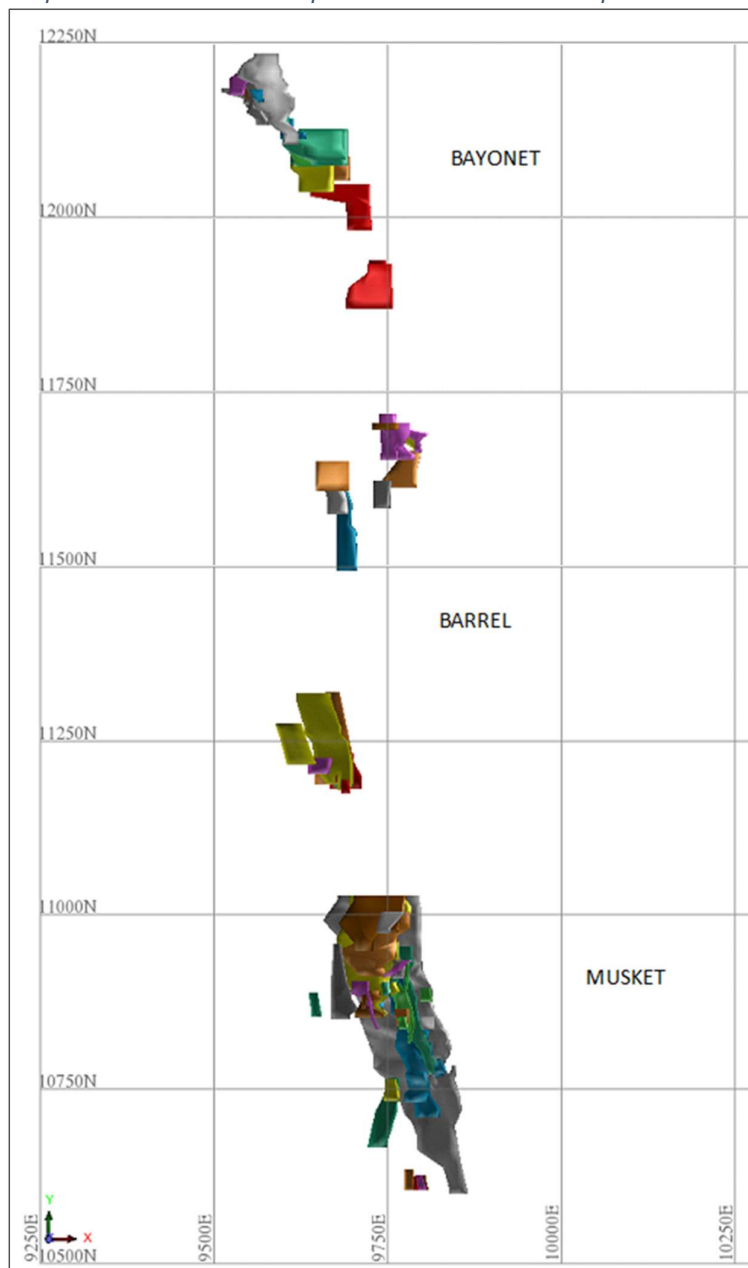
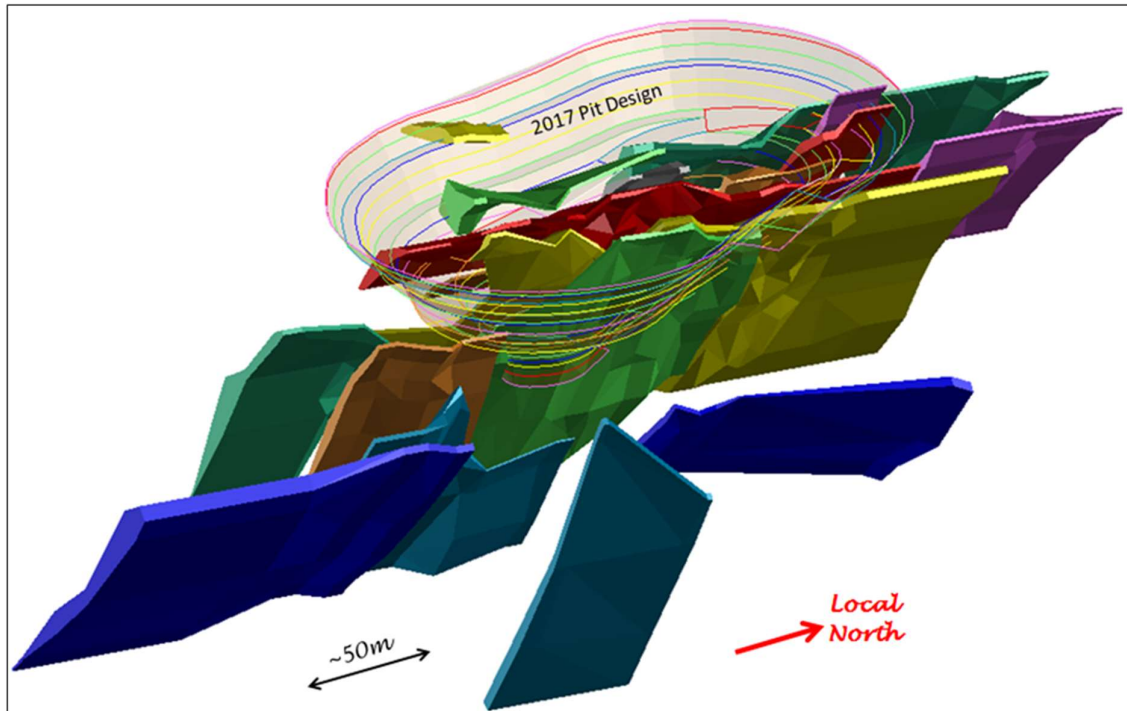

Figure 14-56 Isometric view of silica wireframe interpretation



14.4.4.4 Statistical Analysis and Compositing

An analysis of the raw sample length statistics was undertaken to determine an appropriate composite interval length. The analysis was undertaken on all samples contained within mineralised wireframes. The modal sample length was 1 m, with 82% of the samples taken at 1 m intervals. A composite length of 1 m was therefore utilised for the Musket resource.

The wireframes of the mineralised lodes were used to code the drill hole intersection into the database to allow identification of the resource intersections. GEOVIA Surpac™ was then used to extract downhole composites within the different domains. Holes were composited to 1 m with a minimum of 0.5 m. Individual composite files were created for each of the domains in the wireframe models and assigned a unique numerical code as discussed in the previous section.

A statistical summary was completed to assess domains for outlier values that would require grade capping. For analysis, some domains were grouped by geostatistical and geological similarities and the same top-cut applied to all domains in the group. Where enough data were available, and areas were geostatistically unique, domains were assessed separately. Top-cuts were determined by assessing normal and log-histograms for extreme values and using a combination of mean variance plots and population disintegration techniques.

Analysis of each domain showed that 15 lodes required capping and these values ranged from 10 g/t to 20 g/t. A summary of Au statistics for individual lodes is shown in Table 14-69.

Table 14-69 Summary statistics for all Musket domains

Domain	Count	Top-Cut (g/t)	No. Values Cut	Percentage Data Cut	Uncut Statistics		Cut Statistics	
					Mean	COV	Mean	COV
1101	566	20	7	1.24%	2.236	1.736	2.125	1.445
1102	177	20	1	0.56%	2.258	2.097	2.069	1.445
1103	202	20	3	1.49%	3.39	1.727	3.112	1.349
1104	69	-	-	-	2.257	1.202	1.033	1.202
1105	102	10	2	1.96%	1.013	1.739	0.976	1.573
1106	53	-	-	-	1.125	1.017	1.125	1.017
1108	26	10	2	7.69%	1.741	1.801	1.606	1.677
1109	44	10	1	2.27%	1.602	1.7	1.499	1.516
1110	29	-	-	-	0.841	0.645	0.841	0.645
1112	16	-	-	-	0.812	0.699	0.812	0.699
1113	12	-	-	-	1.058	0.745	1.058	0.745
1116	28	-	-	-	0.843	0.634	0.843	0.634
1117	10	-	-	-	1.326	1.037	1.326	1.037
1118	10	-	-	-	0.777	0.394	0.777	0.394
1119	17	-	-	-	0.807	1.104	0.807	1.104
1125	6	-	-	-	0.587	0.39	0.587	0.39
1134	16	10	1	6.25%	3.46	2.377	1.96	1.241
1135	26	-	-	-	1.055	0.833	1.055	0.833
2201	6	-	-	-	3.112	1.297	3.112	1.297
2207	10	-	-	-	1.262	0.796	1.262	0.796
2209	137	16	1	0.73%	1.806	1.382	1.763	1.232
3309	42	15	2	4.76%	3.188	2.207	2.593	1.591
3310	27	-	-	-	1.975	0.733	1.975	0.733
3317	6	10	1	16.67%	5.123	1.982	2.494	1.514
3318	36	-	-	-	1.578	1.373	1.578	1.373
9111	6	-	-	-	1.99	0.943	1.99	0.943
9114	10	-	-	-	0.872	0.882	0.872	0.882
9115	11	-	-	-	0.836	0.552	0.836	0.552
9120	21	-	-	-	0.803	1.275	0.803	1.275
9122	23	-	-	-	1.194	0.841	1.194	0.841
9123	4	-	-	-	0.575	0.113	0.575	0.113
9124	6	-	-	-	0.571	0.644	0.571	0.644
9126	9	-	-	-	0.817	0.919	0.817	0.919
9127	4	-	-	-	0.678	0.346	0.678	0.346
9128	7	-	-	-	0.818	1.048	0.818	1.048
9130	8	-	-	-	0.788	0.694	0.788	0.694
9131	8	-	-	-	0.848	0.664	0.848	0.664
9133	4	-	-	-	3.695	1.575	3.695	1.575
9136	16	-	-	-	0.733	0.63	0.733	0.63
9137	4	-	-	-	0.571	0.339	0.571	0.339
9138	4	-	-	-	0.995	1.074	0.995	1.074
9139	10	-	-	-	1.151	0.746	1.151	0.746

Domain	Count	Top-Cut (g/t)	No. Values Cut	Percentage Data Cut	Uncut Statistics		Cut Statistics	
					Mean	COV	Mean	COV
9140	6	10	1	16.67%	4.008	1.751	2.675	1.48
9202	8	-	-	-	0.953	0.458	0.953	0.458
9203	15	-	-	-	2.387	1.247	2.387	1.247
9206	10	-	-	-	0.956	0.604	0.956	0.604
9215	4	16	2	50.00%	8.872	0.995	8.622	0.99
9301	11	-	-	-	0.47	0.754	0.47	0.754
9302	20	15	0	0.00%	0.842	0.65	0.842	0.65
9303	18	-	-	-	1.597	0.748	1.597	0.748
9304	38	15	2	5.26%	3.187	1.583	3.078	1.516
9305	11	-	-	-	2.285	0.985	2.285	0.985
9306	7	-	-	-	2.286	1.092	2.286	1.092
9307	4	-	-	-	1.18	1.122	1.18	1.122
9308	16	-	-	-	1.484	1.108	1.484	1.108
9311	8	-	-	-	1.891	1.064	1.891	1.064
9312	4	-	-	-	2.45	0.777	2.45	0.777
9313	40	15	2	5.00%	2.432	1.675	2.373	1.608
9314	16	-	-	-	1.582	0.975	1.582	0.975
9315	12	-	-	-	1.937	0.928	1.937	0.928
9316	7	-	-	-	2.478	0.823	2.478	0.823
9319	8	-	-	-	2.256	1.626	2.256	1.626
9320	8	-	-	-	1.042	0.963	1.042	0.963
9321	16	-	-	-	2.18	1.198	2.18	1.198
9322	6	-	-	-	1.571	0.455	1.571	0.455
9323	20	-	-	-	2.965	1.273	2.965	1.273

14.4.4.5 Density

Density values were assumed at Musket and assigned to various material and rock type as summarised in Table 14-70. Westgold assigned the values to diorite units based on the Line-of-Lode models (Trident, Fairplay and Two Boys) as those deposits were considered to have similar geology. For the felsic volcanics, the bulk density values were adopted from an earlier model; however, the source of those values was unknown to Westgold.

Table 14-70 Density assigned to the Musket block model

Material	Diorite (t/m ³)	Felsic Volcanics (t/m ³)
Oxide	1.8	1.8
Transitional	2.4	2.3
Fresh	2.65	2.68

In October/November 2017, Westgold completed a bulk density sampling program of available diamond core using the water displacement (Archimedes) method. A total of 24 measurements were completed through mineralized wireframes and 647 outside mineralized domains. All samples were in fresh material. The resultant average density for both datasets was

approximately 2.7 t/m³. Westgold recommended that this value be applied to future models at the deposit.

14.4.4.6 Variography

Traditional variograms were analysed for grade continuity directions using Supervisor 8.5 software. Before calculating the variogram, a normal scores transformation was performed on the data, converting the skewed grade distribution to a standard normal distribution. The effect is to limit the influence of extreme grades, which are common in precious metal deposits of this type. For use in the estimation, the normal score variogram models were back transformed.

Where applicable, domains of similar orientation, geology and statistics were grouped to provide more data for analysis, especially where each individual domain had too few composites to allow for robust variograms to be modelled.

Variograms were modelled for the steep (1000 series) and all the data from the flat (2000 series) lodes. The geological context of each area was used to guide the modelling. Variogram models for Domain 1101 are shown in Figure 14-57.

Figure 14-57 Normal scores variogram for Domain 1101

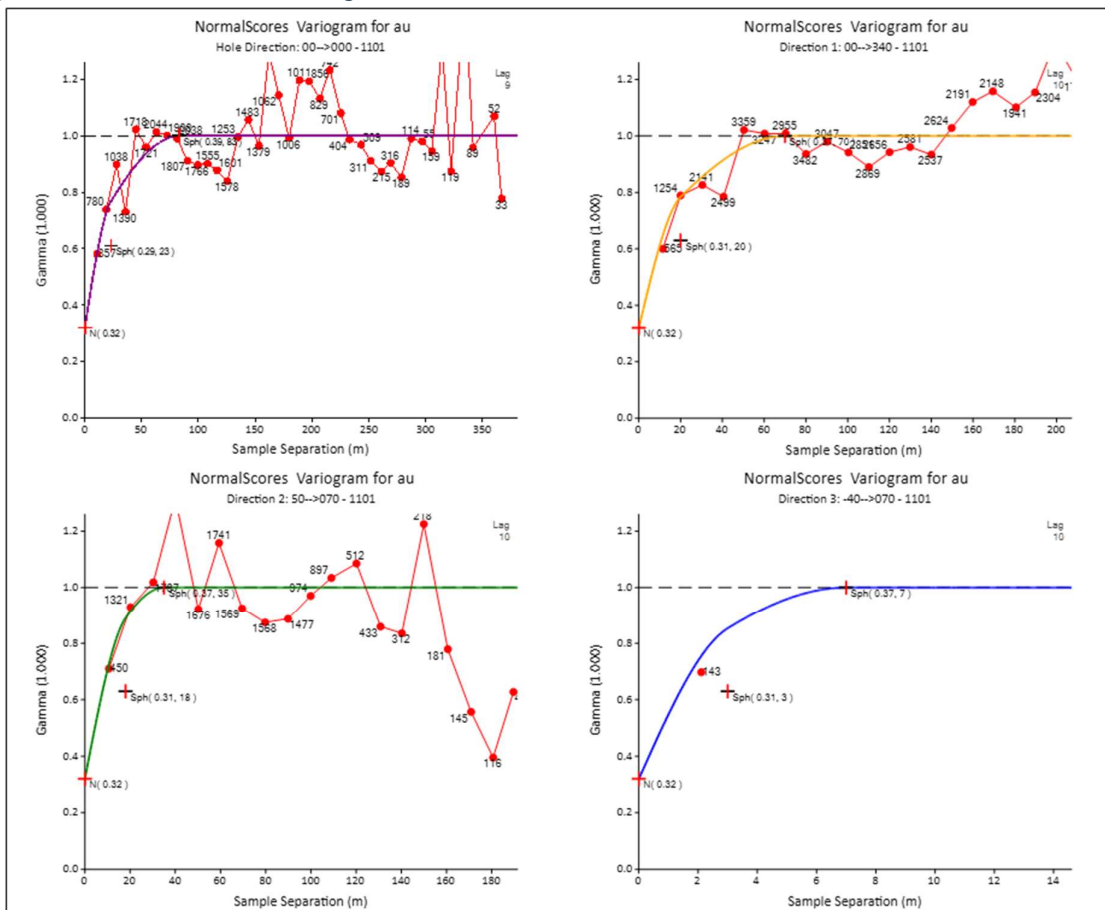

A summary of the grouping employed and variogram model parameters for each area is given in Table 14-71.

Table 14-71 Variogram parameter summary

Domain	Direction	Nugget	Structure 1		Structure 2		Structure 3		Bearing Plunge Dip	Major	Minor
			Sill	Range	Sill	Range	Sill	Range			
1101	00 → 340	0.44	0.3	20	0.2	70	-	-	340	1.11	6.67
	50 → 070			18		35		-	0	2	10
	-40 → 070			3		7		-	50	-	-
2209	00 → 340	0.46	0.3	14	0.3	30	-	-	290	1.08	7
	00 → 290			13		25		-	0	1.2	5
	90 → 000			2		6		-	0	-	-
3300	00 → 350	0.24	0.6	55	0.2	95	-	-	350	1.83	9.17
	20 → 260			30		55		-	0	1.73	10.56
	70 → 080			6		9		-	-20	-	-
Waste	06 → 008	0.19	0.6	12	0.1	70	0.1	500	7.69	1.2	1.2
	39 → 103			10		100		200	6.41	0.7	1.17
	-50 → 090			10		60		160	39.57	2.5	3.13

14.4.4.7 Block Model and Grade Estimation

The Westgold block model was created using GEOVIA Surpac™ to encompass the full extent of the deposit. The block modelling and estimation were carried out in a local grid. Block cell sizes were determined based on a kriging neighbourhood analysis. The parent block size was set to 5 mY x 5 mX x 2.5 m vertical with sub-blocking to a minimum 1.25 m x 1.25 m x 1.25 m. A block model summary is shown in Table 14-72.

Table 14-72 Musket block model summary

Axis	Minimum	Maximum	Extent	Parent size	Number of rows	Minimum subcell
Y	9,690	12,350	2,660	5	532	1.25
X	9,350	10,150	800	5	160	1.25
Z	100	350	250	2.5	100	1.25

Ordinary kriging (OK) was used for the gold grade interpolation. The search ranges were based on the variogram continuity. The first pass used a search radii equivalent to that of the variogram range with the number of samples and discretisation based on the KNA results. A second search pass was run for the un-estimated cells by halving the minimum number of samples and the search radii equivalent to the variogram range. A third pass was estimated using half the minimum number of samples and doubling the search radii. A fourth search pass was used which doubled the search radii and reduced the minimum number of samples to two.

14.4.4.8 Model Validation

Final grade estimates were validated by statistical analysis and visual comparison to the input drill hole data. The block volume of each domain was also compared to the corresponding wireframe volume to ensure the sub size chosen allowed for accurate representation of the mineralisation volumes.

The overall mean of the block model was within -0.5% of the de-clustered mean and 12% of the raw mean. The model was deemed to be fair and representative of the grade within the domains.

The block model volume was within 7% of the wireframe volume and Westgold concluded that the model was a fair reflection of the mineralised volumes (Figure 14-58).

Figure 14-58 Model volume comparison for Musket

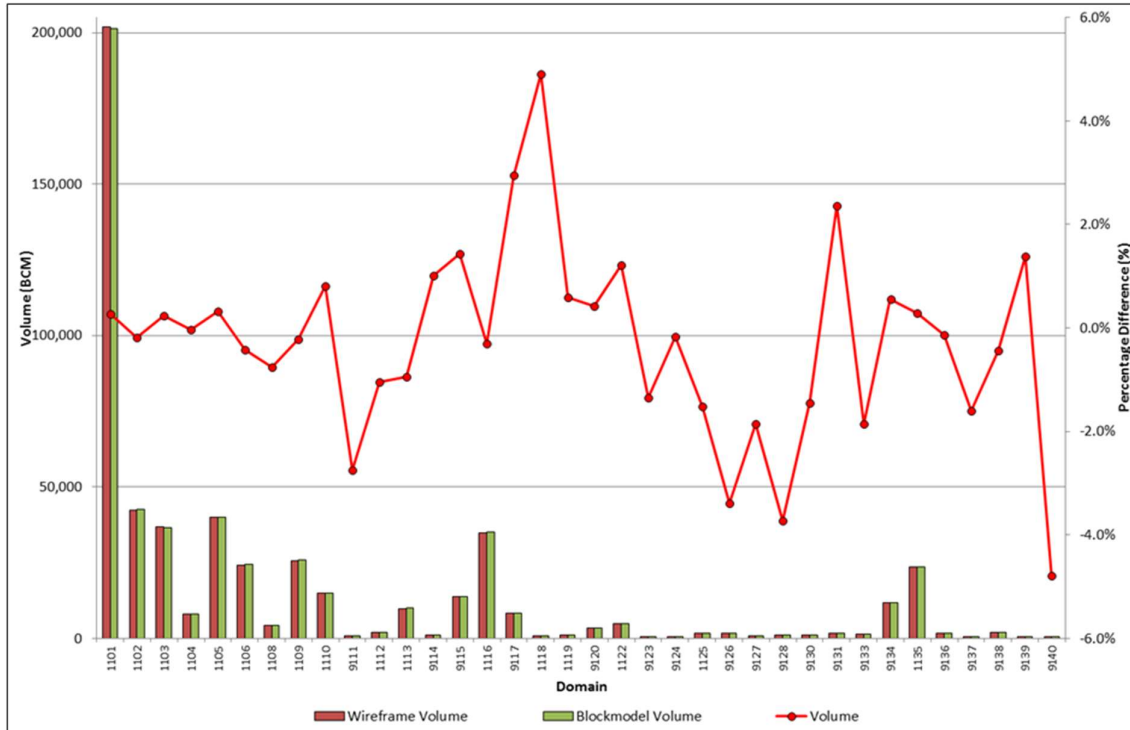

Sectional and elevation validation profiles were generated for each lode. The profiles compare the volume-weighted average of the block grades to the length-weighted mean of the input composite grades for northing, easting and elevation slices through the block model. Trend plots assist in the assessment of the reproduction of local mean grades and are used to validate grade trends in the model.

The model provides a good local reproduction of the composite input grades, with model grades tending to be 'smoother' or less variable than the mean composite grades, but not overly so. This is both the result of the modelling process and the volume variance effect, where the blocks represent a larger volume than the composites and as such there is less variation expected in the block grades.

The trend plot for Domain 1101 is shown in Figure 14-59.

Westgold concluded that the validation indicated that the Mineral Resource model replicates the source input data well.

Figure 14-59 Trend plots for Domain 1101

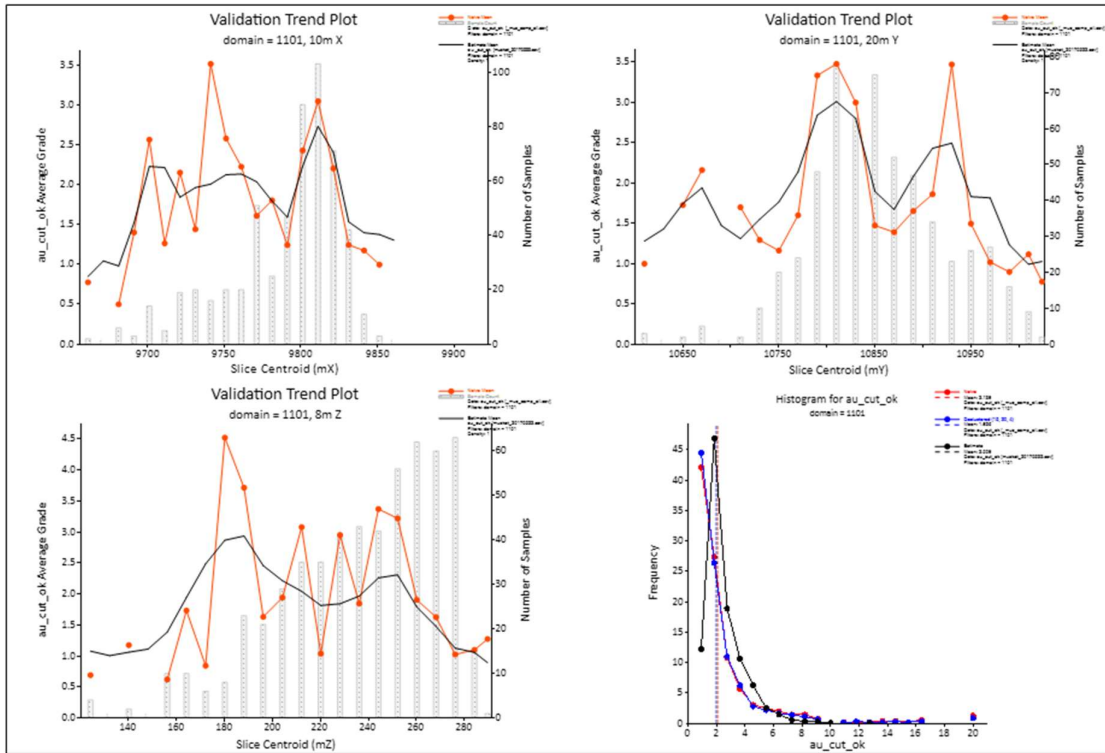

14.4.4.9 Mineral Resource Classification

The Musket Mineral Resource was classified in accordance with the JORC Code 2012 guidelines. A reconciliation of this reporting and the CIM Definition Standards (2014) by the Qualified Person shows no material differences.

The deposit has been classified as Measured, Indicated or Inferred Mineral Resource. Westgold did not specify how the Measured category was applied to the model.

The Indicated portion of the Mineral Resource was defined across areas drilled to 20 m x 20 m spacing.

The remainder of the lodes were classified as Inferred Mineral Resource to a maximum extrapolated distance of 40 m.

14.4.4.10 Mineral Resource Statement

The Mineral Resource Statement presented herein sets out the Gold Mineral Resource estimate prepared in accordance with the Canadian Securities Administrators’ National Instrument 43-101 and Form 43-101F. The Mineral Resource estimate as set out in Table 14-73 is effective as of September 30, 2023. The Mineral Resource at the Musket gold deposit has been reported using a 0.5 g/t Au cut-off.

Table 14-73 Musket Mineral Resource using 0.5 g/t Au cut-off

MRE Summary	Measured			Indicated			Measured & Indicated			Inferred		
	kt	g/t	koz	kt	g/t	koz	kt	g/t	koz	kt	g/t	koz
Musket	99	2.3	7	392	2.2	28	491	2.2	35	290	1.7	16

- 1) Mineral Resources that are not Mineral Reserves do not have demonstrated economic viability. There is no certainty that all or any part of the Mineral Resources estimated will be converted into Mineral Reserves.
- 2) The Measured and Indicated Mineral Resources are inclusive of those Mineral Resources modified to produce Mineral Reserves.
- 3) The Mineral Resource estimates include Inferred Mineral Resources that are normally considered too speculative geologically to have economic considerations applied to them that would enable them to be categorized as Mineral Reserves. There is also no certainty that Inferred Mineral Resources will be converted to Measured and Indicated categories through further drilling, or into Mineral Reserves once economic considerations are applied.
- 4) The Gold Mineral Resources are estimated using a long-term gold price of US\$1,700/oz with a USD:AUD exchange rate of 0.70.
- 5) The Gold Mineral Resource was reported using a 0.5 g/t cut-off grade accounting for variable operational costs associated with the Higginsville Open Pits.
- 6) Classification is according to JORC Code and CIM Definition Standards Mineral Resource classification categories.
- 7) The Mineral Resource is depleted for mining to September 30, 2023.
- 8) To best represent 'reasonable prospects of eventual economic extraction', the Mineral Resource for open pits has been reported within an optimized pit shells at A\$2,429/oz (US\$1,700/oz).
- 9) Mineral Resource tonnage and contained metal have been rounded to reflect the accuracy of the estimate, and numbers may not add due to rounding.
- 10) Gold Mineral Resource estimates were prepared under the supervision of Qualified Person S. Devlin, FAusIMM (Chief Geological Officer, Karora Resources).

14.4.5 Lake Cowan Deposits

14.4.5.1 Summary

The Lake Cowan Project area is located approximately 20 km ENE of the Higginsville Mill and can be accessed via private haul road. Station tracks and fence lines provide access to most of the project away from the Higginsville infrastructure. The Lake Cowan area consists of five gold deposits: Atreides, Josephine, Louis, Napoleon and Rose (Figure 14-60).

Figure 14-60 Lake Cowan Project area location plan

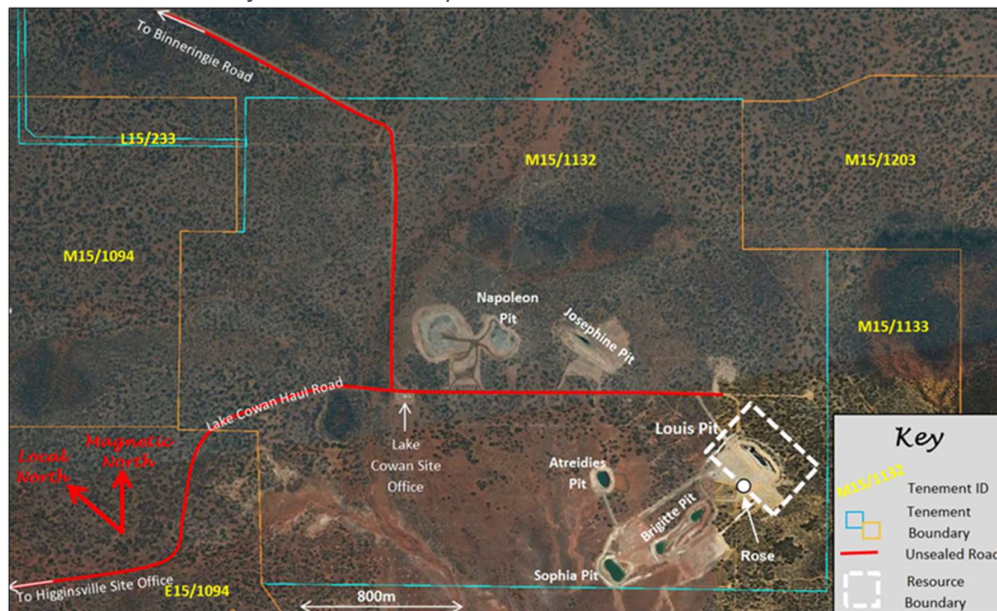

The existing models at each deposit were completed by previous owners. The Rose Deposit was completed by Metals X in 2014, and the remaining deposits completed by Westgold in 2018.

Significant drilling was completed in many areas at Lake Cowan, but with constraints imposed by long haulage distances and rising milling costs, only relatively few deposits were mined. Due to lower recoveries in the fresh sulphides, only the oxide portions of the structurally controlled deposits were extracted and only relatively small portions of the supergene systems.

Harmony South Kalgoorlie Mines commenced production from a series of four small oxide and palaeochannel pits (Louis, Josephine, Sophia-Brigitte and Atreides) at the start of January 2003, ceasing production in mid-July 2003 but continuing to move stockpiled ore to the Jubilee and New Celebration mills for several months after the cessation of mining.

Total high grade produced was 357,050 t @ 2.59 g/t for a total of 29,708 oz. Recovery through the mills was not as low as the earlier metallurgical testwork had suggested, being approximately 91% with some variation in the un-oxidised material recovered, giving a recovered metal figure of just above 27,000 oz.

A 110 t excavator and 85 t dump trucks were using for mining. Conventional 2.5 m benches were utilised in the structurally controlled pits where the mineralisation was semi-vertical. In the supergene pits, contour mining was used to extract the flat lying but undulating lodes to reduce dilution.

The Lake Cowan group of deposits are situated near the centre of a regional scale anticline between the Zuleika and Lefroy faults, with the intrusion of massive and complex Proterozoic Binneringie dyke. The anticlinal system comprises a complex succession of mafic, ultramafics, carbonaceous shales, felsic volcanics and volcanoclastic sediments which have been intruded by several younger felsic granitoids.

The host sequence of rocks at Louis, Josephine and Napoleon is generally highly altered, often vesicular mafic and ultramafic extrusives. The logging at Louis and Josephine suggests that mafics are dominant, but exposure in the pits suggests ultramafics are more volumetrically significant. At Josephine, there is also a weakly porphyritic, quartz-rich felsic intrusive which is heavily altered and contains significant mineralisation. At Louis, higher grades were generally thought to be associated with increased intensity of silica alteration.

Host rocks for the supergene deposits are sediments, which are related to the weathered contact between (once) sulphidic, carbonate altered carbonaceous shales and a coarse poorly sorted angular fragmental unit (volcanic/volcanoclastic). This unit contains a significant mafic and or ultramafic content, and early logging described it as basalt. However, in coarse drill chips and in exposed pit walls it is an angular fragmental unit.

14.4.5.2 Drilling and Sample Data

Drilling at Lake Cowan has been carried out by different contract companies between 1987 to 2018. During this period, samples were assayed using different laboratories and methods. The Avoca digital database contains collar, survey, assay and geological logging data for multiple drill types and across multiple projects. Data extracts were limited to the extent of each deposit with modelling carried out on local grids.

Summary tables reviewed at each deposit show that drilling is predominantly RC, RAB and AC. A total of 16 diamond holes have been completed at Josephine, Louis and Napoleon. All hole

types were used in the interpretation of mineralisation, but only RC and diamond holes were used in the model estimation.

Surface drill hole collars were picked up utilising differential GPS to an accuracy of +/-10 cm. Eastman Camera readings were recorded on all holes at 30 m intervals. Eastman Camera shots on holes that did not have a gyro survey were corrected by 4° to reflect a consistent bias noted between the gyro and camera, with spurious camera readings (due to pyrrhotite) removed.

The contract mine surveyors used Lake Cowan Mine grid coordinates, whereas the single shot downhole cameras recorded magnetic north readings. The difference between magnetic north and grid north at Lake Cowan is 35.0729° degrees. After March 1, 2014, all downhole survey readings were recorded as magnetic grid and translated to mine grid using the above correction.

14.4.5.3 Modelling Domains

The deposits at Lake Cowan can be separated into the following two types:

- Structurally controlled primary mineralisation in ultramafics, basalts and felsics (e.g. Louis, Josephine, Napoleon and Rose); and
- Saprolite/palaeochannel hosted supergene hydromorphic deposits, including Atreides.

Atreides is a typical Eastern Goldfields supergene deposit which is overlain by a palaeochannel. All the mineralised envelopes were modelled using a 0.5 g/t Au cut-off with a minimum downhole length of 2 m and a maximum of 2 m internal dilution. The interpretation methodology varied depending on the mineralisation style. Around the Atreides Pit, the mineralised envelopes were digitised with little or no dip. West of the Atreides Pit, the mineralised zones were digitised dipping toward the west (local) at an average of 24°. In both cases, the quartz percentage was used to guide the mineralised wireframes, and the interpretations followed the contours of the BOCO surface (Figure 14-61).

Figure 14-61 Flat lying mineralised shapes around the Atreides Pit area. Local section 10,420 mN ±5 m looking north

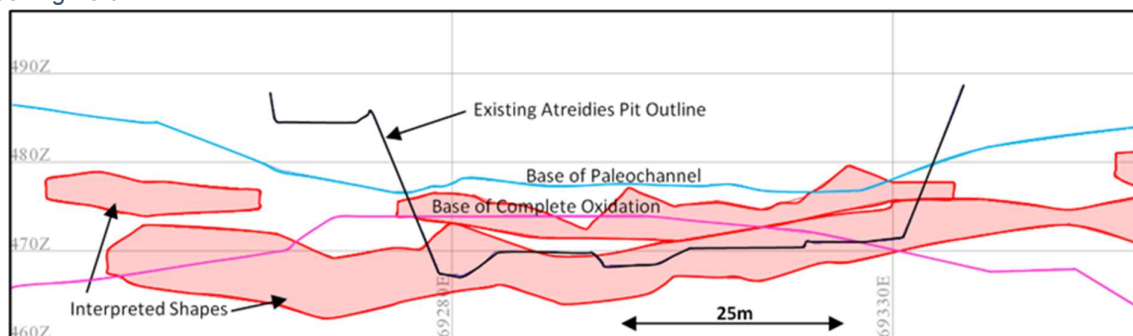

Josephine is a set of steeply dipping veins with less apparent supergene influence (Figure 14-62).

Figure 14-62 Josephine cross-section 11,130 mN – drilling Au grades vs mineralisation interpretation

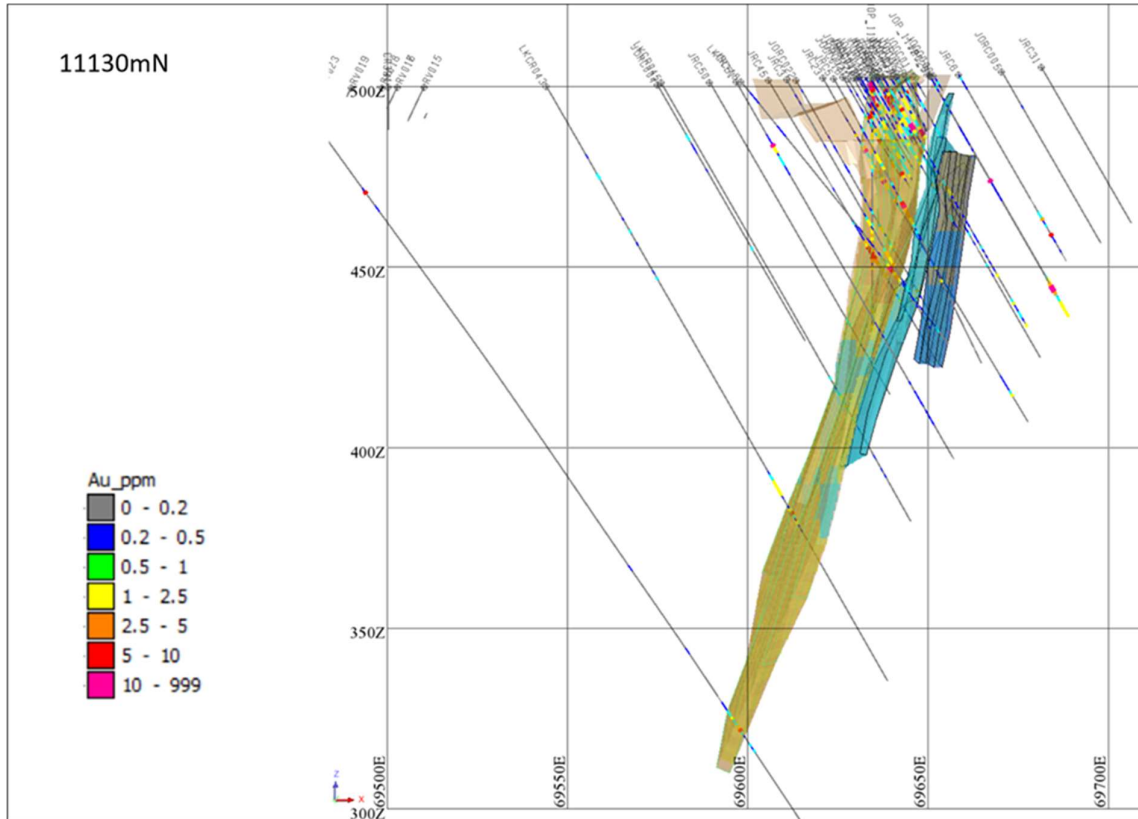

Louis and Rose are also sets of steeply dipping veins with some supergene development (Figure 14-63 and Figure 14-64).

Figure 14-63 Louis cross-section 9,980 mN – drilling Au grades vs mineralisation interpretation

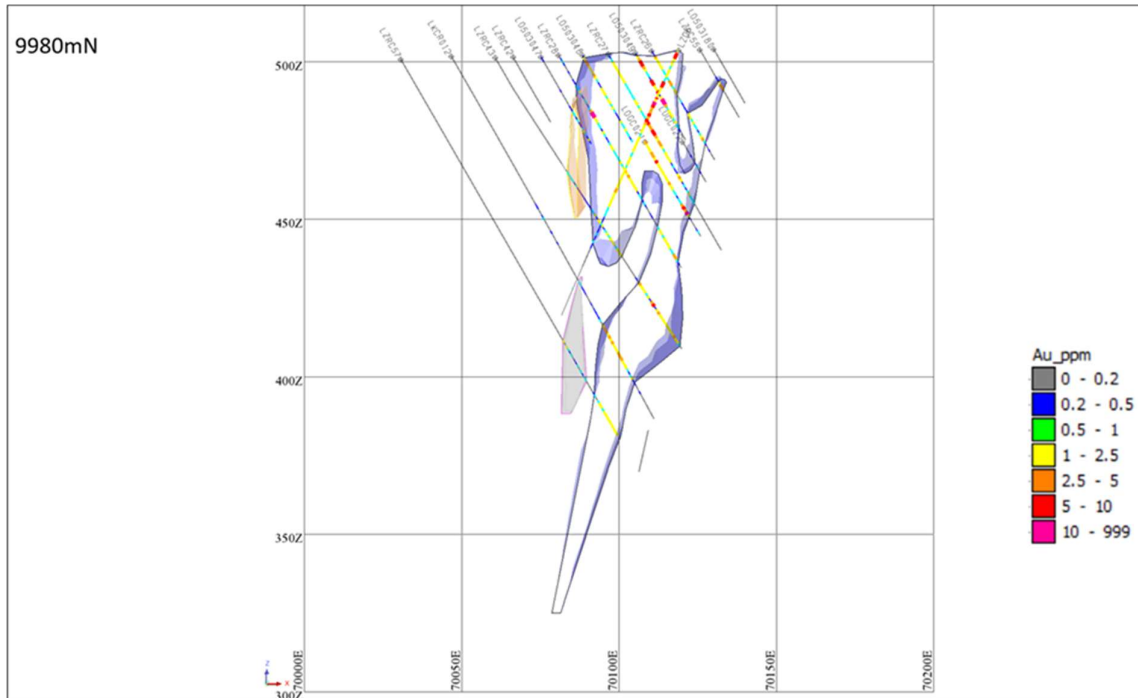
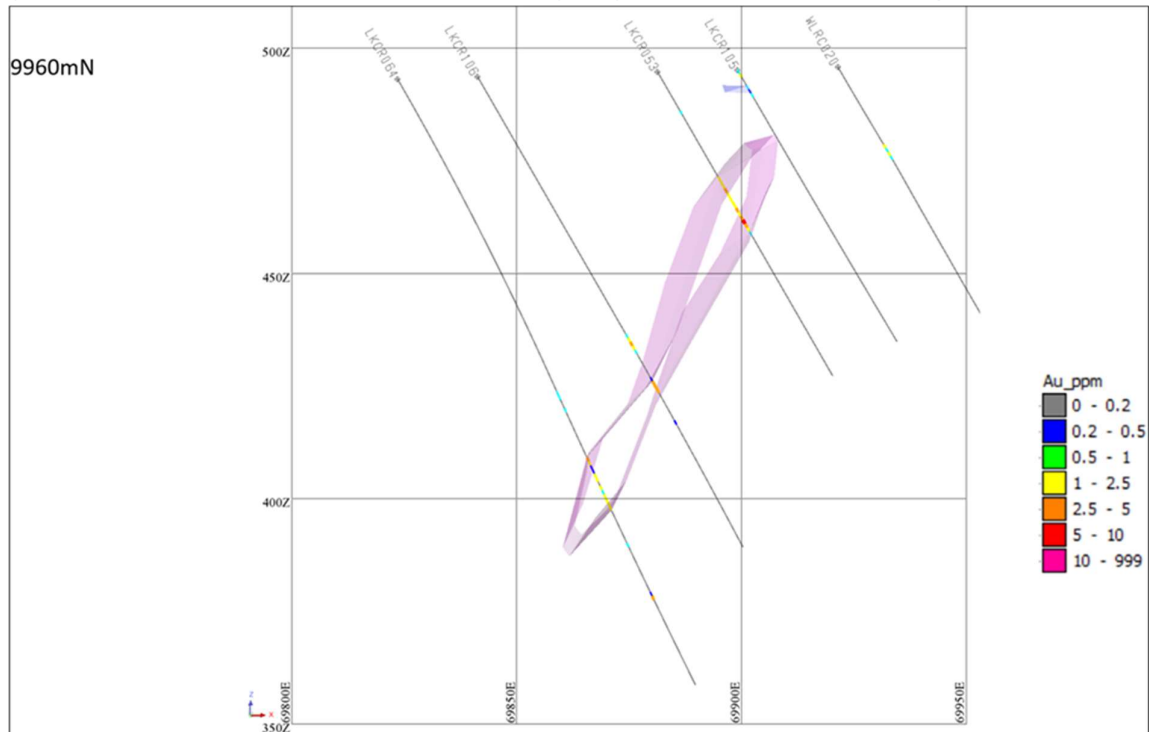

Figure 14-64 Rose cross-section 9,960 mN – drilling Au grades vs mineralisation interpretation



Napoleon is a structurally controlled primary deposit in ultramafics, basalts and felsics consisting of two dominant lode orientations: a steep sub-vertical (200 series) trend and a shallow to moderate west dipping (100 series) trend. The 100 series lodes dip at approximately 45° to 55° and strike north-south (local grid). These orientations were observed in the north wall of the Napoleon open pit. The Napolean interpretation is shown in Figure 14-65 and a typical cross-section is shown in Figure 14-66.

Figure 14-65 Napoleon Pit dipping and vertical lodes with the December 2015 end of month survey

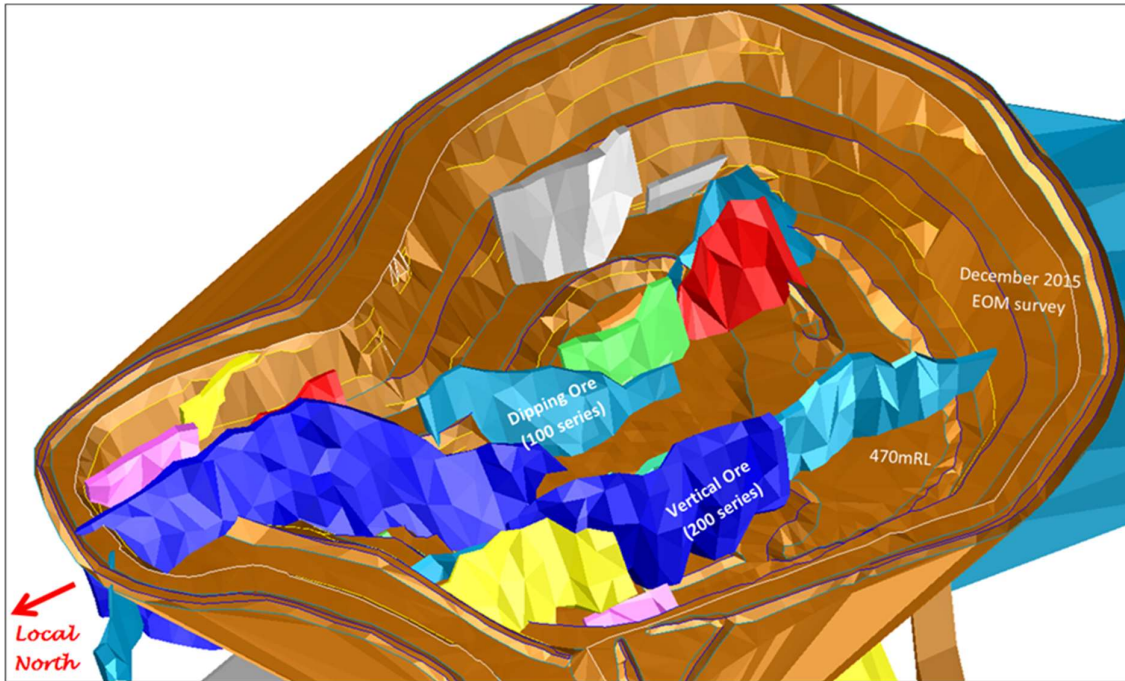
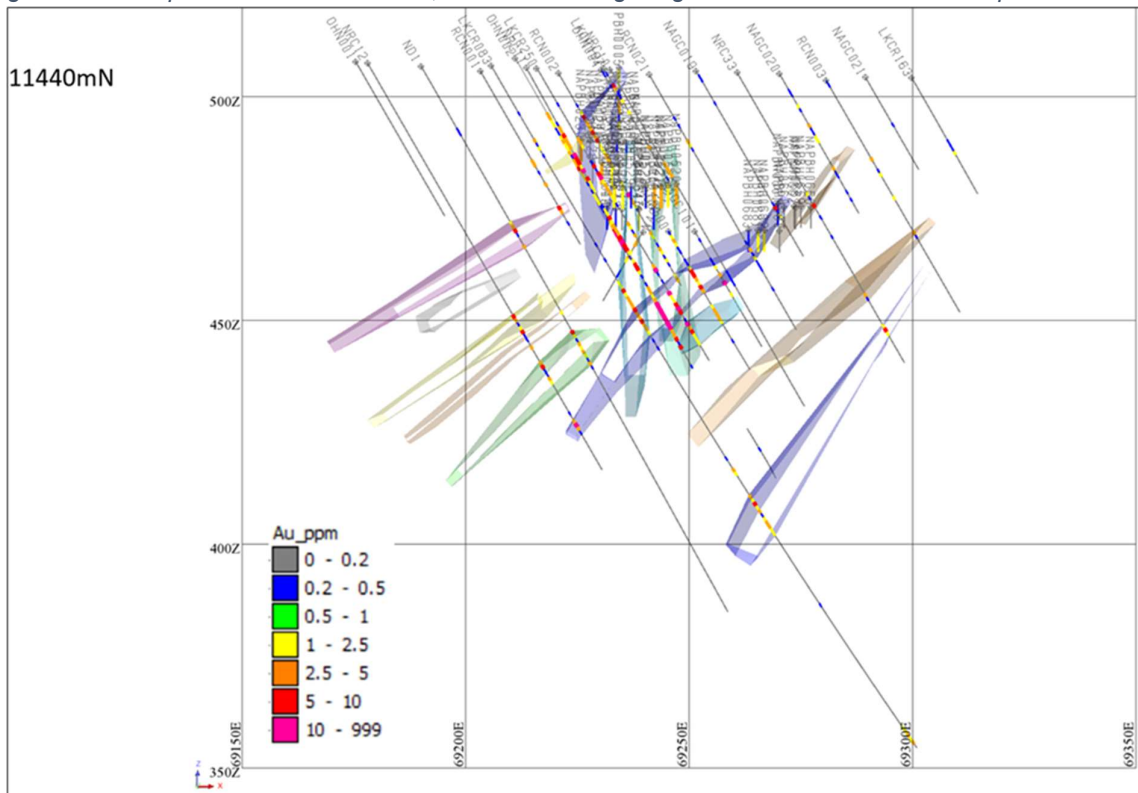

Figure 14-66 Napoleon cross-section 11,440 mN – drilling Au grades vs mineralisation interpretation



Where possible, the known geological controls on mineralisation within each of the Lake Cowan deposits (Atreides, Josephine, Napoleon and Rose) were used to guide mineralisation strings. Atreides, Josephine and Sophia-Brigette were mined in 2003 and grade control wireframes were used as the basis for the re-interpretation albeit expanded (where appropriate) to incorporate material between 0.5 g/t to 1.0 g/t Au which was not modelled previously. Geological information from drill holes drilled post-mining were used to extend the wireframe interpretation whilst remaining faithful to the known controls on mineralisation for each deposit. As such, the wireframes were not constrained by a hard geological boundary.

Mineralisation strings were digitised on section at either 5 m or 10 m spaced intervals to establish a 0.5 g/t Au cut-off envelope around the interpreted mineralisation. A maximum of 2 m of downhole internal dilution was included, and in cases where geological knowledge of the deposit allowed, the interpretation strings were continued through zones of lower grade to assist in modelling lode continuity, and to increase the level of along strike control on the location of the mineralised structure. An assumed minimum mineralisation width of 1 m was defined.

Strings were snapped to drill holes at sample interval boundaries, with no artificial complexities introduced into the lode geometry (although points were created between drill holes to ensure accuracy during wireframing). A string smoothing function was used which retained the original points, but added additional points between drill holes.

Wireframing of mineralisation sectional perimeters was performed via the linking of appropriate perimeters on adjacent sections. The wireframes were sealed by triangulation within the end member perimeters, leading to the creation of a volume model.

Oxidation surfaces were created by the digitising of strings on sections corresponding to the geologically logged oxidation states downhole. These digitised strings were expanded as appropriate to extend beyond the borders of the block models, with a DTM created by triangulating between adjacent strings.

The oxidation surfaces were considered representative of the sub-surface conditions proximal to the current open pits (Atreides and Josephine) as consistent logging was noted within the grade control logging. As drill density decreases distal to the pit, logging appears to be more erratic and thus the oxidation surfaces as created represent the current best guess sub-surface oxidation states. Oxidation surfaces at the Napoleon and Rose deposits similarly reflect the current best guess sub-surface oxidation states with more confidence in areas of higher drill density.

14.4.5.4 Statistical Analysis and Compositing

The interpreted mineralisation wireframes were used to create an intersection table within the database by marking for extraction all intervals of drill holes enclosed by the volume model. Each intersection was flagged according to the object it intersected, with numerical codes assigned as appropriate.

An analysis of the raw sample length statistics was undertaken to determine an appropriate composite interval length. The analysis was undertaken on all samples contained within mineralised wireframes.

The Lake Cowan deposits were primarily sampled at 1 m intervals, therefore 1 m composites were generated at each deposit. Basic statistics were reviewed and a high CV noted for some domains. Top-cuts were applied to selected domains at each deposit as summarised in

Table 14-74. Top-cuts were applied to a single lode at each of Josephine and Rose whereas 9 of the 13 lodges at Napoleon were capped with values ranging from 10 g/t to 25 g/t.

Table 14-74 Top-cuts applied at Lake Cowan deposits

Deposit	Top-Cut (g/t)		Domains	
	From	To	Cut	Total
Josephine	-	35	1	12
Atriedes	5.5	20	6	9
Louis	-	20	3	23
Napolean	10	25	9	13
Rose	-	3	1	10

14.4.5.5 Density

For all Lake Cowan deposits, bulk density values were taken from previous mining work completed on deposits and assigned by oxidation state. These assumed values are summarised in Table 14-75.

Table 14-75 Density values assigned to Lake Cowan models

Material Type	Average Density (t/m ³)
Transported (paleochannel)	1.8
Oxide	2.1
Transitional	2.4
Fresh	2.86

14.4.5.6 Variography

Traditional variograms were analysed for grade continuity directions. Before calculating the variogram, a normal scores transformation was performed on the data, converting the skewed grade distribution to a standard normal distribution, limiting the influence of extreme grades. For use in the estimation the normal score variogram models were back transformed. Where applicable, domains of similar orientation, geology and statistics were grouped to provide sufficient samples for variogram modelling. The variogram models showed that nuggets were moderate to high at all the deposits.

14.4.5.7 Block Model and Grade Estimation

Block models were created at each deposit, using GEOVIA Surpac™, to encompass the full extent of the deposit. Selected parent block sizes (and sub-blocks) varied across the models and are summarised in Table 14-76. The block sizes selected were based on the results of a kriging neighbourhood analysis (KNA).

Table 14-76 Lake Cowan block models – cell size summary

Deposit	Parent Block Size			Sub-Block Size		
	Y	X	Z	y	x	z
Josephine	10	5	5	1.25	0.625	0.625
Atriedes	10	10	2	1.25	1.25	0.5
Louis	5	2	5	2.5	1	2.5
Napolean	5	5	2.5	0.625	0.625	0.625
Rose	10	10	5	2.5	2.5	1.25

Grade estimation was completed using ordinary kriging (OK) interpolation using GEOVIA Surpac™. The wireframes were used as a hard boundary for the grade estimation of each domain. That is, only grades inside each lode were used to interpolate the blocks inside the lode. An inverse distance squared (ID²) interpolation was used to estimate grade in domains containing few composites.

Search ellipses were aligned parallel to the maximum continuity determined from the modelled variograms. Multiple estimation passes were run, with first pass search distances based on the variogram modelled ranges. The extrapolation was controlled through the interpreted estimation domains and were limited to half the drill hole spacing within the section and half the section spacing between sections.

14.4.5.8 Model Validation

Final grade estimates were validated by statistical analysis and visual comparison to the input drill hole data. The block volume of each domain was also compared to the corresponding wireframe volume to ensure the sub size chosen allows for accurate representation of the mineralisation volumes. Westgold concluded that, overall, the models were fair and representative of the grade within the domains.

Models were also visually assessed by slicing sections through the block model in positions coincident with drilling.

For the main domains, trend swath plots were generated in various orientations across strike, along strike and at elevation.

14.4.5.9 Mineral Resource Classification

The Lake Cowan Mineral Resources were classified in accordance with the JORC Code 2012 guidelines. A reconciliation of this reporting and the CIM Definition Standards (2014) by the Qualified Person shows no material differences.

Westgold provided a generalised statement for the application of Mineral Resource classification across each of the deposits, summarised below.

“Categories were assigned with consideration for the confidence in the tonnage/grade estimations, reliability of input data, confidence in continuity of geology and metal values, quality, quantity and distribution of the data”.

The Resource was classified on the following basis:

- *Adequate levels of drilling and sample density. All material within the defined drilled-out portion of the resource was classified as Indicated.*

- All mineralised zones currently intersected on a single drilling section are considered *Unclassified* and are thus not reportable within the mineral resource.
- A number of lodes were estimated entirely using RAB/Aircore drill holes which defined mineralised zones, however these are not clearly definable by either grade or geological continuity and are also considered *Unclassified*. These lodes are used to flag areas for follow up geological work where mineralisation is present but not fully understood.
- An area is classified as *inferred* where the data density is sufficient to imply mineralization but too sparse to confirm geological and grade continuity. *Inferred* material is not interpolated or extrapolated past 40m grid spacing in all directions from the last known data point.
- Any extrapolated material or any lode that has <30 samples is classified as ‘*unclassified*’ (exploration target) and will not be report as a Mineral Resource.”

Karora reviewed the Westgold Mineral Resource classification and notes the following:

- Josephine – Measured, Indicated and Inferred. Measured at the north and south extents immediately beneath the existing open pit where drilling is approximately 10 m to 15 m spaced. Indicated through areas defined by 20 m spaced drilling. Inferred outside those areas. Mineral potential at the down dip lode extents.
- Atriedes – Measured, Indicated and Inferred. Measured through area defined by 5 m spaced GC drilling and immediately beneath the existing open pit. Indicated assigned across areas defined by 10 m spaced drilling. Inferred assigned at lode extremities.
- Louis – Measured, Indicated and Inferred. Measured assigned to two small areas at the south of the existing open pit. These areas are extensions to lodes that had been previously mined. Indicated was assigned to most of the deposit where drilling is at a nominal 20 m x 20 m spacing. Inferred assigned at the down dip lode extents.
- Napoleon – Measured, Indicated and Inferred. Measured assigned to the northern part of the main lode immediately beneath the existing open pit. Indicated assigned to the down dip extensions of the main steep west dipping lodes that were mined in the open pit and confined to areas drilled at less than 20 m spacing. Inferred assigned to four steeply west dipping hangingwall lodes and two near-vertical lodes, which extend from the existing open pit, and are defined by irregular spaced drilling up to 40 m.
- Rose – All classified as Inferred except for two small lodes that were considered to have mineral potential.

14.4.5.10 Mineral Resource Statement

The Mineral Resource Statement presented herein sets out the Gold Mineral Resource estimate prepared in accordance with the Canadian Securities Administrators’ National Instrument 43-101 and Form 43-101F. The Mineral Resource estimate as set out in Table 14-77 is effective as of September 30, 2023. The Mineral Resource at the Lake Cowan gold deposits has been reported using 0.5 g/t Au cut-off for open pit material and has been depleted for open pit mining.

Table 14-77 Lake Cowan Depleted Mineral Resource using a 0.5 g/t Au cut-off

Area	Measured			Indicated			Measured & Indicated			Inferred		
	kt	g/t	koz	kt	g/t	koz	kt	g/t	koz	kt	g/t	koz
Atriedes	28	1.7	2	148	2.1	10	176	2.0	11	2	1.7	0.1
Josephine	17	1.6	1	70	2.0	4	87	1.9	5	5	2.2	0.4
Louis	9	1.8	1	481	1.5	23	490	1.5	24	51	1.2	2
Napoleon	5	1.7	0.2	106	1.7	6	110	1.7	6	42	2.0	3
Rose										99	1.2	4
Total	59	1.7	3	804	1.7	43	863	1.7	46	200	1.4	9

- 1) Mineral Resources that are not Mineral Reserves do not have demonstrated economic viability. There is no certainty that all or any part of the Mineral Resources estimated will be converted into Mineral Reserves.
- 2) The Measured and Indicated Mineral Resources are inclusive of those Mineral Resources modified to produce Mineral Reserves.
- 3) The Mineral Resource estimates include Inferred Mineral Resources that are normally considered too speculative geologically to have economic considerations applied to them that would enable them to be categorized as Mineral Reserves. There is also no certainty that Inferred Mineral Resources will be converted to Measured and Indicated categories through further drilling, or into Mineral Reserves once economic considerations are applied.
- 4) The Gold Mineral Resources are estimated using a long-term gold price of US\$1,700/oz with a USD:AUD exchange rate of 0.70.
- 5) The Gold Mineral Resource was reported using a 0.5 g/t cut-off grade taking into account variable operational costs associated with the Higginsville Open Pits.
- 6) Classification is according to JORC Code and CIM Definition Standards Mineral Resource classification categories.
- 7) The Mineral Resource is depleted for mining to September 30, 2023.
- 8) To best represent 'reasonable prospects of eventual economic extraction', the Mineral Resource for open pits has been reported within an optimized pit shells at A\$2,429/oz (US\$1,700/oz).
- 9) Mineral Resource tonnage and contained metal have been rounded to reflect the accuracy of the estimate, and numbers may not add due to rounding.
- 10) Gold Mineral Resource estimates were prepared under the supervision of Qualified Person S. Devlin, FAusIMM (Chief Geological Officer, Karora Resources).

14.4.6 Mt Henry

14.4.6.1 Resource Estimation Overview and Tabulation

The Mt Henry Project area is located approximately 75 km south of the Higginsville Mill and comprises four deposits: Mt Henry, Abbotshall, Selene and North Scotia. The Mt Henry Project Mineral Resources were reported by Karora in a Technical Report dated January 30, 2021. The Mt Henry and Abbotshall models were originally completed by Westgold (2017b) and reviewed by Optiro (now Snowden Optiro) in 2020. The Selene and North Scotia models were completed by Optiro in 2020. For all models, resource pit shells were generated to represent RPEEE using a gold price of US\$1,600/oz, with reporting above a cut-off grade of 0.4 g/t inside these economic pit shells. Although the Mt Henry grade zones were defined above a nominal cut-off of 0.7 g/t gold, mineralisation below this cut-off (and above 0.4 g/t) was reported for the 2020 estimate. Detailed pit designs were not undertaken and material outside the economic shells was not classified or reported.

Karora has not completed any drilling or mining at the deposits since the previous report and the models remain unchanged. Updated pit shells have been produced by Karora using revised economic inputs (US\$1,700/oz) and the existing models have been reported within these optimised shells using the same reporting criteria used in 2020. Snowden Optiro has reviewed and endorsed the pit shells and the revised Mineral Resource estimate. Mr. Glacken, FAusIMM (CP), FAIG, MIMMM, remains the Qualified Person for the Mt Henry Project Mineral Resource.

14.4.6.2 Mineral Resource Statement

The Mineral Resource Statement presented herein sets out the Gold Mineral Resource estimate prepared in accordance with the Canadian Securities Administrators' National Instrument 43-101 and Form 43-101F. The Mineral Resource estimate as set out in Table 14-78 is effective as of September 30, 2023.

Table 14-78 Mt Henry Project Mineral Resource Summary as at September 30, 2023

Location	Measured			Indicated			Measured & Indicated			Inferred		
	kt	g/t	koz	kt	g/t	koz	kt	g/t	koz	kt	g/t	koz
Abbotshall	-	-	-	-	-	-	-	-	-	141	2.6	12
Mt Henry	1,051	1.5	51	2,750	1.5	135	3,801	1.5	186	982	1.5	46
Selene	9,992	1.2	373	7,276	1.0	230	17,268	1.1	603	1,438	1.0	48
North Scotia	-	-	-	145	2.6	12	145	2.6	12	3	2.4	0
Total	11,042	1.2	424	10,172	1.2	378	21,214	1.2	802	2,565	1.3	106

- 1) Mineral Resources are not Mineral Reserves and do not have demonstrated economic viability. There is no certainty that all or any part of the Mineral Resources estimated will be converted into Mineral Reserves.
- 2) Mineral Resources have been reported inside economic pit shells, reflecting reasonable prospects of eventual economic extraction (RPEEE), which have been generated at a gold price of US\$1,700/oz, using a cut-off grade of 0.4 g/t gold.
- 3) The Mineral Resource estimates include Inferred Mineral Resources that are normally considered too speculative geologically to have economic considerations applied to them that would enable them to be categorized as Mineral Reserves. There is also no certainty that Inferred Mineral Resources will be converted to Measured and Indicated categories through further drilling, or into Mineral Reserves once economic considerations are applied. Mineral Resource tonnage and contained metal have been rounded to reflect the accuracy of the estimate, and numbers may not add due to rounding.
- 4) The Mineral Resources are based on information compiled by I. Glacken, FAusIMM (CP), FAIG, MIMMM, who is an employee of Snowden Optiro.

14.4.6.3 Resource Estimation Workflow

A conventional Mineral Resource estimation workflow was followed for the Mt Henry resource estimates, using ordinary block kriging within geological and mineralisation wireframes. This is summarised in a visual flowsheet in Figure 14-67.

The workflow for Selene involves the interpretation of weathering and transported material surfaces, mineralised zones and gold grade outlines within key lithological units. The lithological models from the previous estimate have been used as the basis for the generation of mineralisation domains. Following data conditioning, including compositing and capping, densities were applied on the basis of weathering and lithology. Estimation of gold into 17 of 27 separate domains at Selene is by ordinary block kriging, while 10 minor volumetric domains have gold values assigned using the composite average due to the lack of sampling data.

The workflow for the North Scotia area involves interpreting and extrapolating the base of alluvial material, generation, and extrapolation of BIF solids and interpretation of gold mineralisation domains, generally on the basis of grade and lithology. Data conditioning involved the application of caps and statistical analysis. A total of 23 individual mineralised domains were defined, and gold grades were estimated from composite data using a dynamic anisotropy technique. Classification of mineralisation at Selene and Mt Henry was based upon CIM Definition Standard guidelines and considered data (drilling) density, the estimation quality, and geological confidence.

Figure 14-67 Generalised estimation workflow for the Mt Henry Mineral Resource estimates

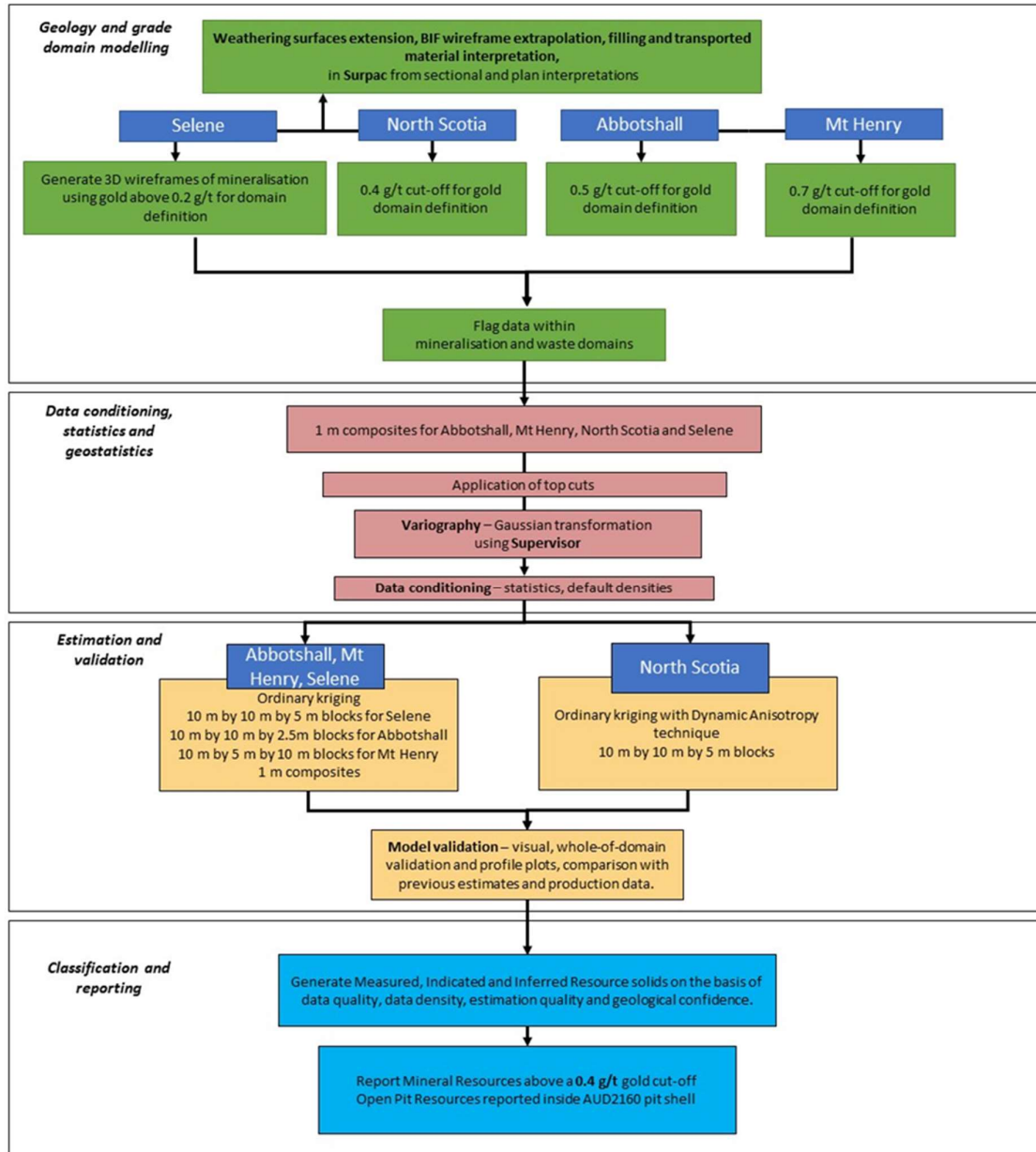

The resource estimates and classification of Abbotshall and Mt Henry were based upon earlier modelling by Westgold, which was reviewed and endorsed by the Qualified Person. These follow the same workflow of definition of weathering surfaces and lithological models, generation of gold mineralisation domains constrained by lithology and cut-off grade, data conditioning and geostatistics followed by ordinary block kriging. The Qualified Person considers the classification of Abbotshall and Mt Henry to be appropriate.

In all cases resource pit shells were generated to represent RPEEE using a gold price of US\$1,700/oz, with reporting above a cut-off grade of 0.4 g/t inside these economic pit shells. Note that although the Mt Henry grade zones were defined above a nominal cut-off of 0.7 g/t gold, mineralisation below this cut-off (and above 0.4 g/t) was reported for the 2023 estimate.

Detailed pit design was not undertaken and material outside the economic shells has not been classified or reported.

The individual estimates at Selene and North Scotia, regenerated in 2020, are described in more detail below.

14.4.6.4 Selene Resource Estimation Details

14.4.6.4.1 Geological Model and Mineralization Domains

Only diamond, reverse circulation and RC/DD holes were used for wireframing. An initial review of the Selene grade distribution based upon all data was undertaken to identify a natural grade cut-off for the onset of mineralisation. The log-probability grade distribution suggested possible cut-offs of 0.2 g/t and 0.4 g/t (Figure 14-68). A cut-off of 0.2 g/t gold was selected to retain the continuity of mineralisation. Mineralisation at Selene area was modelled in GEOVIA Surpac™ using conventional cross-sectional interpretation methods using a nominal 0.2 g/t Au threshold and the geological logging. The sectional interpretations were then compiled into three dimensional wireframes for use in the estimate. A certain amount of waste material was included in the mineralisation domain. To resolve this issue, 22 internal waste sub-domains were created based on the assumption that there should be at least two continuous intervals with less than 0.2 g/t, which could be connected either on the same section or across multiple sections; in other words, the waste has been treated as ‘mineralisation’ during wireframing (Figure 14-69).

Figure 14-68 Cumulative distribution plot of gold grades for raw Selene samples

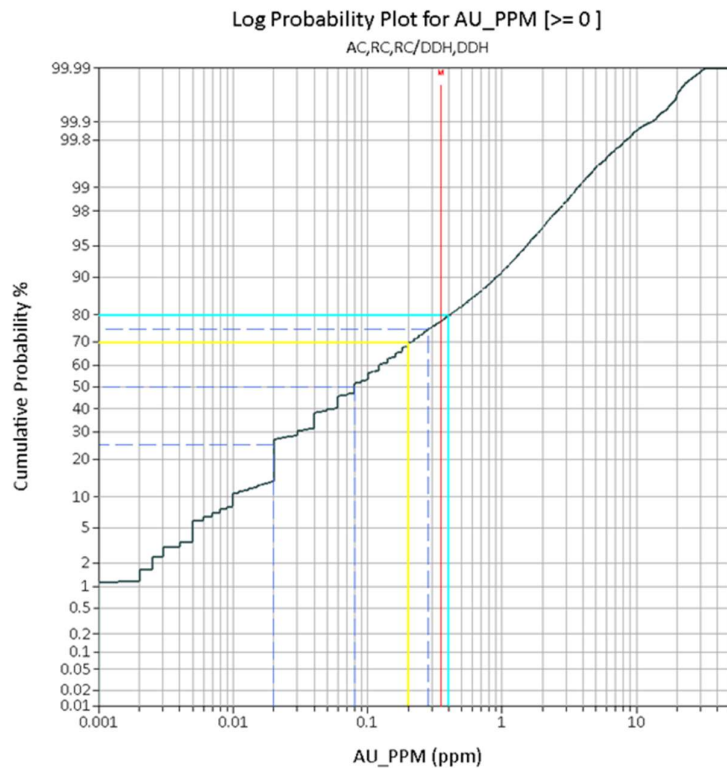
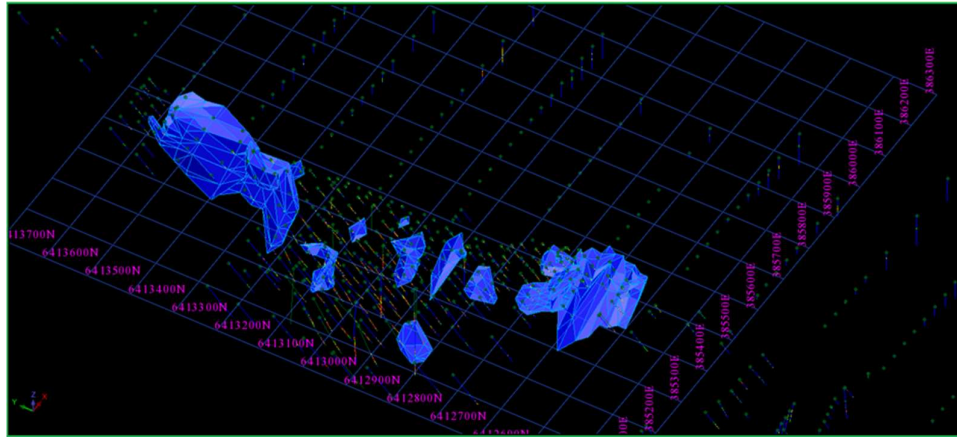

Figure 14-69 3D view, looking northwest, showing Selene drilling and internal waste domains



The available TOFR and BOCO weathering surfaces extended to approximately 6,411,800 mN and did not extend to the southern margin of the North Scotia model area (Figure 14-70). The available lithology and oxidation data (*Lith1_Code*, *Lith_Plot* and *LITH_OXIDATION* fields) were reviewed and it was noted that only a small number of holes had relevant weathering data logged. It was also noted that the existing surfaces stopped approximately 100 m short of the western margin of the Selene and North Scotia model areas. The existing weathering surfaces were extended horizontally 100 m to the west to provide sufficient coverage for the model area. At the margins of the block model, this is not considered a significant risk. For the southern extension, Snowden Optiro digitised the BOCO and TOFR contacts from the available drilling (Figure 14-71) and constructed surfaces from the data. The southernmost string from the previous interpretation was extended to the southern limit of the model area and modified slightly on the basis of the closest available drill hole data. Although unlikely to be locally precise, the approach reflects the general knowledge of weathering in the area. The impact has been reflected in the resource classification.

Figure 14-70 3D view, looking southwest, showing the existing BOCO surface and the model estimation area (in yellow)

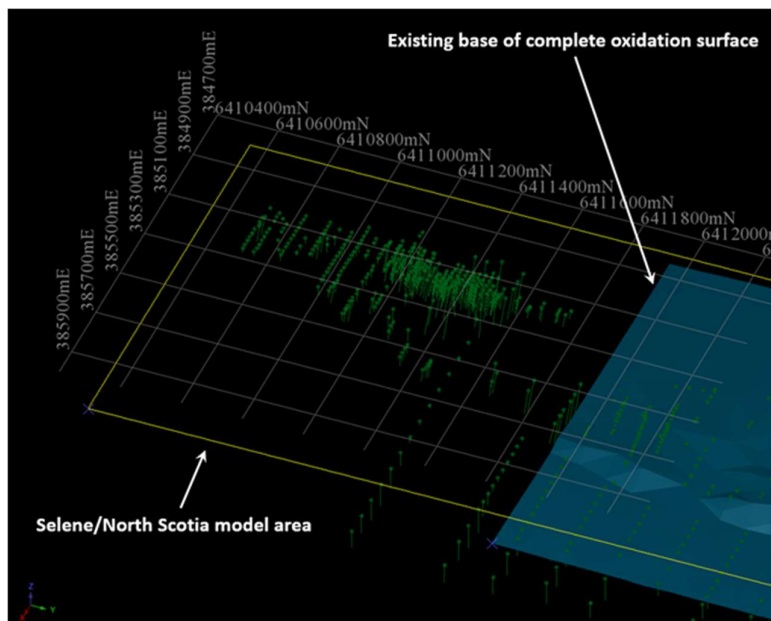
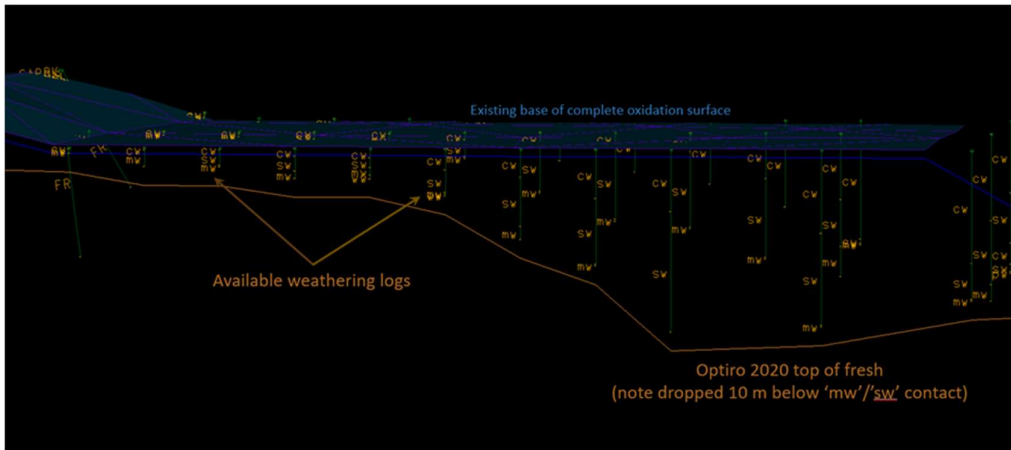
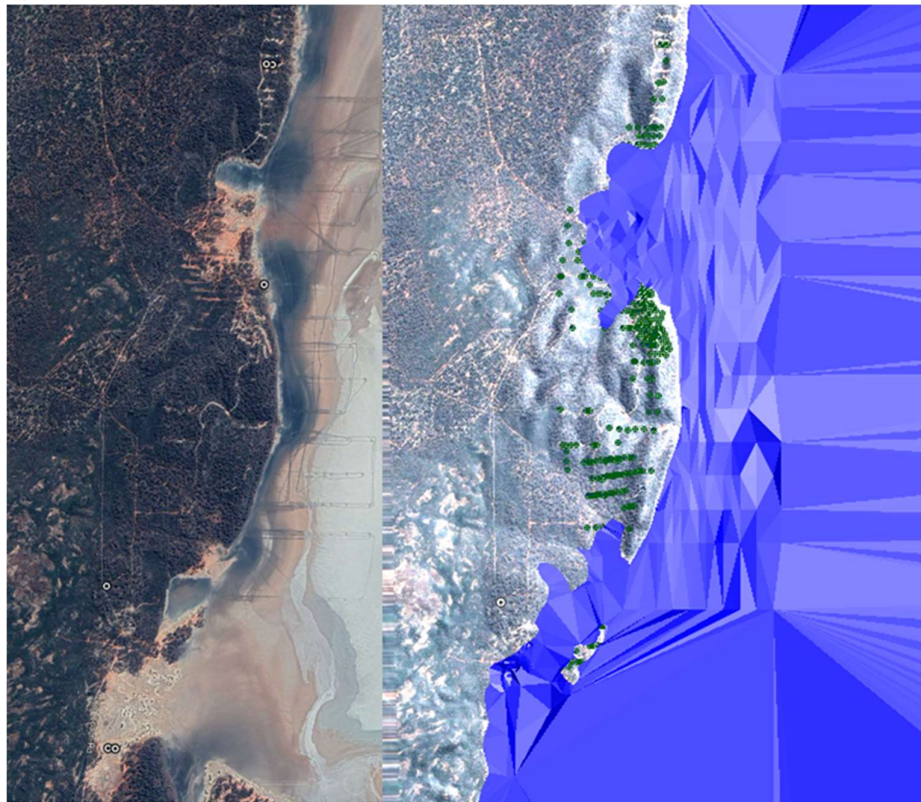

Figure 14-71 Oblique view, looking NNW, showing local modifications to the weathering surface in the Selene/North Scotia area



It was noted that the previous interpretations did not truly reflect the weathering over Lake Dundas, with no deepening of weathering across the lake as would be expected. Assessment of weathering over recently transported lake sediments is difficult. Snowden Optiro constructed the base surface of transported material by digitising the outlines using the coastline in the georeferenced satellite image, control points, air core hole collars, and the transported bedrock contact from DD, RC, and RC/DD lithology logging. The surface was then projected to 150 m higher in RL direction and connected to create a valid solid for coding the block model (Figure 14-72).

Figure 14-72 Satellite image of the Selene/North Scotia area, with (right) and without (left) the transported material interpretation



The Selene Deposit is hosted by a silicate facies BIF unit within the Nogangyer Formation (Bewsher, 2013). Three major mineralisation domains were created reflecting the geology of Selene. Gold mineralisation is predominantly hosted by the silicate facies BIF unit but is also associated with minor meta-basalt and dolerite units that were mostly emplaced in the BIF prior to mineralisation (Figure 14-73). The footwall to the BIF is characterised by a sedimentary schistose unit with continuous mineralisation of 2 m to 4 m width (Figure 14-74) and the hangingwall by the overlying dolerites of the Woolyeener Formation, where the mineralisation is less continuous (Figure 14-75). The mineralisation is infrequently cut by flat lying, dilational barren pegmatite dykes and sills. Both BIF and pegmatite wireframes have been adapted from the previous estimate. The spatial relationship between mineralisation wireframes and BIF is very consistent, although the BIFs are not uniformly mineralised.

Figure 14-73 Selene main mineralisation domain looking northeast

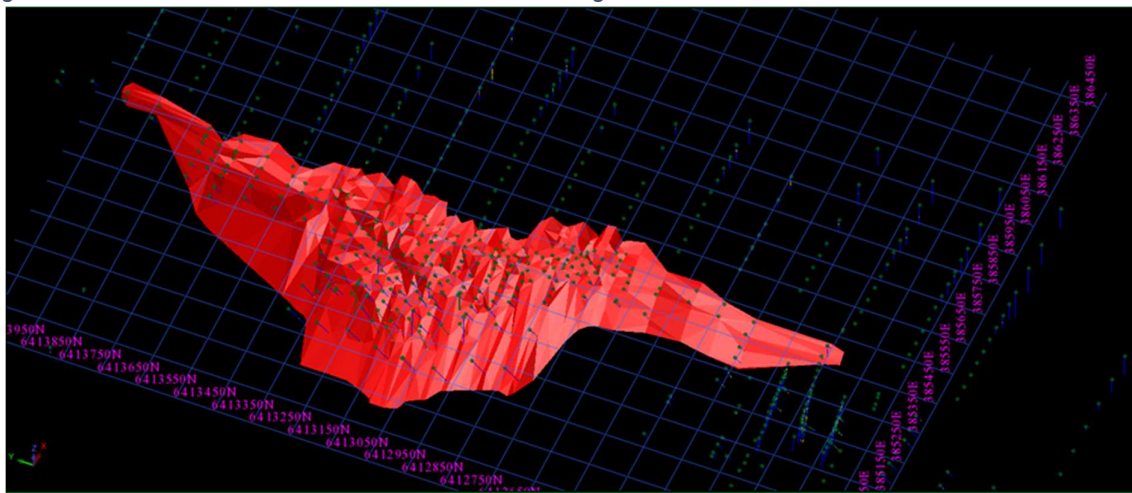

Figure 14-74 Selene footwall mineralisation domain looking northeast

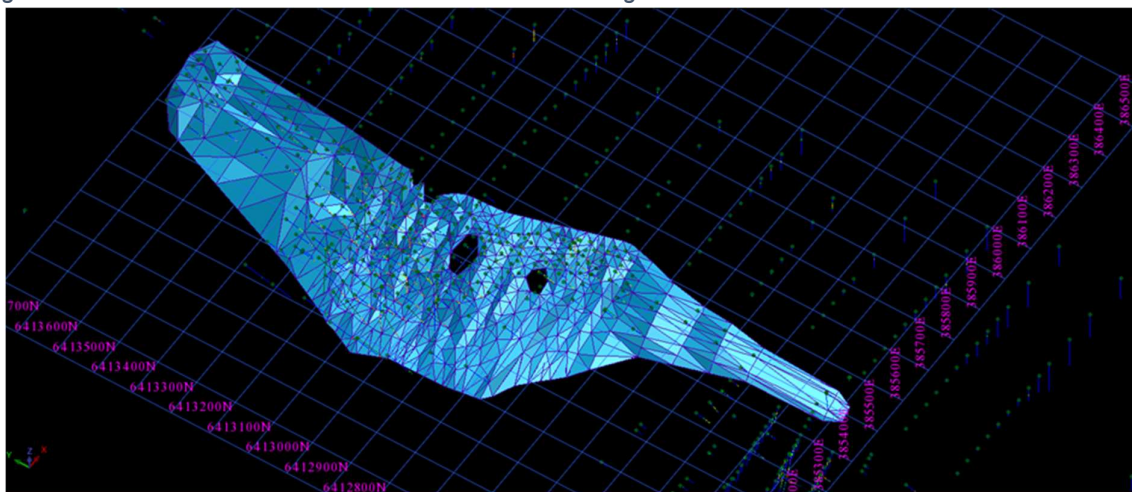
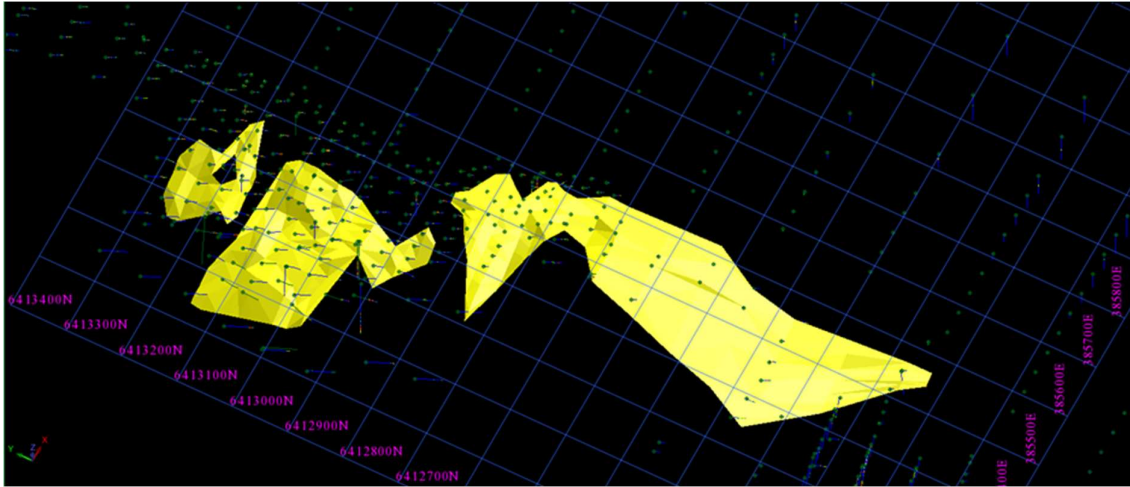

Figure 14-75 Selene hangingwall mineralisation domain looking northeast



A different group of mineralised zones exist to the south of Selene area (Selene South), where the drilling density is much lower than the main Selene mineralisation area; the average drill spacing varies from 50 m to 150 m in the north-south direction, and from 20 m to 40 m in the east-west direction. A total of 24 minor lodes have been interpreted as Selene South (Figure 14-76). Most of the Selene South domains have been assigned to unclassified resources but do provide good exploration targets due to the current sparse drilling space and lack of geology continuity.

No major faults or other structures appear to be present in the Selene or North Scotia area.

Figure 14-76 Selene South mineralisation in plan view (100 m grid squares)

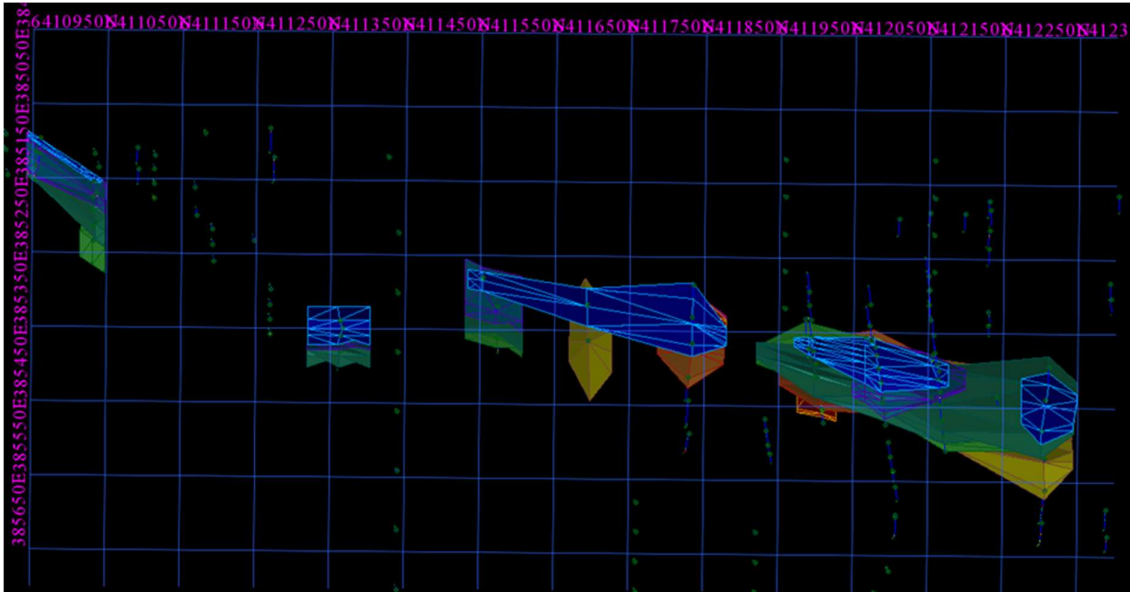

14.4.6.4.2 Data Conditioning

Samples for the Mineral Resource estimate come from a combination of RC, DD and RC/DD drill holes. The dominant downhole sample length in the database is 1 m. Snowden Optiro generated 1m composites for gold, with a minimum composite length of 0.5 m and maximum of 1.5 m.

The application of caps was assessed using both graphical and disintegration techniques. The caps were primarily applied to restrict the impact of individual composites rather than to correct the grade distribution (skew). The caps are detailed in Table 14-79.

Table 14-79 Selene caps (top-cuts)

Lode	No. of samples	Uncut data			Capped data			% Difference			
		Max	Mean	CV	Num cut	Cap (g/t)	Max	Mean	CV	Mean	CV
Main	8259	55.39	0.98	1.63	1	40	40	0.98	1.57	0.0	-3.7
Hangingwall	682	22.74	0.61	2.35	3	10	10	0.57	1.67	-6.6%	-28.9
Footwall	1257	42.3	0.58	2.35	1	20	20	0.57	1.58	-1.7%	-32.8
Sth2420	40	19.5	0.96	3.19	1	10	10	0.72	2.2	-25.0%	-31.0

Exploratory statistical analysis was carried out on the composited data in order to determine the most appropriate estimation techniques. All composites in the three major domains (main, hangingwall and footwall) show relatively low variability in grades and were therefore estimated using ordinary kriging. Due to the lack of data, variography could not be adequately generated for the domains in the south of the Selene area, and the search parameters from the main zone, with decreased sample numbers, were applied to 14 of the 24 Selene South domains. The other 10 domains, which contain fewer than 12 samples on average, and which could not be estimated with reasonable search parameters, were assigned with the average composite values.

14.4.6.4.3 Variography

Ordinary kriging was used to estimate 17 domains in the Selene area. An example of the gold grade variogram for the main domain is presented in Figure 14-77, which depicts the downhole variogram (top left) and the directional variograms for the principal direction (a shallow dip to the east), the intermediate direction (a shallow dip to the north) and the minor direction (a steep dip to the south). The nugget variance is moderate, at 43% of the sill. Overall, nuggets vary between 43% and 74% of the sill. Maximum ranges vary between 44 m and 92 m. The Selene variography is summarised in Table 14-80.

Table 14-80 Summary of Selene variography

Domain	No. Structures	Nugget	Bearing	Plunge	Dip	Sill 1	Range 1	Range 2	Range 3	Sill 2	Range 1	Range 2	Range 3	Sill 3	Range 1	Range 2	Range 3
1000	3	0.429	30	130	80	0.343	27.4	8.4	2.2	0.124	36.6	34.7	4.3	0.103	44.3	36.5	19.7
1100	2	0.495	-	125	90	0.376	15.4	27.2	4.3	0.129	40.9	53.2	12.7	-	-	-	-
1200	3	0.743	20	125	340	0.159	30.2	91.8	4.4	0.0769	56.4	91.9	6.2	0.0206	59.9	92	6.4

Figure 14-77 Gold variograms for the Selene main domain

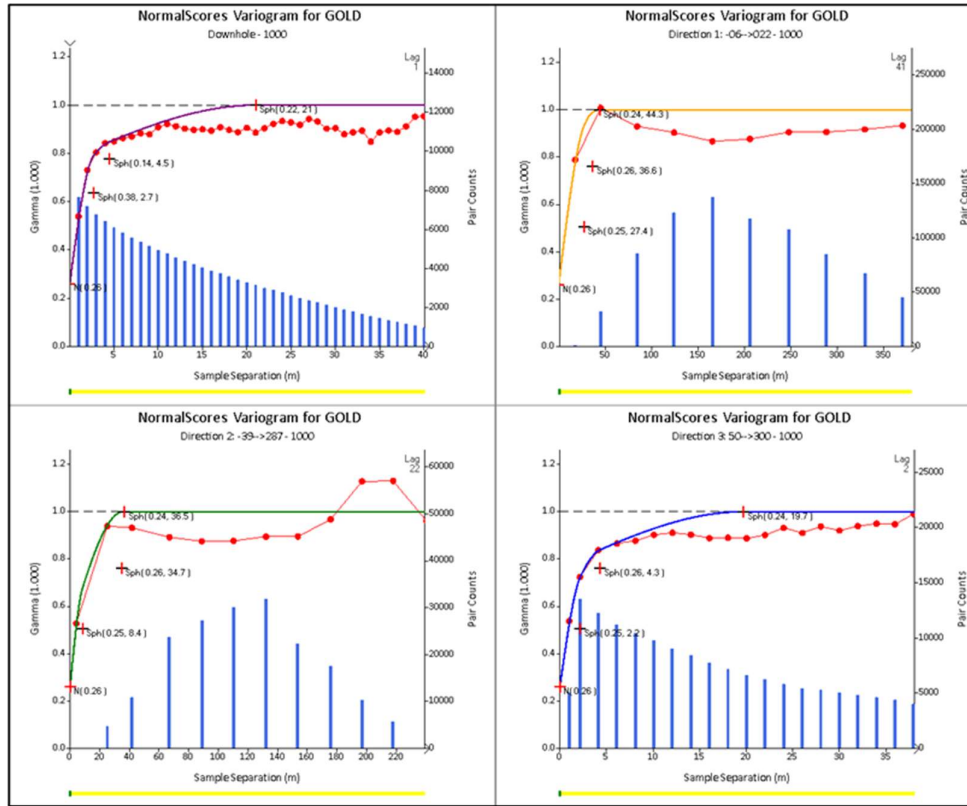

14.4.6.4.4 Grade Estimation

Previous lithology models at Selene were in a local grid. All data points were converted to MGA94 grid for this update estimation, using the following transformation points:

- Point 1: north 10,880.00 mN to 6,418,937.30 mN, east 5,000.00 mE to 385,922.10 mE; and
- Point 2: north 3,040.00 mN to 6,411,115.60 mN, east 4,240.00 mE to 385,015.00 mE.

The model origin and extents are documented in Table 14-81. The block size of 10 mX x 10 mY x 5 mZ was selected based on kriging neighbourhood analysis (KNA), with consideration of mining dimensions and selectivity, while the sub-blocking was set to ensure no material volumes were created or lost during the block model creation.

Table 14-81 Summary of Selene and North Scotia model origin and extents

Axis	Minimum block centre coordinate	Maximum block centre coordinate	Parent block size (m)	Number of blocks	Minimum sub-block size (m)
Easting (X)	384,680	386,020	10	134	0.625
Northing (Y)	6,410,500	6,414,100	10	360	1.25
Elevation (Z)	40	295	5	51	2.5

KNA was also used to optimise the estimation parameters, specifically the size of the search ellipsoid and the minimum and maximum number of samples required for estimation. In general, four search ellipsoids were used to estimate gold grades in each domain. The initial search ellipsoid was set to the size of the variogram ranges in each of the principal directions and used between 12 and 30 samples for the major lodes. The second search featured an expanded

search ellipsoid (generally 100% larger) with same number of samples (between 12 and 30). The third and fourth searches were conducted with larger search ellipsoid (400% to 600% of first search distance) and decreased number of samples (between 6 and 15).

The direction 1 and 2 search distances were set to the same in the Selene South lodes, resulting in an effective estimation 'disc'. For the lodes with fewer than 18 but not fewer than 12 samples, a minimum of 4 and a maximum of 8 samples were used during estimation. The domains with more than 18 samples used a minimum of 8 and a maximum of 24 samples. Approximately 78% of the blocks were estimated by the first pass.

The available density data were reviewed, and the pycnometer density data were excluded. The bulk density values used in this estimate are summarised from both the previous model estimate completed by Cube Consulting in 2017, and the density values provided in the database (Table 14-82). The density assignment starts with the field 'rock', and then ends up with 'lode'. In other words, for the blocks having two different densities, the 'lode' will overwrite the 'rock' value. The Qualified Person considers this to reflect the difference between mineralisation and barren from the density perspective.

Table 14-82 Details of Selene density assignment

Rock type	Lode	Rock	Transported		Oxide		Transition		Fresh	
			No. Samples	Average	No. Samples	Average	No. Samples	Average	No. Samples	Average
Filling	(blank)	fill	N/A	1.5	N/A	N/A	N/A	N/A	N/A	N/A
Transported	(blank)	transported	3	1.5	N/A	N/A	N/A	N/A	N/A	N/A
Hangingwall basalt	(blank)	hwmb	N/A	N/A	N/A	2.1	N/A	2.4	N/A	2.7
Footwall sediment	(blank)	fwsed	N/A	N/A	2	1.4	11	2.1	123	2.8
Internal basalt	(blank)	intrmb	N/A	N/A	N/A	2.1	N/A	2.4	N/A	2.7
BIF	(blank)	bif	N/A	N/A	N/A	2.6	N/A	2.9	48	3.1
Pegmatite	(blank)	peg	N/A	N/A	N/A	2.2	N/A	2.4	71	2.6
Internal waste	internalwaste	(blank)	N/A	N/A	N/A	2.6	N/A	2.9	36	3.2
Min.main	main_min	(blank)	N/A	N/A	N/A	2.6	N/A	2.9	494	3.2
Min.HW	hw_min	(blank)	N/A	N/A	N/A	2.5	N/A	2.8	43	3.1
Min.FW	fw_min	(blank)	N/A	N/A	N/A	2.5	N/A	2.8	41	3.1
Min.Selene Sth	sth2000	(blank)	N/A	N/A	N/A	1.4	N/A	2.1	N/A	2.8

14.4.6.4.5 Model Validation

Optiro completed a block model validation in 2020. There has been no change to the model for 2023, thus the previous discussion relating to model validation is reproduced below, using the US\$1,600 pit shell.

The block model was visually validated against the informing composites and the RPEEE pit shell (see example in Figure 14-78). Validation was carried out in both plan and cross-section. In addition to the visual validation, numerical validation was carried out, both at the whole-of-domain level (comparing average cut and composited sample grades with volume-weighted model grades, Table 14-83) and via swath or profile plots (Figure 14-79). The swath plots compare the average volume weighted model grades against the capped and de-clustered drill hole grades and show the number of samples used in each slice. The swath plots were generated for the easting, northing, elevation and along strike dimensions and show that the

broad grade trends in the drill hole data are reproduced in the block models, albeit with some smoothing inherent to the estimation approach.

Figure 14-78 Visual validation example for Selene block model at 6,413,145 mN

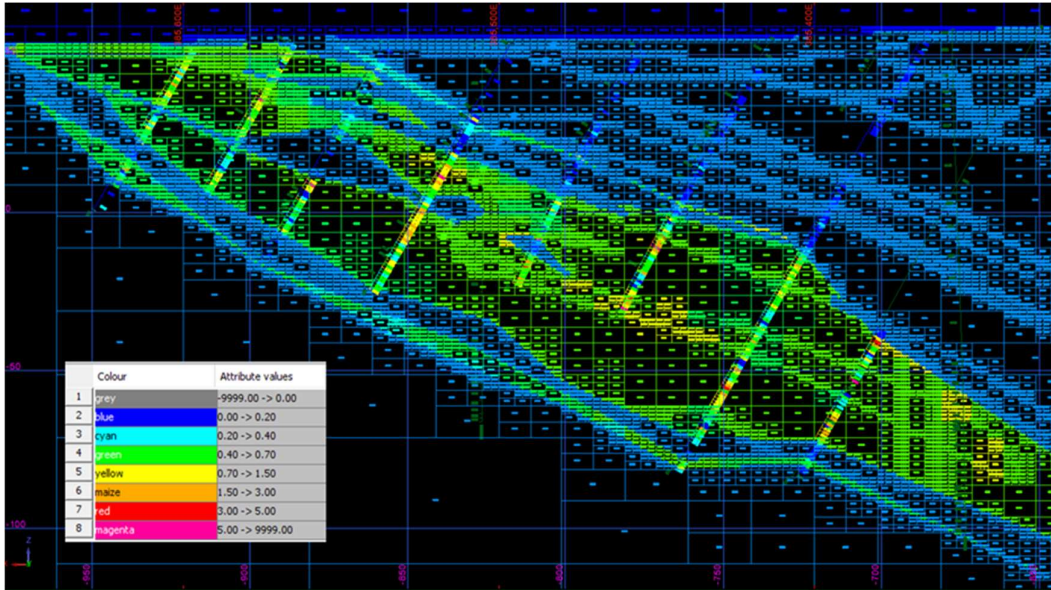
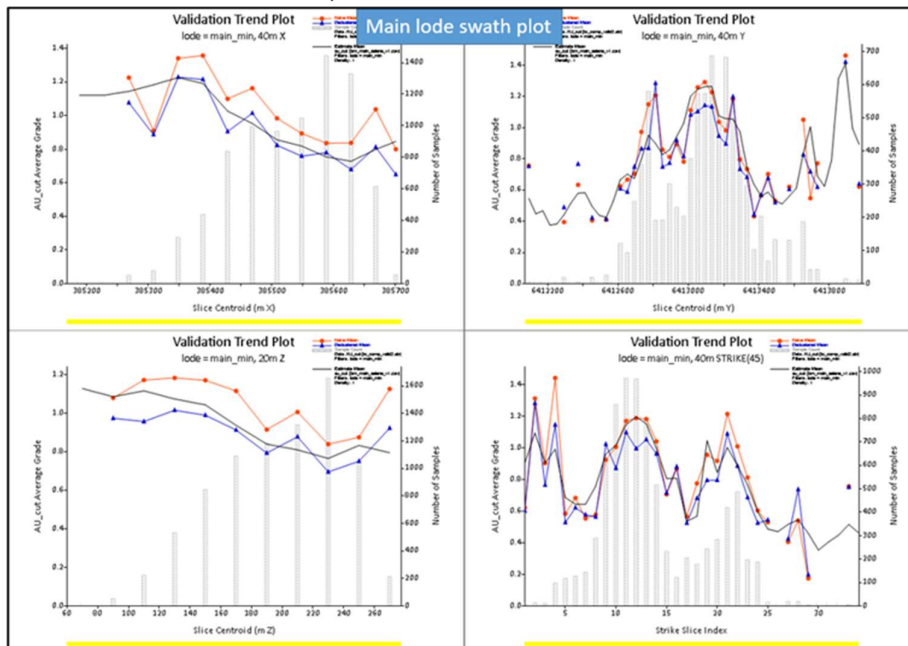

Table 14-83 Selene whole-of-domain validation

Domain	Mean composite top-cut (g/t Au)	De-clustered composite top-cut (g/t Au)	Block model estimate (g/t Au)	Estimate vs composite %Diff	Estimate vs de-clustered %Diff
Main	0.99	0.85	0.91	-7.94	8.12
Hangingwall	0.58	0.54	0.49	-14.72	-9.64
Footwall	0.57	0.57	0.56	-1.66	-2.18

Figure 14-79 Selene main domain swath plots



14.4.6.5 North Scotia Resource Estimation Details

14.4.6.5.1 Geological Model and Mineralization Domains

The October 2020 North Scotia interpretations adjusted the pre-existing rock and weathering interpretations supplied by Karora. The existing North Scotia BOA interpretation was extended north and south (Figure 14-80) and adjusted for available drilling, snapped to the transported-bedrock contact.

Figure 14-80 North Scotia plan view showing the extended 2020 base of alluvial sediment interpretation

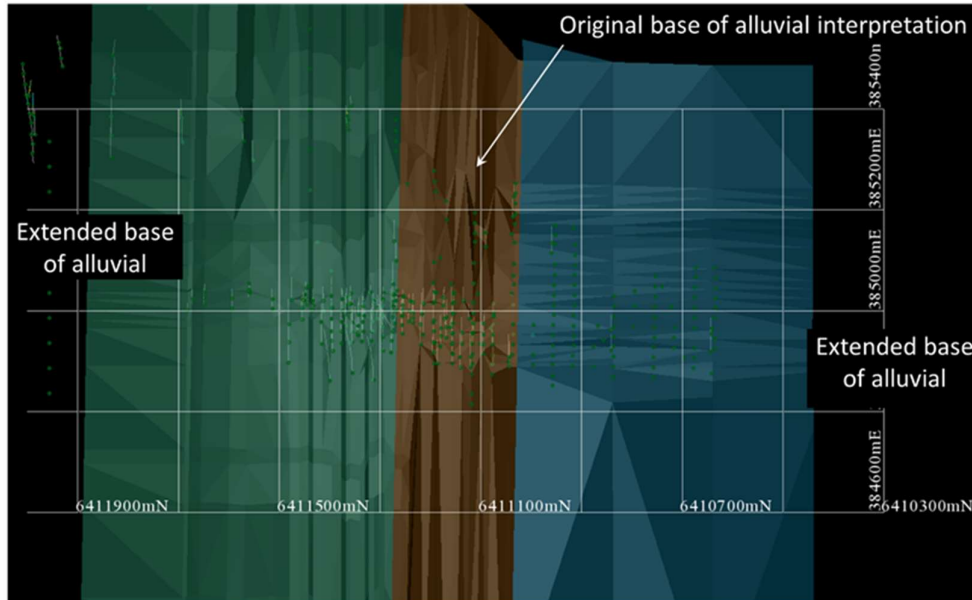

All of the North Scotia mineralisation is located in the Selene hangingwall basalt unit. The Selene BIF extends into the North Scotia area at depth, but drilling south of Selene has not intersected the BIF south of 6,411,740 mN. The southernmost existing BIF section was extrapolated south to ensure appropriate coverage for the block model. Material stratigraphically above and below the BIF was then coded as either hangingwall basalt or footwall sediment, respectively. The BIF stratigraphy was significantly deeper than the North Scotia mineralisation. A 3D view of the North Scotia mineralisation is shown in Figure 14-81.

Figure 14-81 View of North Scotia looking to the northwest showing the interpreted domains and the extrapolated Selene BIF

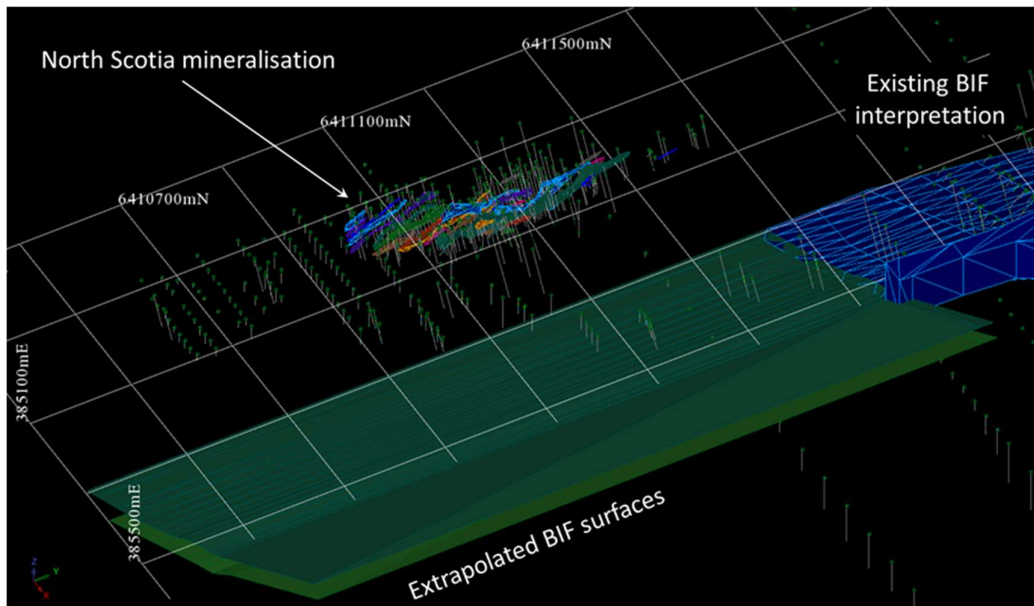

The North Scotia pegmatite interpretation was used to code the North Scotia area samples and block model. The same extended weathering surfaces as used for the Selene update were used for the North Scotia area.

A graph of the North Scotia raw grade distribution was undertaken to identify a natural grade cut-off grade for the onset of mineralisation. The log-probability grade distribution suggested a cut-off between 0.3 g/t to 0.4 g/t when reviewed spatially (Figure 14-82). A cut-off of a nominal 0.4 g/t gold was selected to define the onset of mineralisation. However, a significant amount of below 0.4 g/t material has been included, both as low grade internal to the mineralisation, as well as to derive up and down dip continuity in particular.

In preparing the interpretations, it was very difficult to reliably identify, in 3D, a steep, north-south strike continuity at North Scotia. Several attempts were trialed using the north-south orientation, but none were compelling. It was noted that there are numerous RC holes that had two or fewer downhole survey measurements, which exacerbate the relative geometric changes observed at North Scotia and result in inconsistencies in the interpretations, which is common in mixed datasets.

The option of using a categorical indicator approach was trialed, but also failed to deliver any along strike continuity. However, there was some evidence of a more oblique orientation (Figure 14-82) which prompted further reviews of the data.

Figure 14-82 North Scotia global gold composites for cut-off grade analysis (left) and horizontal continuity fan of an 0.3 g/t indicator (right)

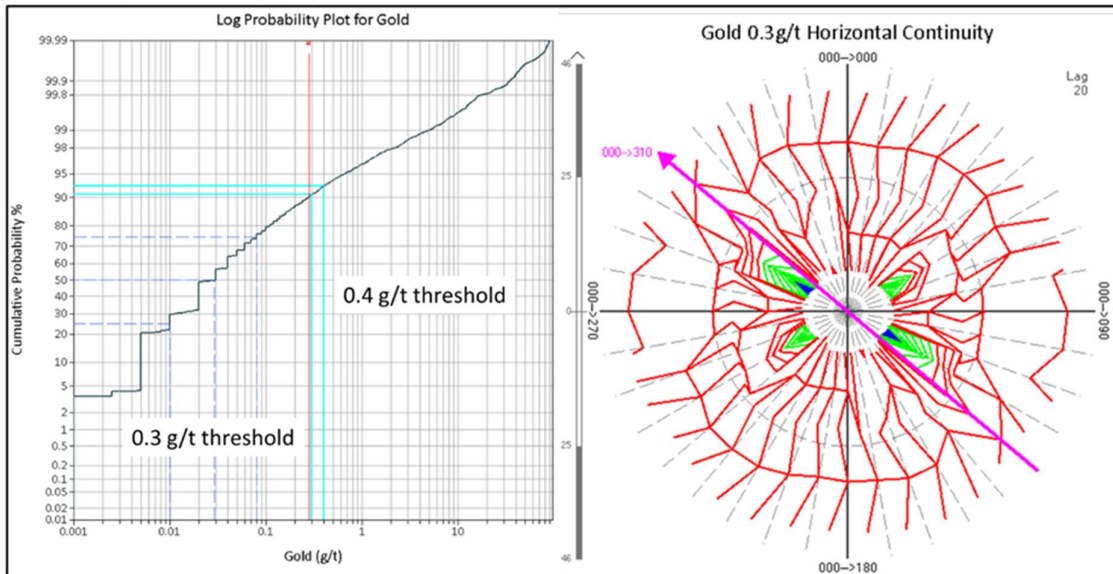

The data were reviewed again spatially, and an orientation of between of 335° and 350° provided evidence of greater along-strike continuity, with dips that ranged from steep to less than 45°. This orientation was tested, refined and gradually a series of anastomosing interpretations was built up which had a greater 3D continuity than previously observed.

After completion of the interpretation of the continuous mineralised lodes, it was noted that there were numerous higher-grade intersections that could not be linked up in 3D, especially along strike. To provide some information for future exploration planning, 3D polygons that reflected the local geometry were constructed and extended half a section along strike. These isolated lodes have been termed 'polygon lodes'.

An oblique view looking down dip is presented in Figure 14-83 and with the lodes coloured by lode type in Figure 14-84. The mineralisation presents as anastomosing, arcuate shapes, suggesting a possible en-echelon arrangement of the lodes within a broader structural corridor.

Figure 14-83 North Scotia broader oblique view of lodes looking in plan view

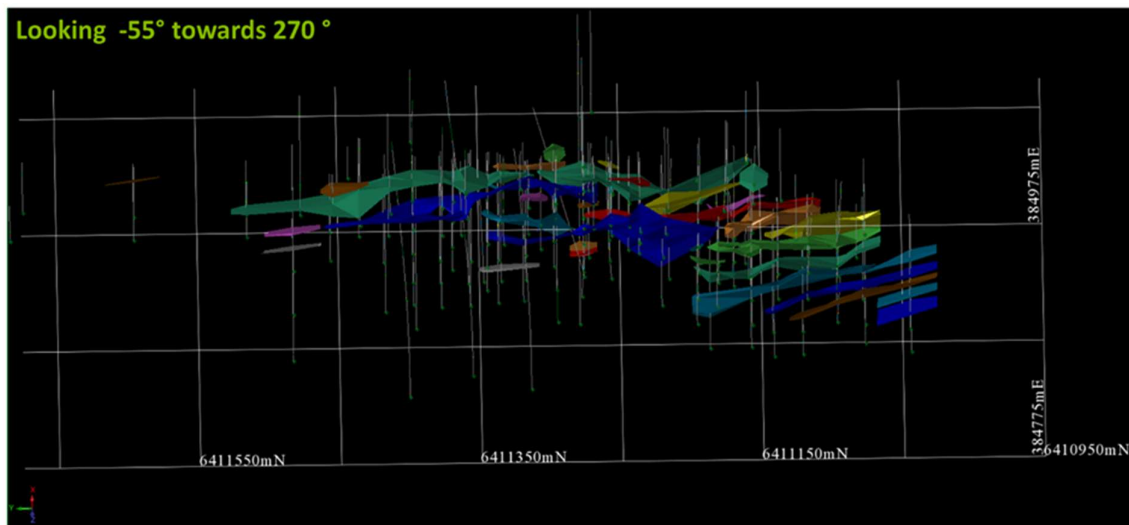
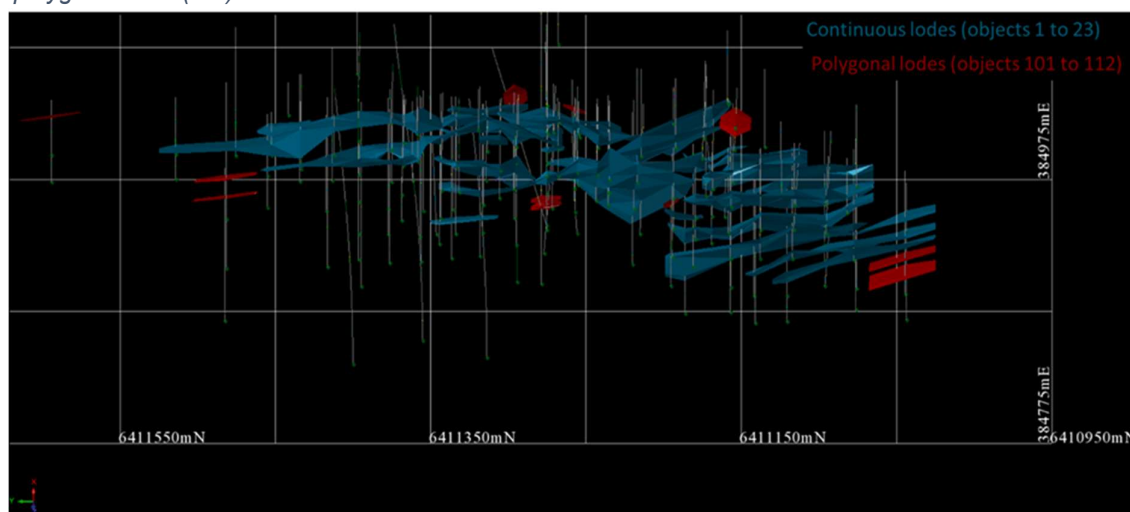

Figure 14-84 North Scotia broader oblique view looking down dip – solids coloured continuous lode (cyan) or polygonal lode (red)



The final mineralised interpretations are not necessarily unique, and there is a range of alternative interpretations, all of which result in mineralised geometries with very limited along strike continuity. Hence the interpretations represent a lower-than-expected confidence given the amount of data available and for the subsequent estimate.

14.4.6.5.2 Data Conditioning

The interpreted solids were intersected with the available valid drilling at North Scotia and the intersections in a MS Access table. The intersections were then used to create the composite files with a composite length of 1.0 m and a minimum composite value of 50%.

The caps were reviewed for the individual continuous lodes and cap values selected primarily using the disintegration technique. Due to the lack of sample numbers, a global cap was applied to all polygonal lodes. Caps for the waste domain were also reviewed and a cap value selected primarily to restrict the variability and reduce the skew of the distribution (Table 14-84).

Table 14-84 North Scotia cap values

Type	Lode	No. of samples	Uncut data			Capped data					% Difference	
			Max	Mean	CV	Num cut	Cap (g/t)	Max	Mean	CV	Mean	CV
Continuous lodes	6	26	34.62	2.3	3.0	1	10.0	10.00	1.3	1.9	-41.3%	-36.9%
	11	105	29.00	1.9	2.0	1	20.0	20.00	1.8	1.8	-4.5%	-9.6%
	12	44	15.66	1.2	2.0	1	12.0	12.00	1.2	1.7	-6.7%	-14.2%
	13	147	90.21	5.3	2.4	7	30.0	30.00	4.1	1.9	-23.0%	-23.9%
Polygonal		60	38.47	4.5	1.9	3	25.00	25.00	4.1	1.8	-9.5%	-7.9%
Waste		11,355	18.95	0.1	4.0	46	1.00	1.00	0.1	1.9	-10.0%	-53.3%

14.4.6.5.3 Variography

Due to the relatively small number of available samples, variography was prepared for the consolidated continuous lodes only. This was undertaken by consecutively translating each individual continuous lode by 100 m in easting. Normal-score variography was then prepared, using spherical models exclusively, and applying a normal-score back-transform to real world variances. The applied variogram model is presented in Table 14-85.

Table 14-85 North Scotia variogram model derived from continuous lodes

Variogram type	Direction	Rotations	Nugget (C0)	Structure 1		Structure 2	
				C1	A1 m (ratio)	C2	A2 m (ratio)
Back transformed	-20°/174°	173.6164	0.85	0.083	5.3	0.068	51.8
	68°/144°	-19.6835			(1.387)		(3.602)
	10°/260°	-79.3724			(1.082)		(10.157)

The implication of a flat plunge to the south is similar to the overall mineralised geometry (Figure 14-85). The nugget structure based on the downhole variogram is extremely high, but is not unexpected for Norseman style mineralisation. The implication is that there is limited confidence in any single sample and attempts to try and selectively mine the deposit at an elevated grade cut-off is considered a high-risk proposition.

Figure 14-85 Long-section of North Scotia (looking east) showing mineralisation and direction of maximum continuity for variography

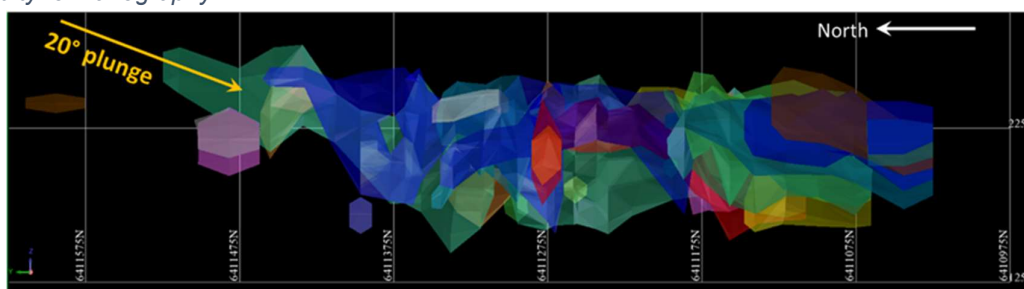

14.4.6.5.4 Grade Estimation

The North Scotia model was constructed as a subset of the Selene block model and used the Selene block model origin and minimum sub-block sizes.

The solid versus block model volume comparisons are presented in Table 14-86. For the continuous lodes the difference ranged from -39 m³ to 71 m³, which equated to -2.8% to 0.8% relative difference, which is considered appropriate.

Table 14-86 North Scotia – block model versus solid volume comparison

Type	Lode ranges	Solid volume	Block model volume	Volume difference	% difference
Continuous	NSC-1 to NSC-23	224,550	224,775	225	0.10%
Polygonal	NSC-101 to NSC-112	11,565	11,585	20	0.17%

As a function of the relatively low cap values, the low skew and the moderate CVs, grade estimation was by ordinary kriging, using the capped composite data.

Due to the variable geometry of the continuous lodes, a dynamic anisotropy method with a horizontal plunge was applied to the search and variogram, as summarised in Table 14-87. Dynamic anisotropy uses a local dip and dip direction to align the search ellipsoid with the lode dip and strike for each block to be estimated.

For the continuous lodes, a wireframe centreline was created from the block model, which was then used to assign the dip and dip direction. For the polygonal lodes, the dip and dip directions were measured from the respective solids. To simplify the estimation process, dynamic

anisotropy was also applied to the waste using the naive average dip and dip direction of the continuous lodes.

Because of the limited number of samples in each domain, equal distances were used for direction 1 and 2 of the search, resulting in an effective estimation 'disc'. A primary search of 25 m was trialled, but again, there were too few composites in each lode to reliably estimate a grade for a domain with such a high nugget. The number of samples and search radius are presented in Table 14-88.

As a function of the variable number of informing samples in each lode and hole spacing, a four-pass expanding search scheme was used for estimation. Any cell not receiving an estimate after the last estimation pass, is assigned the nearest block grade of that lode. Overall, more than 96% blocks of the continuous lodes were estimated during the first pass.

Table 14-87 North Scotia – dynamic anisotropy direction summary

Lode	Lode	Dip Directions			Dip		
		Min.	Max	Average	Min.	Max	Average
Continuous	NSC-1	242	259	250	-69	-46	-57
	NSC-2	230	275	255	-74	-45	-60
	NSC-3	234	274	254	-71	-90	-53
	NSC-4	226	314	261	-70	-45	-55
	NSC-5	241	309	265	-74	-41	-55
	NSC-6	238	304	257	-67	-38	-47
	NSC-7	215	283	255	-70	-36	-50
	NSC-8	224	309	263	-71	-90	-52
	NSC-9	220	303	261	-68	-46	-62
	NSC-10	262	281	270	-69	-57	-65
	NSC-11	224	313	267	-73	-43	-60
	NSC-12	243	311	278	-68	-38	-55
	NSC-13	229	309	279	-73	-39	-59
	NSC-14	256	298	269	-54	-45	-51
	NSC-15	246	280	260	-52	-38	-46
	NSC-16	257	279	271	-60	-45	-54
	NSC-17	270	300	282	-70	-59	-64
	NSC-18	270	270	270	-42	-42	-42
	NSC-19	259	263	261	-72	-64	-68
	NSC-20	241	260	252	-74	-58	-68
	NSC-21	218	330	265	-73	-90	-46
	NSC-22	260	300	289	-64	-56	-59
	NSC-23	234	302	269	-73	-90	-62
	Average ⁽¹⁾	231	303	265	-71	-57	-55
Polygonal	NSC-101	249	249	249	-74	-74	-74
	NSC-102	250	250	250	-68	-68	-68
	NSC-103	273	273	273	-88	-88	-88
	NSC-104	260	260	260	-32	-32	-32
	NSC-105	284	284	284	-60	-60	-60
	NSC-106	262	262	262	-64	-64	-64
	NSC-107	257	257	257	-56	-56	-56

Lode	Lode	Dip Directions			Dip		
		Min.	Max	Average	Min.	Max	Average
	NSC-108	262	262	262	-62	-62	-62
	NSC-109	260	260	260	-61	-61	-61
	NSC-110	258	258	258	-54	-54	-54
	NSC-111	252	252	252	-72	-72	-72
	NSC-112	240	240	240	-44	-44	-44
	Average ⁽¹⁾	258	258	258	-65	-65	-65
Waste		264			-56		

1) Average values are volume weighted.

Table 14-88 North Scotia – estimation parameter summary

	Estimation pass			
	1	2	3	4
Min - max samples	8 - 36	8 - 36	4 - 18	1 - 18
Search ranges 1-2-3	50 - 50 - 10	75 - 75 - 15	100 - 100 - 20	125 - 125 - 25

The mineralisation at North Scotia is described as quartz veining within the basalt and as such, Snowden Optiro elected to assign the densities as in Table 14-89.

Table 14-89 North Scotia – assignment of dry bulk density values

Rock	Weathering	Density (t/m ³)
Transported	N/A	1.5
HW Mb (incl mineralisation)	Cox	2.1
	Partial	2.4
	Fresh	3.0
Mineralisation	Cox	2.1
	Partial	2.4
	Fresh	2.7
BIF	Cox	2.6
	Partial	2.9
	Fresh	3.1
FW Sed	Cox	1.4
	Partial	2.1
	Fresh	2.8
Pegmatite	Cox	2.2
	Partial	2.4
	Fresh	2.6

1) Cox = base of complete oxidation

14.4.6.5.5 Model Validation

Optiro completed a block model validation in 2020. There has been no change to the model for 2023, thus the previous discussion relating to model validation is reproduced below, using the US\$1,600 pit shell.

The North Scotia block model was visually validated against the informing composites and the RPEEE pit design (see example in Figure 14-86 and Figure 14-87). Validation was carried out in both plan and cross-section. In addition to the visual validation, numerical validation was carried out, both at the whole-of-domain level (comparing average cut and composited sample grades with volume-weighted model grades, Table 14-90) and via swath or profile plots (Figure 14-88 and Figure 14-89). The swath plots compare the average volume weighted model grades against the top-cut and de-clustered drill hole grades and show the number of samples used in each slice. The swath plots were generated for the easting, northing, elevation, and cross-strike dimensions and show that the broad grade trends in the drill hole data are reproduced in the block models, albeit with some smoothing inherent to the estimation approach.

Table 14-90 North Scotia – whole-of-domain validation for selected key zones

Domain	Mean composite top-cut (g/t Au)	De-clustered composite top-cut (g/t Au)	Block model estimate (g/t Au)	Estimate vs composite %Diff	Estimate vs de-clustered %Diff
NSC-8	1.84	1.38	1.44	-21.93	4.15
NSC-13	5.29	3.85	3.93	-25.58	2.31
NSC-21	1.14	1.22	1.16	1.89	-5.23
NSC-23	4.39	2.77	2.46	-44.09	-11.46

Figure 14-86 North Scotia block model constrained within RPEEE shell

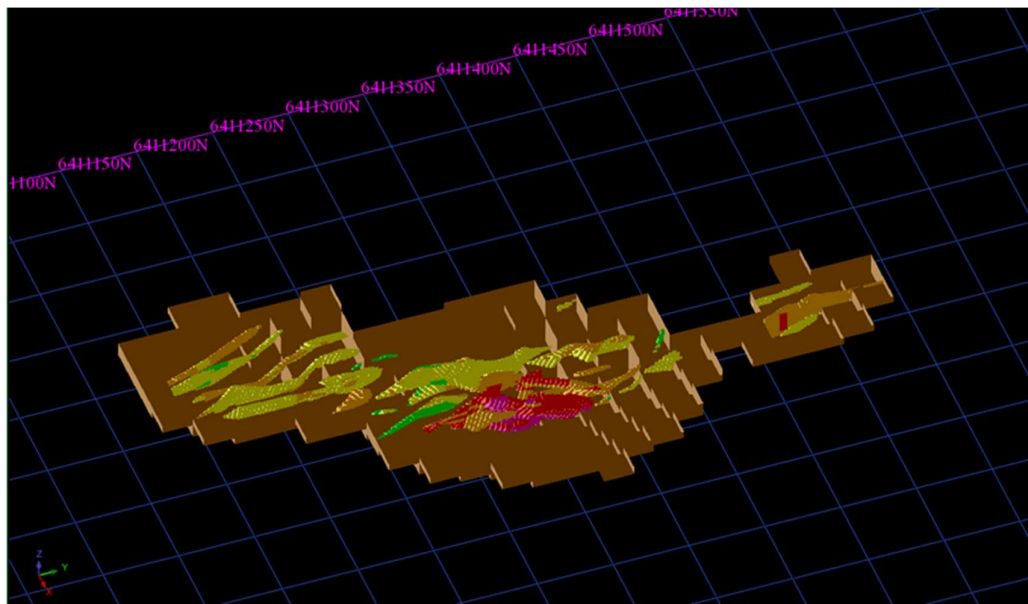

Figure 14-87 North Scotia block model on section at 641,1200 mN, looking north, and informing drill holes

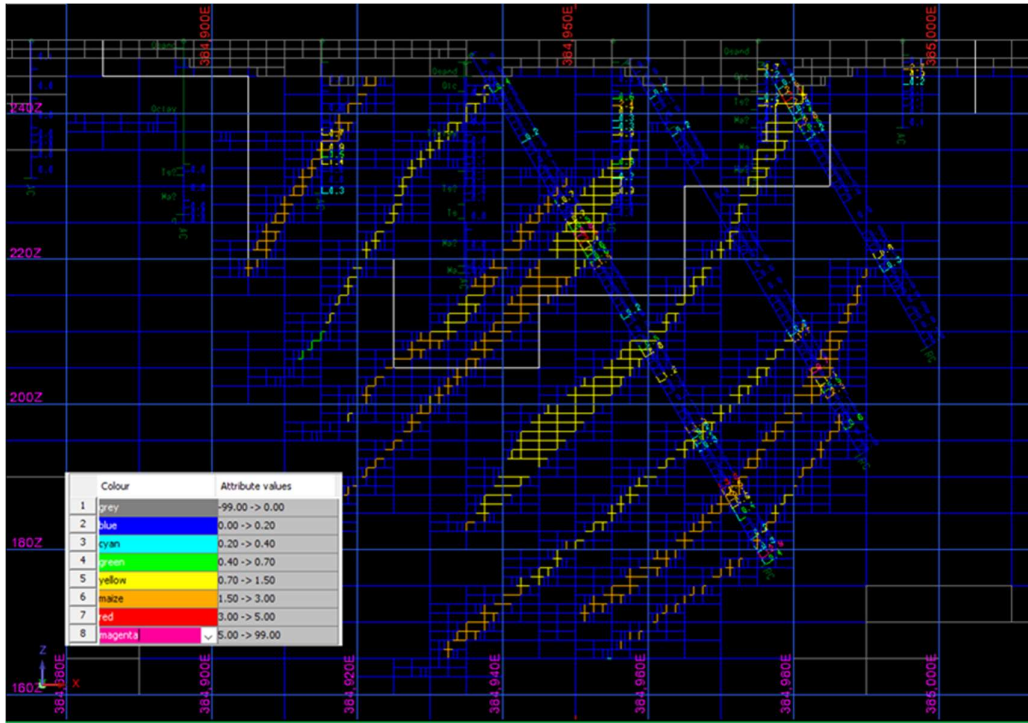

Figure 14-88 North Scotia block swath plot validation for Domain NSC-8

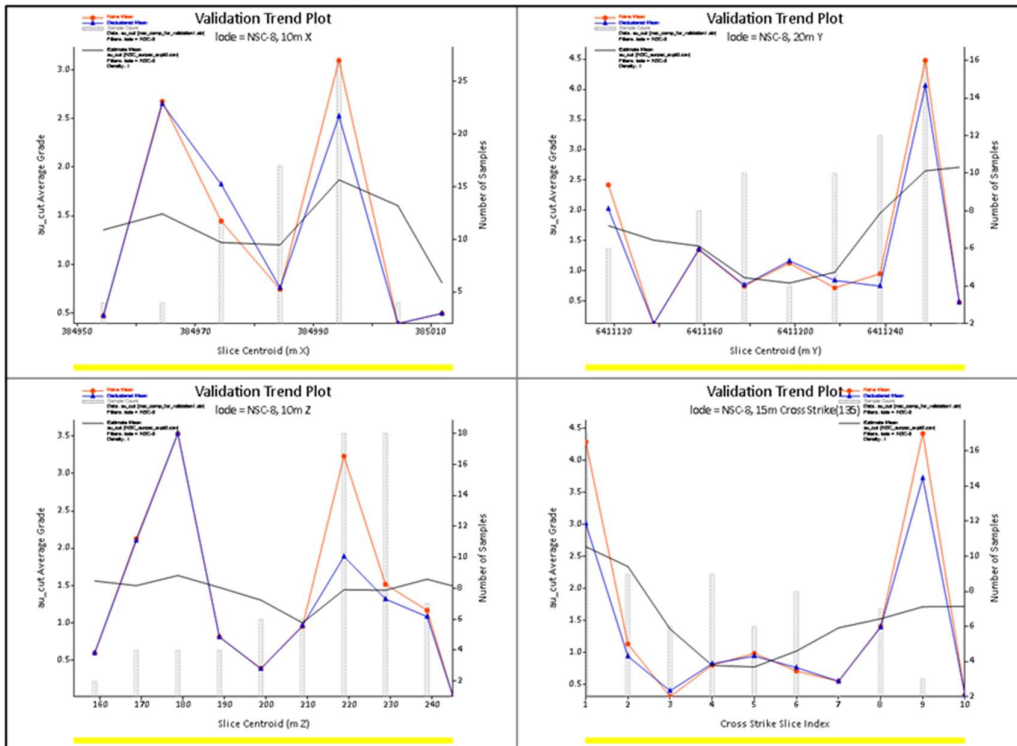
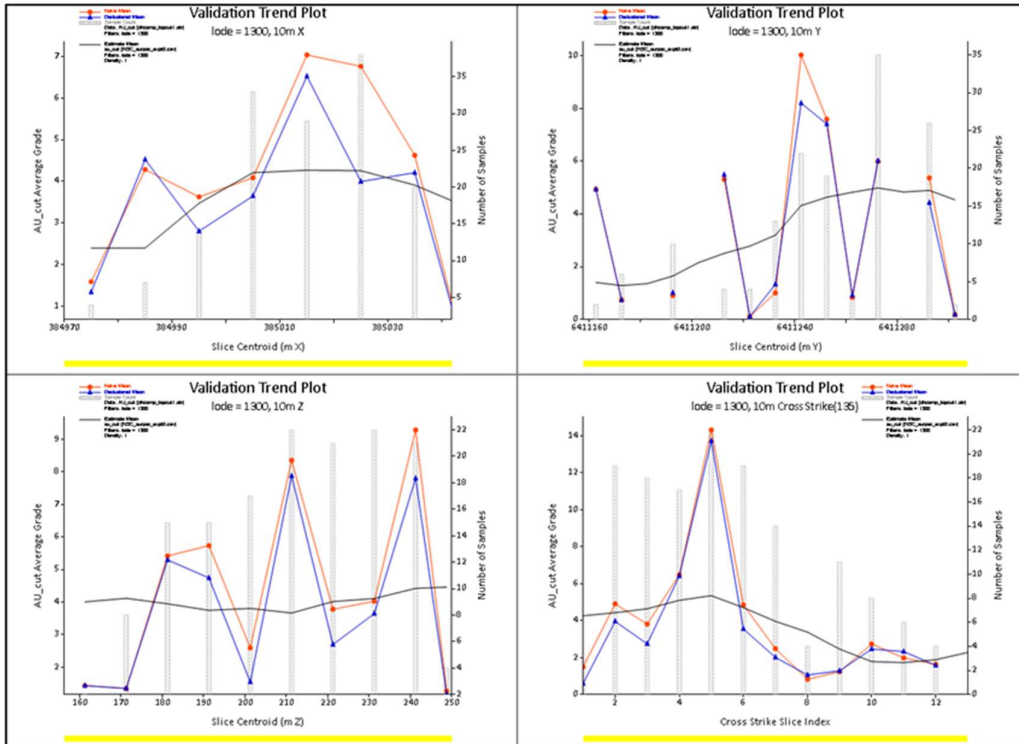

Figure 14-89 North Scotia block swath plot validation for Domain NSC-13



14.4.6.6 Abbotshall Resource Estimation Details

14.4.6.6.1 Geological Model and Mineralization Domains

Abbotshall is a structurally controlled mesothermal gold deposit. The current resource is hosted within a sequence of silicified, brecciated dacitic porphyry. A total of 12 mineralised lodes were constructed (Figure 14-90). All modelling and estimation work was undertaken by Westgold. A lower cut-off grade of 0.5 g/t Au was selected to define the mineralisation in the current estimate. The resource was previously reported with a cut-off grade of 0.7 g/t without the constraint of an RPEEE shell. The 2023 updated reporting has been conducted within the constraint of an RPEEE shell, and the reporting cut-off grade is 0.4 g/t.

Figure 14-90 Abbotshall – oblique view of mineralised lodes (dipping west) and updated RPEEE shell with drill holes, looking northeast

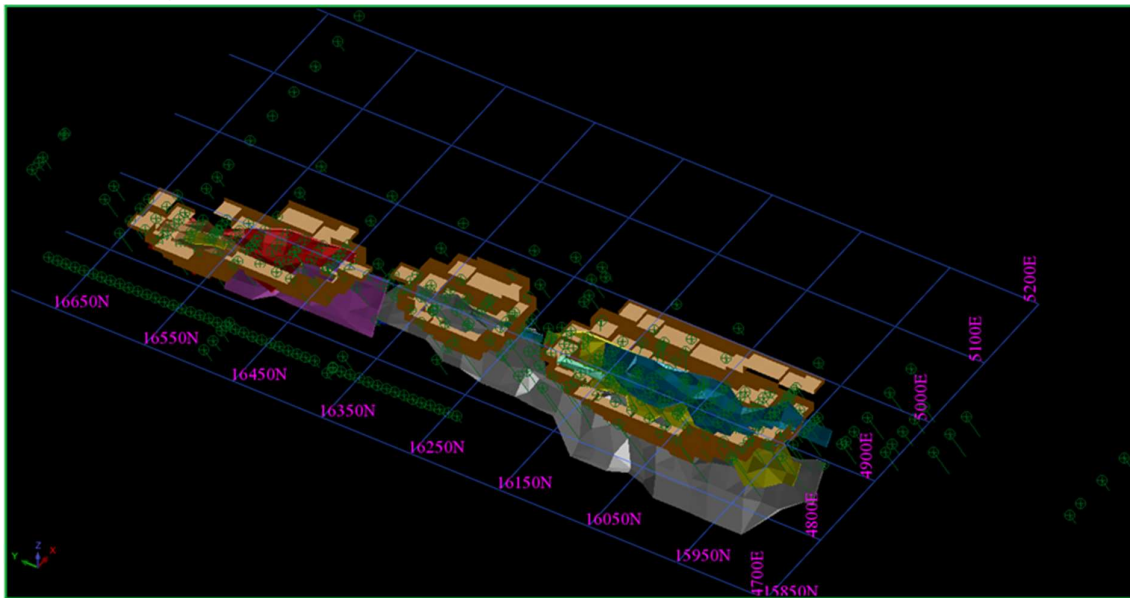

14.4.6.6.2 Data Conditioning

To reflect the majority downhole sample length in the database, 1 m composites were generated. Only Domains 1009 (4 samples @ 16 g/t) and 1015 (1 sample @ 16 g/t) were subject to a grade cap. The overall CV is quite low (average 1.3), which does not necessarily require capping. The capping is more for constraining the influence of individual high-grade samples than adjusting reducing overall grade variability (Table 14-91).

Table 14-91 Abbotshall top-cuts

Lode	Samples	Uncut data			Cut data				Diff%	
		Maximum	Mean	CV	Top-cut	No. Cut	Cut Mean	Cut CV	Mean	CV
1009	335	27.8	2.542	1.39	16	4	2.453	1.24	0.847	0.218
1015	145	22.5	2.135	1.245	16	1	2.091	1.124	2.091	1.124

14.4.6.6.3 Variography

A total of 13 domains in Abbotshall area were estimated using ordinary kriging (OK). An example of the gold grade variogram for Lode 1009 is presented in Figure 14-91, which depicts the downhole variogram (top left) and the directional variograms for the principal direction (a shallow dip to the south), the intermediate direction (a steep dip to the north) and the minor direction (a shallow dip to the west). The nugget variances are moderate to low, at 21% of the sill. Overall, nuggets vary between 10% and 36% of the sill. Maximum ranges vary between 35 m and 95 m. The variogram parameters of three example lodes are summarised in Table 14-92.

Figure 14-91 Abbotshall – example of variography (Lode 1009)

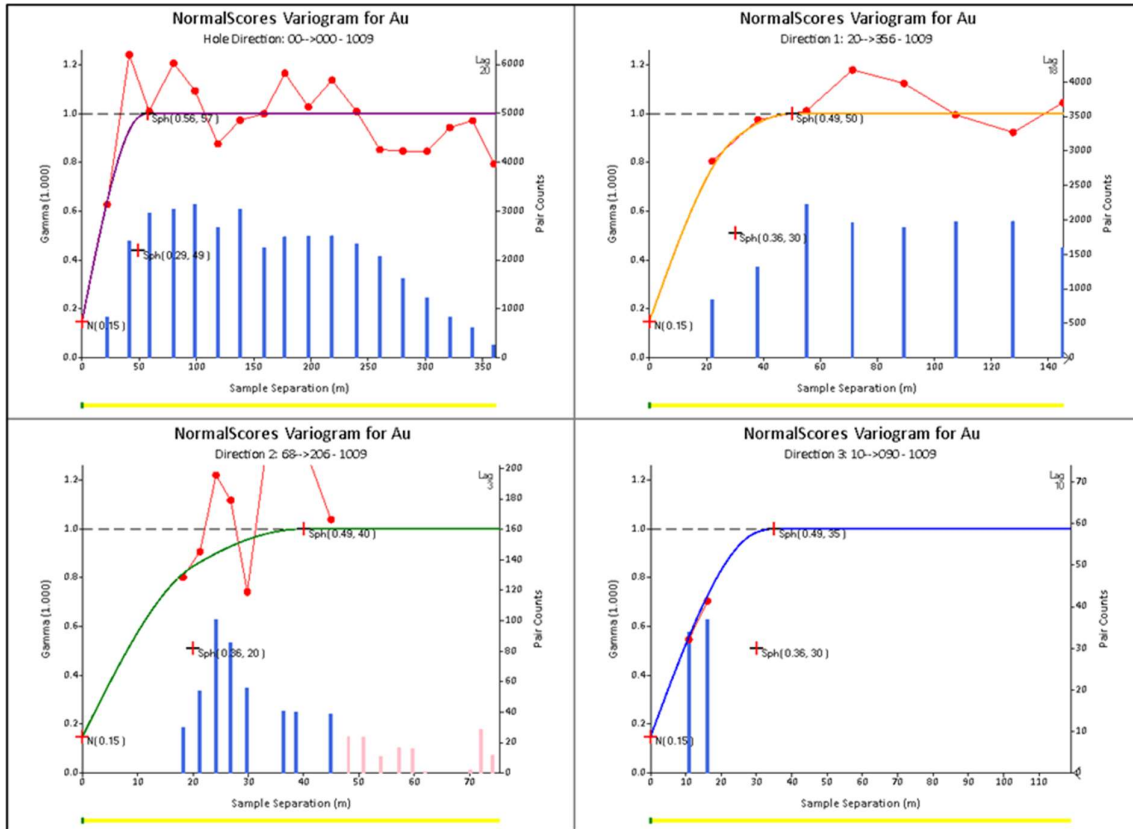

Table 14-92 Abbotshall variogram parameters for selected domains

Domain	No Structures	Nugget	Bearing	Plunge	Dip	Sill 1	Range 1	Range 2	Range 3	Sill 2	Range 1	Range 2	Range 3
1002	2	0.22	0.00	0.00	70.00	0.37	15.0	5.0	2.0	0.41	45.0	10.0	3.0
1009	2	0.21	356.38	19.68	-79.4	0.44	30.0	20.0	30.0	0.35	50.0	33.3	35.0
1014	2	0.21	356.38	19.68	-79.4	0.44	30.0	20.0	30.0	0.35	50.0	33.3	35.0

14.4.6.6.4 Grade Estimation

The most recent grade estimation at Abbotshall, reviewed by the Qualified Person and reported herein, was carried out on a local grid. The block model and extents are detailed in Table 14-93.

In general, three search ellipsoids were used to estimate gold grades in each domain. The initial search ellipsoid was set to the size of the variogram ranges in each of the principal directions and used between 4 and 25 samples for the gold domains. The second search featured an expanded search ellipsoid (generally 100% larger) and a reduced number of samples (2 to 20). A maximum of three or four samples per hole was used. For the 12 domains, over 82% of the blocks were estimated in the first search.

Densities for Abbotshall were assumed and taken from a lithologically similar deposit (Surprise at Meekatharra, another Westgold mine). Bulk density values were assigned to the geological model on the basis of weathering conditions and lithology. Oxide densities varied between 1.8 t/m³ (mafic) to 1.9 t/m³ (porphyry); transitional/partially oxidised densities varied between

2.4 t/m³ (mafic) to 2.5 t/m³ (porphyry); all densities in the transported/soil were set to 1.4 t/m³, and 2.65 t/m³ was used for all densities in the fresh material, irrespective of lithology.

The density values assigned to the model are shown in Table 14-93.

Table 14-93 Abbotshall – block model origin and extents

Axis	Min	Max	Number of blocks	Parent	Sub-block
Y	15800	16800	100	10	1.25
X	4800	5200	40	10	1.25
Z	300	550	100	2.5	1.25

14.4.6.6.5 Model Validation

Optiro completed a block model validation in 2020. There has been no change to the model for 2023, thus the previous discussion relating to model validation is reproduced below, using the US\$1,600 pit shell.

The block model was visually validated against the drill holes within the RPEEE shell (see example in Figure 14-92 and Figure 14-93). In addition to the visual validation, numerical validation was carried out, both at the whole-of-domain level (comparing average capped and composited sample grades with volume-weighted model grades, Table 14-94) and via swath or profile plots (Figure 14-94). The swath plots compare, for example 30 m slices in north, the average volume weighted model grades versus the capped and de-clustered drill hole grades, and also show the number of samples used in each slice. The swath plots were generated for the easting, northing, elevation and cross-strike dimensions and show that the broad grade trends in the drill hole data are reproduced in the block models, albeit with some smoothing inherent to the estimation approach.

Table 14-94 Abbotshall – selected whole-of-domain validation

Domain	Mean composite capped (g/t Au)	De-clustered composite capped (g/t Au)	Block model estimate (g/t Au)	Estimate vs composite %Diff	Estimate vs de-clustered %Diff
1002	1.67	1.53	1.58	-5.26	3.12
1007	2.36	1.99	2.25	-4.52	12.91
1009	2.45	2.13	2.20	-10.27	3.34

Figure 14-92 Section view of model, drill holes and US\$1,600 RPEEE shell at Abbotshall

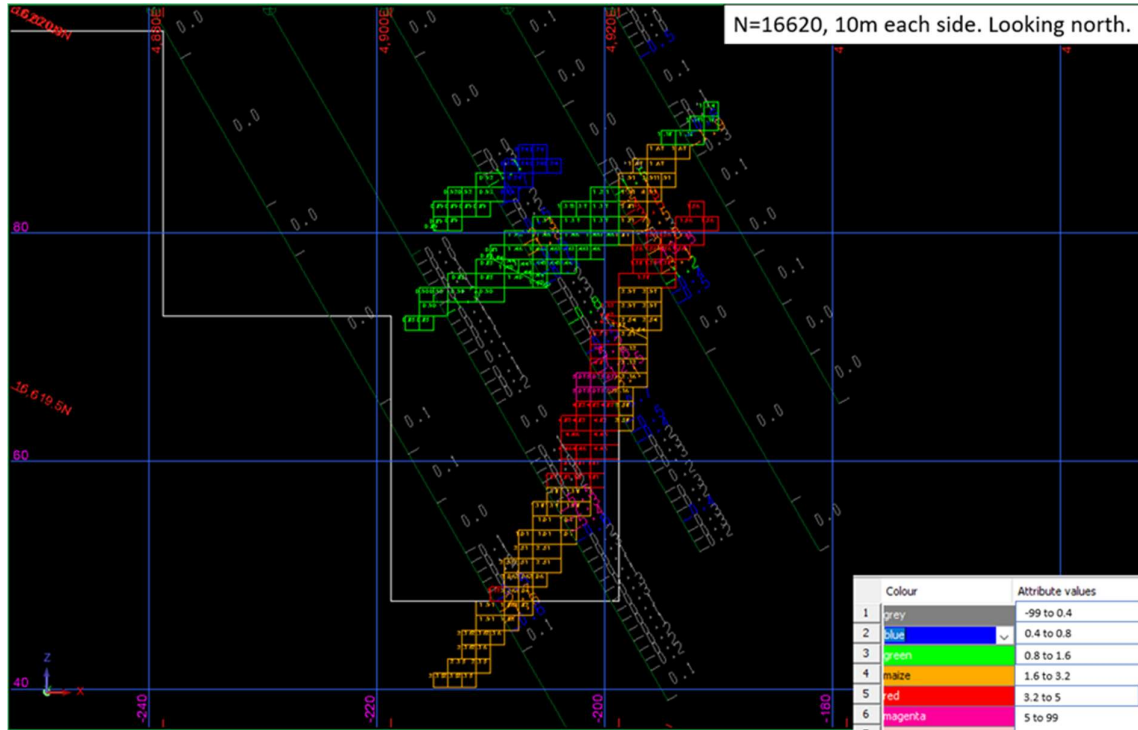

Figure 14-93 Section view of model, drill holes and US\$1,600 RPEEE shell at Abbotshall

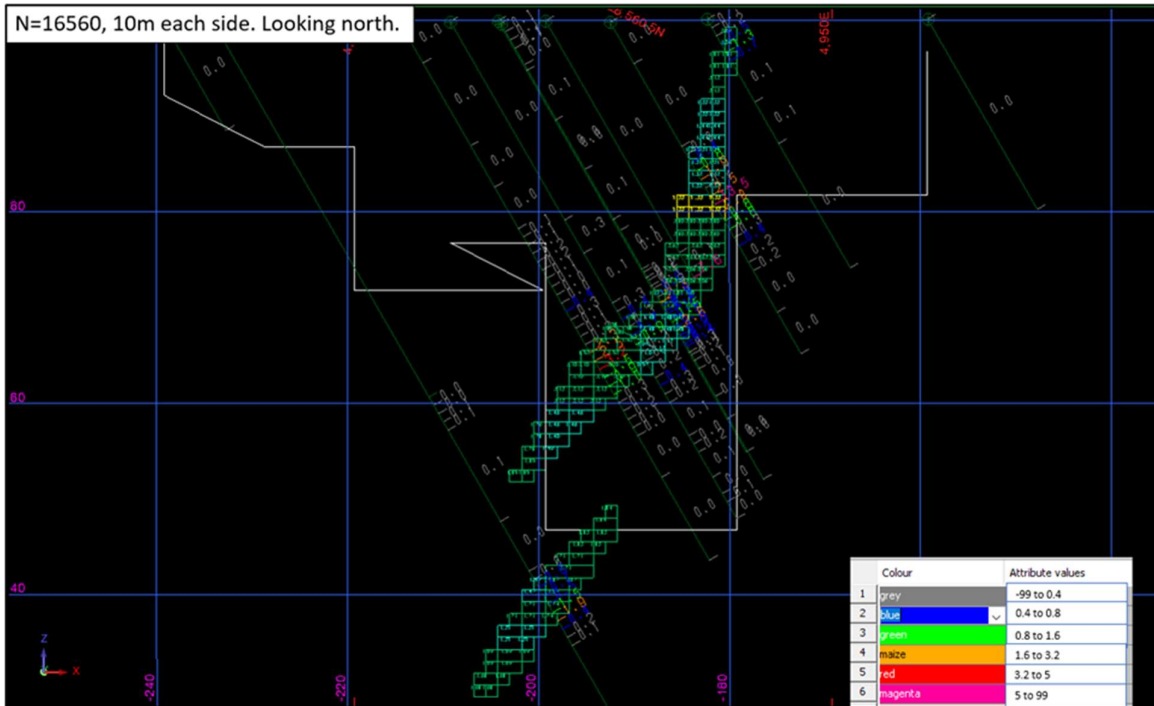
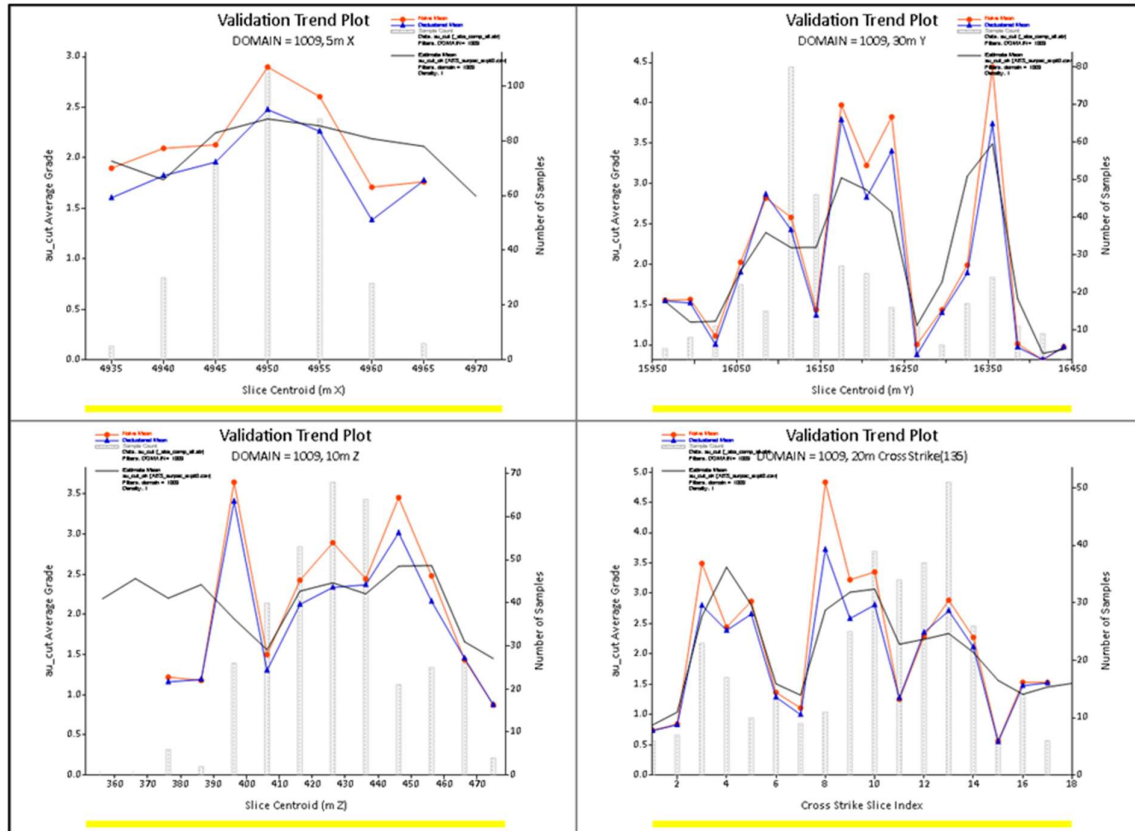

Figure 14-94 Abbotshall – Domain 1009 swath plots



14.4.6.7 Mt Henry Resource Estimation Details

Mt Henry is the only deposit in this group which has been subject to recent mining, by Westgold. The Mt Henry interpretation and estimate were conducted by Westgold. The previously reported resource numbers were validated and reproduced for this declaration. Most of the following information has been summarised from the Westgold 2019 JORC report, apart from the 'model validation' section, which have been independently generated under the guidance of the Qualified Person.

14.4.6.7.1 Geological Model and Mineralization Domains

The geological modelling and definition of resource domains was carried out by Westgold and is pictured in Figure 14-95. The deposit is essentially strata-hosted within a sheared Banded Iron Formation (BIF). The shear is generally contiguous along the upper contact of the BIF and an overlying mafic unit. The mineralisation wireframes were modelled above a gold lower grade cut-off of 0.7 g/t. The Mt Henry deposit was mined by conventional open pit mining methods, using excavators and trucks. Mineralisation wireframes were constructed based on minimum thickness of 2 m downhole in order to replicate the smallest possible mining selectivity.

Figure 14-95 Mt Henry – overview of mineralised domains looking southeast – grid squares are 100 m

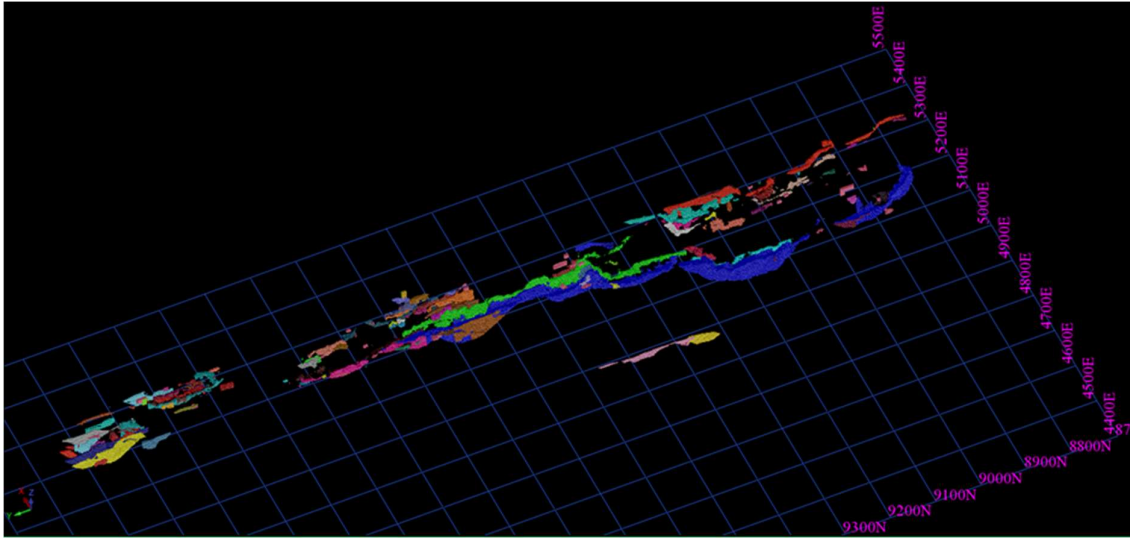

14.4.6.7.2 Data Conditioning

Exploratory statistical analysis was carried out and 90% of the sampling was conducted on less than or equal to 1 m intervals for the total dataset. Approximately, 10% of the intervals are greater than 1 m and a composite length of 1 m was selected for all estimation domains. The coefficients of variation (CV) are generally low and do not necessarily require reduction through capping. Only the domains with high CV values had caps applied in order to restrict the influence of individual samples. For example, the maximum value in Domain 1115 is 69.4 g/t and the mean grade is 2.2 g/t with CV of 1.5. With the cap of 25 g/t, mean value decreases to 2.15 g/t with CV of 1.27.

14.4.6.7.3 Variography

Five separate variogram models were created. For the lodes that were poorly informed, variogram and search parameters were borrowed from statistically similar ones. An example of the gold grade variogram for Lode 1101 is presented in Figure 14-96, which depicts the downhole variogram (top left) and the directional variograms for the principal direction (a shallow dip to the north), the intermediate direction (a steep dip to the southwest) and the minor direction (a shallow dip to the east). The nugget variances are moderate at 42% of the sill, before transformation back to real world variance.

Figure 14-96 Mt Henry – example of modelled variograms for Lode 1101

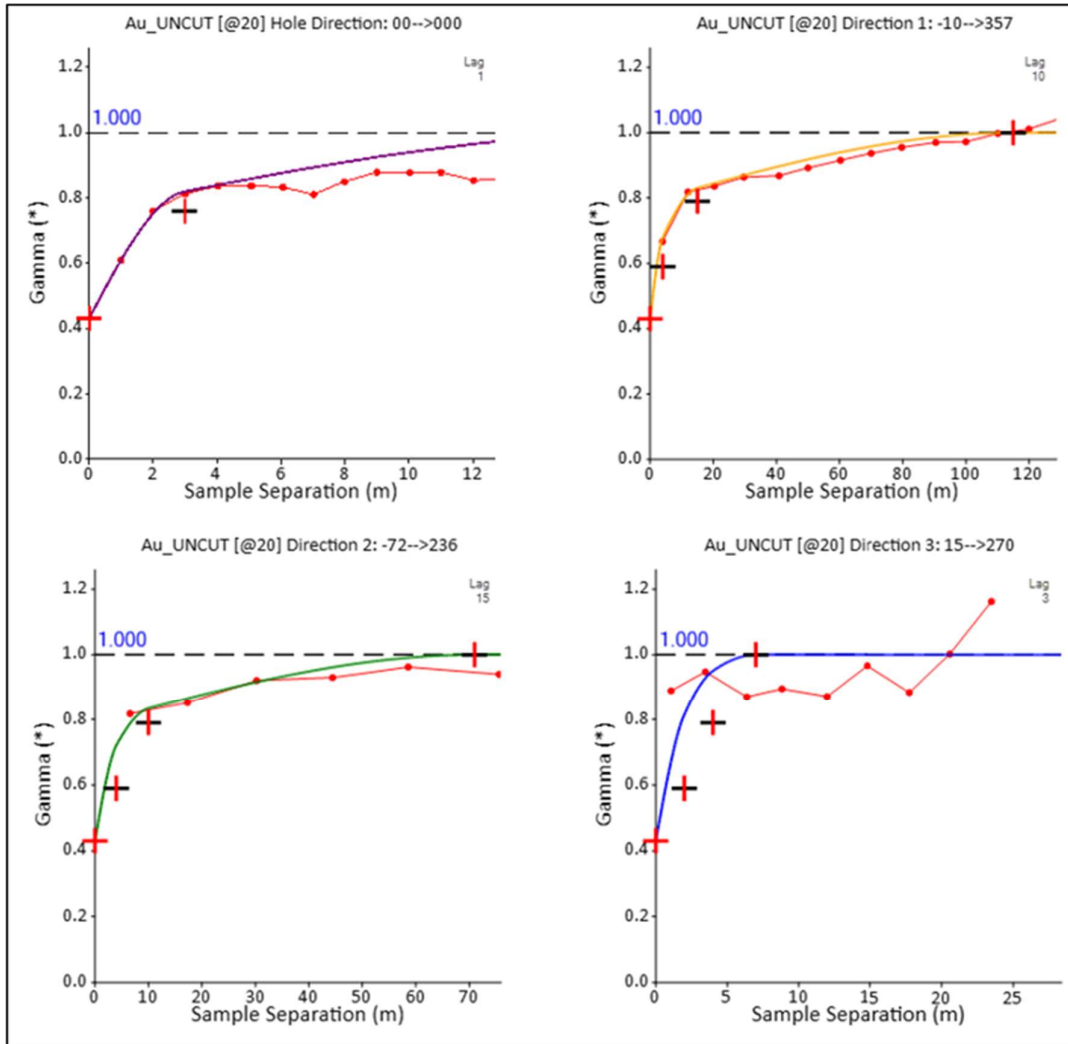

14.4.6.7.4 Grade Estimation

The Mt Henry Mineral Resource has been estimated on a local grid, which is rotated +1.079° from MGA94 zone 51. Ordinary kriging was applied to all lodes. All estimation boundaries were treated as hard boundaries. The block model extents (local coordinates) are shown in Table 14-95.

Table 14-95 Mt Henry – block model extents (local grid) and block size

	Minimum Coordinates	Maximum Coordinates	User block size	Min. block size	Number of blocks
Y	8575	10905	10	2.5	233
X	4575	5225	5	1.25	130
Z	10	400	10	1.25	39

Kriging neighbourhood analysis was used to optimise the estimation parameters, specifically the size of the search ellipsoid, the minimum and maximum number of samples required for estimation, the maximum number of drill holes and the maximum samples per drill hole used to

estimate a block. In general, three search ellipsoids were used to estimate gold grades in each domain. The initial search ellipsoid was set to the size of the variogram ranges in each of the principal directions and used between 12 and 24 samples for the main gold domains. The second search featured an expanded search ellipsoid (generally 50% larger) and a reduced number of samples (4 to 16).

Bulk density assignment for the Mt Henry resource was generated by grouping the 2,501 recorded measurements by rock type to provide an average SG for each of the main lithological rock types. The assay table in the database was tagged with either the measured density or with an average value based on rock type grouped average. The density value was then extracted along with the gold grade in the 1 m composite file. The densities were estimated using the variogram models and search parameters for the various domains.

14.4.6.7.5 Model Validation

Optiro completed a block model validation in 2020 and visually validated the model against the drill holes with the pit surface and RPEEE shell (see examples in Figure 14-97 and Figure 14-98). No consistent bias was detected. The extrapolation was constrained by the US\$1,600/oz RPEEE shell. There has been no change to the model for 2023, thus the previous discussion relating to model validation is reproduced below, using the US\$1,600 pit shells.

Figure 14-97 Visual validation of Mt Henry block model against drilling (9,228.6 mN), showing existing mining shell and RPEEE shell

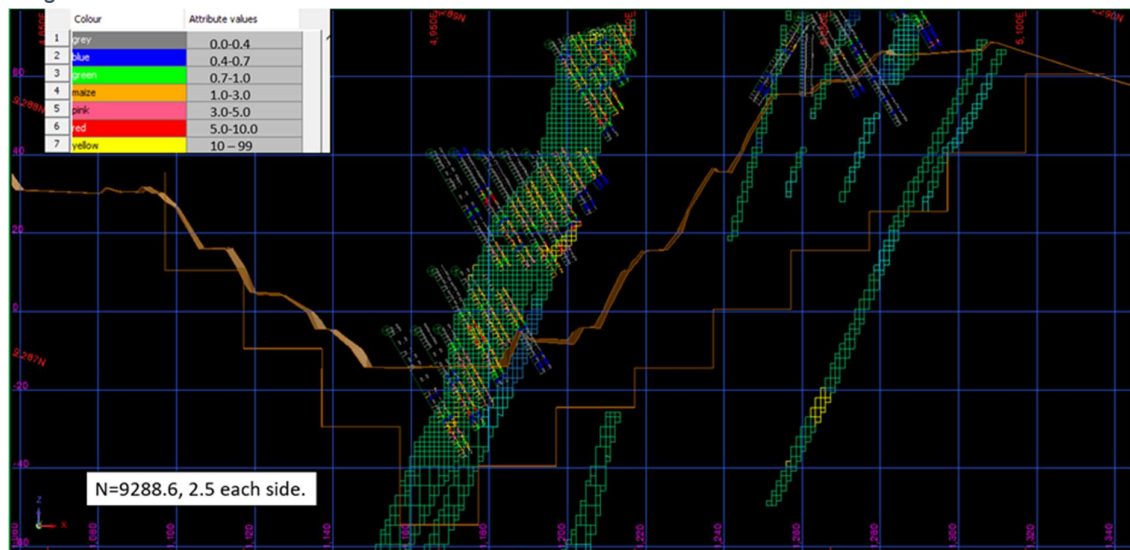
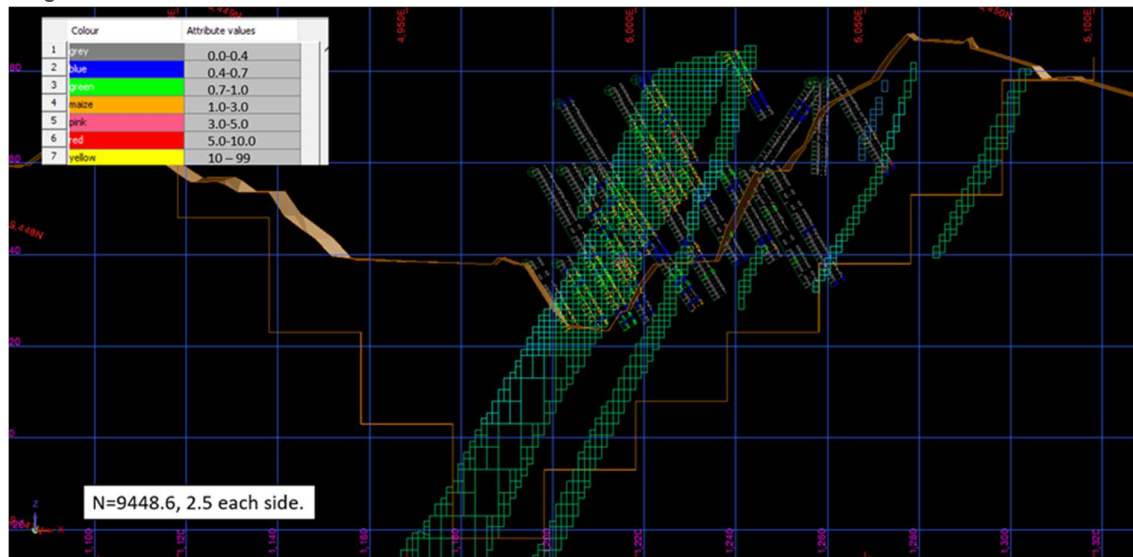

Figure 14-98 Visual validation of Mt Henry block model against drilling (9,448.6 mN), showing existing mining shell and RPEEE shell



14.4.6.7.6 Classification and Reporting – All Deposits

Classification of Abbotshall and Mt Henry was conducted by Westgold in accordance with the JORC Code 2012 guidelines. The Selene and North Scotia 2020 updated Mineral Resource was classified by Snowden Optiro in accordance with the JORC Code 2012 guidelines. A reconciliation of this reporting and the CIM Definition Standards (2014) by the Qualified Person shows no material differences.

The classification was based upon a number of criteria, including the quality of the input data, the support for density values, the thickness and continuity of the mineralisation, the geological confidence in the mineralisation, the estimation parameters used and the quality of the estimation, as measured by a number of parameters, such as the kriging efficiency and the slope of regression. For example, in the Selene area, a broad shape denoting the Measured Mineral Resource was delineated on a series of sections, wireframed, and used to flag the block model with the category (Figure 14-99, left). Similarly, shapes were interpreted to define the limits of the Indicated and Inferred Mineral Resource (Figure 14-99, middle and right). The Selene model was initially flagged with an initial 'confidence' flag (1 corresponds to high/potential Measured, 2 for moderate/potential Indicated, 3 for low/potential Inferred, 4 for minor/potential unclassified), then modified within the constraint of the RPEEE pit shells to the CIM categories.

Figure 14-99 Selene main, hangingwall and footwall (left to right) block model coloured on resource confidence with classification strings

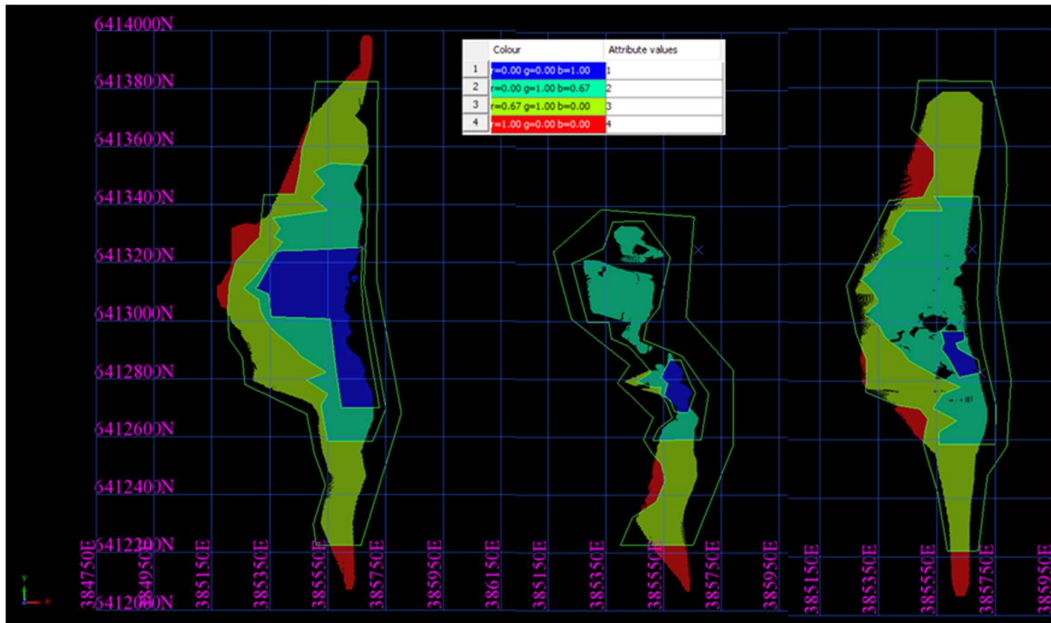
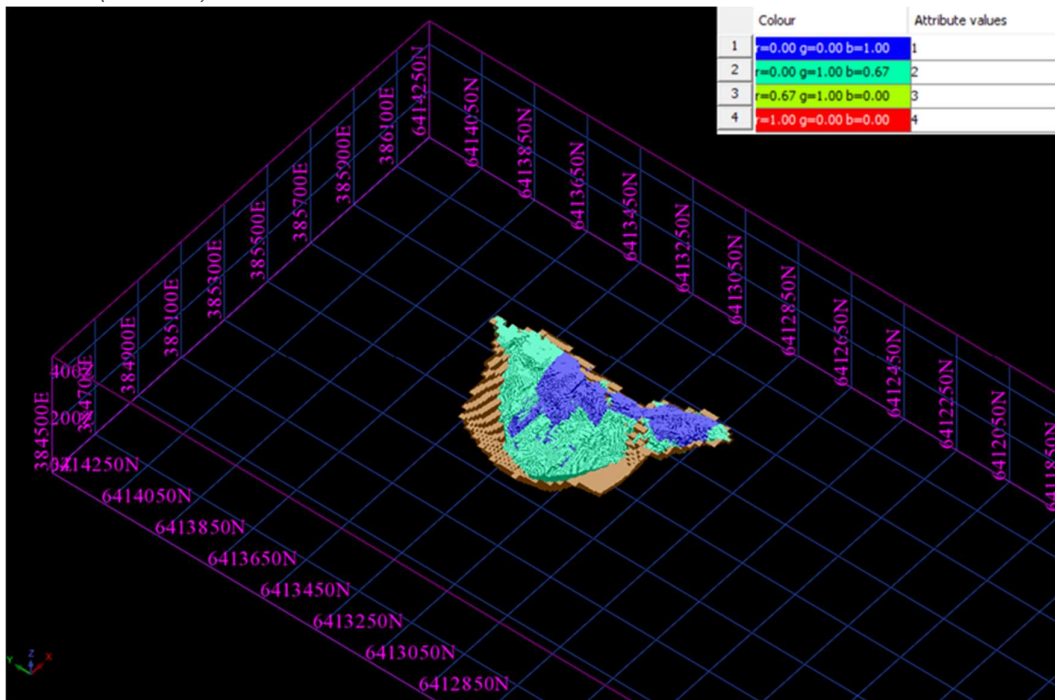

Figure 14-100 Selene block model, coloured by resource category (1=Measured, 2=Indicated), within RPEEE shell (in brown)



14.5 STOCKPILES

Stockpiles generated from the mining of historical and active HGO open pits, are estimated as Measured and Indicated Mineral Resources using the cost assumptions for HGO at the time the stockpile material was dumped (Table 14-96). The estimates use data from grade control protocols during mining with the cut-off based on revenue and costs at the time of production. The grade control evaluation uses a combination of RC sampling to provide gold assays, dig-blocks defined by in-pit mapping of key structures and lithologies and grade interpolation.

Table 14-96 Stockpile Mineral Resource – HGO – as at September 30, 2023

Sep. 2023 Mineral Resource	Measured			Indicated			Measured & Indicated			Inferred		
	kt	g/t	koz	kt	g/t	koz	kt	g/t	koz	kt	g/t	koz
HGO Stockpiles	745	0.6	15	1,135	0.7	27	1,880	0.7	42	-	-	-

- 1) Mineral Resources that are not Mineral Reserves do not have demonstrated economic viability. There is no certainty that Mineral Resources that are not Mineral Reserves do not have demonstrated economic viability. There is no certainty that all or any part of the Mineral Resources estimated will be converted into Mineral Reserves.
- 2) The Measured and Indicated Mineral Resources are inclusive of those Mineral Resources modified to produce Mineral Reserves.
- 3) The Gold Mineral Resources are estimated using a long-term gold price of US\$1,700/oz with a USD:AUD exchange rate of 0.70.
- 4) Classification is according to JORC Code and CIM Definition Standards Mineral Resource classification categories.
- 5) Mineral Resource tonnage and contained metal have been rounded to reflect the accuracy of the estimate, and numbers may not add due to rounding.
- 6) Gold Mineral Resource estimates were prepared under the supervision of Qualified Person S. Devlin, FAusIMM (Chief Geological Officer, Karora Resources).

15 MINERAL RESERVE ESTIMATES

15.1 INTRODUCTION

The Gold Mineral Reserve estimates have been prepared using accepted industry practice and in accordance with NI 43-101 reporting standards, by Mr. Glenn Reitsema, MAusIMM under the supervision of Mr. Peter Ganza, MAusIMM (CP). Both are employees of Karora Resources. Mr. Ganza MAusIMM (CP) accepts responsibility as Qualified Person for the Mineral Reserve estimates.

Higginsville is an operating gold mine, allowing current design criteria, mining methods and actual costs to form the basis for mine design, scheduling and economic evaluation used in this estimation process. As an operating mine, costs, mining methods and metallurgical factors are well understood, providing confidence in their application as part of the Mineral Reserve estimation. All major infrastructure and permitting is also in place. The economics of the Mineral Reserve estimate could be materially affected by a significant change to commodity price.

Gold Mineral Reserves at Higginsville are split into two separate geological regions, Higginsville Central and Higginsville Greater. The Mineral Reserve estimate effective September 30, 2023 is summarized in Table 15-1.

Table 15-1 Higginsville Gold Mineral Reserves at September 30, 2023

Sep. 2023 Mineral Reserve	Proven			Probable			Proven & Probable		
	kt	g/t	koz	kt	g/t	koz	kt	g/t	koz
HGO Central	176	2.0	12	702	2.8	63	878	2.6	75
HGO Greater	7,497	1.3	320	4,925	1.8	285	12,422	1.5	605
Stockpiles	405	0.8	10	569	0.8	16	973	0.8	26
Total	8,078	1.3	342	6,196	1.8	363	14,273	1.5	705

- 1) The Mineral Reserve is reported at varying cut-off grades per deposit ranging from 1.6 g/t to 2.0 g/t for Underground Mineral Reserves to 0.8 g/t to 1.0 g/t for Open Pit Mineral Reserves.
- 2) Key assumptions used in the economic evaluation include:
 - a. A metal price of US\$1,500/oz gold and an exchange rate of 0.70 USD:AUD.
 - b. Metallurgical recovery varies by deposit.
 - c. The cut-off grade takes into account operating, mining, processing/haulage and G&A costs, excluding capital.
- 3) The Mineral Reserve is depleted for all mining to September 30, 2023.
- 4) The tonnes and grades are stated to a number of significant digits reflecting the confidence of the estimate. Since each number is rounded individually, the table may show apparent inconsistencies between the sum of rounded components and the corresponding rounded total.
- 5) The Mineral Reserve tonnages and grades are estimated and reported as delivered to plant (the point where material is delivered to the mill) and is therefore inclusive of ore loss and dilution.
- 6) CIM Definition Standards (2014) were followed in the calculation of Mineral Reserves.
- 7) Gold Mineral Reserve estimates were prepared under the supervision of Qualified Person P. Ganza, MAusIMM (CP).

15.2 HIGGINSVILLE CENTRAL

Higginsville Central Mineral Reserves comprise the deposits of Trident, Mitchell and Pioneer.

15.2.1 Trident Underground

The underground Trident Deposit has three distinct mineralised zones called Western Zone, Eastern Zone and Athena Lodes. Access is gained from the previously mined Poseidon South open pit and underground workings.

Trident features narrow, mineralised zones. airleg room and pillar stoping is proposed and planned for these zones, as a well-known and practiced mining method in various underground gold mines of Western Australia. The Trident Mineral Reserves were optimised, designed and scheduled by mineral zone and mining method.

Trident has a number of developed areas and some remnant mining potential. These developed areas will require rehabilitation and other areas will require access and ore drive development. The development to ore tonnes ratio remains attractive for Trident. The Trident Mineral Reserve was previously stated in Karora's 2021 NI 43-101 Report for HGO (Karora, 2021a), with Anton von Wielligh of ABGM Pty Ltd as the QP. Having reviewed the previous data and updated it with up to date modifying factors (costs and gold price), Mr. Ganza MAusIMM (CP) accepts responsibility as Qualified Person for the Trident Mineral Reserve estimates.

15.2.1.1 Mineral Reserve Estimation Process

Trident is planned to operate as an underground gold mine allowing current design criteria, mining methods and actual costs to form the basis for mine design, scheduling and economic evaluation used in this estimation process. As an historic operating underground mine, costs, mining methods and metallurgical factors are well understood, providing confidence in their application as part of the Mineral Reserve estimation process. Although some additional surface infrastructure will be required, the key major infrastructure and permitting is in place with access to a well-established decline portal. The economics of the Mineral Reserve estimate could be materially affected by a significant change to commodity price.

Designs previously completed by ABGM were loaded into Deswik software and verified against current as-builts and the resource model. These designs were scheduled in Deswik and interrogated against the resource model *trident_mar17_trim.dm*. Economics of levels were evaluated within Deswik Sched, using a Pseudoflow algorithm and assumed costs for each mining activity, to exclude any areas that were uneconomic.

Key assumptions include:

- Development dilution of 10% additional tonnes at 0 g/t;
- Stope dilution is included in the designed stope shapes of the longhole open stoping (LHOS) and airleg mining methods and therefore dilution carries the evaluated grade from the Mineral Resource Model (provided it is within the Measured or Indicated Mineral Resource categories); and
- Stope recovery factor of 90% for LHOS stopes. Stope recovery factor of 95% for airleg stopes.

The resulting Mineral Reserve estimate as at September 30, 2023 is shown in Table 15-2.

Table 15-2 Trident Gold Mineral Reserves at September 30, 2023

Sep. 2023 Mineral Reserve	Proven			Probable			Proven & Probable		
	kt	g/t	koz	kt	g/t	koz	kt	g/t	koz
Trident	132	2.2	9	307	3.5	34	439	3.1	44

- 1) The Mineral Reserve is reported at a 0.5 g/t cut-off grade for development and a 1.5 g/t cut-off grade for stopes.
- 2) Key assumptions used in the economic evaluation include:
 - a. A metal price of US\$1,500/oz gold and an exchange rate of 0.70 USD:AUD.
 - b. Metallurgical recovery of 95%.
 - c. The cut-off grade takes into account operating, mining, processing/haulage and G&A costs, excluding capital.
- 3) The Mineral Reserve is depleted for all mining to September 30, 2023.
- 4) The tonnes and grades are stated to a number of significant digits reflecting the confidence of the estimate. Since each number is rounded individually, the table may show apparent inconsistencies between the sum of rounded components and the corresponding rounded total.
- 5) The Mineral Reserve tonnages and grades are estimated and reported as delivered to plant (the point where material is delivered to the mill) and is therefore inclusive of ore loss and dilution.
- 6) CIM Definition Standards (2014) were followed in the calculation of Mineral Reserves.
- 7) Gold Mineral Reserve estimates were prepared under the supervision of Qualified Person P. Ganza, MAusIMM (CP).

15.2.1.2 Stope Design Parameters

The following stope design parameters were applied within the mine design:

- Minimum footwall dip angles were set at 42°;
- Minimum mining widths (excluding dilution) of 4.5 m and 1.7 m for the LHOS and airleg stoping methods, respectively;
- Dilution of 1 m on the footwall and hangingwall of each stope shape (total of 2 m of dilution) applied as part of the stope optimisation process for the LHOS and 10% (0.2 m) additional overbreak for the airleg stoping. The dilution is evaluated with the Mineral Resource model; therefore, dilution carries the evaluated grade from the Mineral Resource Model; and
- Natural low-grade rock pillars have been included in the mine design per the economic stope shapes developed. Proximity to old mined out areas were also considered. An additional mining recovery factor of 90% has been applied to account for ore extraction and ore losses and bogging recovery losses.

15.2.1.3 Cut-Off Grade Derivation

Two Mineable Shape Optimiser® (MSO) optimisations were completed to develop stope shapes, the first used a gold grade cut-off (diluted cut-off grade) of 2.2 g/t. The secondary optimisation/shape definition used a cut-off grade of 1.5 g/t. Stopes where both shapes provided the same stoping areas used the higher ounces stope formed (of the two). The key optimisation and design focus were to increase ounces (as there would be recommencement work and cost) and defining the best ounce profile was deemed key. An ore development cut-off grade of 0.5 g/t was applied which covers the processing cost, as mining and haulage of this material is a sunk cost required for access for stoping. The cut-off grade inputs and calculations are shown in Table 15-3 and Table 15-4.

The Trident mine design and schedule is extremely sensitive to revenue factors, so changes to recovery or gold price may impact economic areas as designed for this Mineral Reserve.

Table 15-3 Trident Underground Mineral Reserves – net gold price calculation

Parameter	Unit	Value
Gold Price	US\$/oz	1,500
Exchange Rate	USD:AUD	0.7
State Royalty	%	2.5
Third Party Royalty	%	4.0
Metallurgical Recovery	%	95
Net Price (after recovery)	A\$/oz	1,903
Net Price (after recovery)	A\$/g	61.2

Table 15-4 Trident cut-off grade calculation inputs

Operating Cost	Unit	Operating Cost (inc Development)	Marginal Stopping Costs (no Development)	Development Cut-off	Total Mining Costs Including Capital Development
Mining Direct Operating Costs	A\$/t	72.5	25.9		106.2
Mining Maintenance Costs	A\$/t	8.7	8.7		8.7
Mine Management & Technical Services	A\$/t	12.6	12.6		12.6
Site G&A	A\$/t	7.8	7.8		7.8
Haulage Cost	A\$/t	0.0	0.0	0.0	0.0
Processing Cost	A\$/t	35.2	35.2	35.2	35.2
Total Cost	A\$/t	136.8	90.2	35.2	170.5
Stope Cut-off Grade	g/t	2.2			
Incremental Stope Cut-off Grade	g/t		1.5		
Incremental Development Cut-off Grade	g/t			0.6	
Fully Costed Cut-off Grade	g/t				2.8

15.2.2 Open Pits

This section covers the calculation of the open pit Mineral Reserves for the Mitchell and Pioneer open pits.

15.2.2.1 Mineral Reserves Estimation Process

A process has been followed to convert the Mineral Resources to Mineral Reserves which is underpinned by design, schedule and economic evaluation. This process is described below and in the following sections.

- The following Mineral Resource models as described in Section 14 were used to complete pit optimisation, design and schedule for the Mitchell and Pioneer Mineral Reserves.
 - Mitchell *mitchell_20180317.dm*
 - Pioneer *pioneer_bm_20231020_eng.mdl*
- Mining ore loss and dilution were estimated by re-blocking each resource model to a 2.5 m x 2.5 m x 5 m size which represents the minimum selective mining unit (SMU) size of the planned open pit fleet.
- Open pit optimisations were run by Karora on the diluted models described above using Deswik software Pseudoflow optimisation algorithm. Modifying factors including mining costs, processing costs, selling costs, metallurgical recoveries and gold price were applied

within the software and optimal shells were then selected as the basis for subsequent designs.

- Mine designs were then completed for the three mining areas.
 - Mitchell – a cutback on the existing pit; and
 - Pioneer – a northern and southern pit.
- Designs were scheduled in Deswik, with tonnes and grade interrogated against the original resource model, with global averages for dilution (10%) and mining recovery (95%) applied.
- A production schedule was then developed for each pit separately with mining productivity based on a Caterpillar 6020 excavator matched to Caterpillar 777 haul trucks.
- The resulting mining schedule was evaluated by re-applying the modifying factors to the mining schedule physicals to ensure the designs and schedule were economically viable.

The Mineral Reserve estimate effective September 30, 2023 is summarized in Table 15-5.

Table 15-5 Mitchell and Pioneer Gold Mineral Reserves at September 30, 2023

Sep. 2023 Mineral Reserve	Proven			Probable			Proven & Probable		
	kt	g/t	koz	kt	g/t	koz	kt	g/t	koz
Mitchell	0	0	0	205	2.3	15	205	2.3	15
Pioneer	44	1.6	2	189	2.2	14	233	2.1	16
Total	44	1.6	2	395	2.3	29	438	2.2	31

- 1) The Mineral Reserve is reported at a 0.8 g/t cut-off grade for Mitchell and Pioneer.
- 2) Key assumptions used in the economic evaluation include:
 - a. A metal price of US\$1,500/oz gold and an exchange rate of 0.70 USD:AUD.
 - b. Metallurgical recovery varies by deposit.
 - c. The cut-off grade takes into account operating, mining, processing/haulage and G&A costs, excluding capital.
- 3) The Mineral Reserve is depleted for all mining to September 30, 2023.
- 4) The tonnes and grades are stated to a number of significant digits reflecting the confidence of the estimate. Since each number is rounded individually, the table may show apparent inconsistencies between the sum of rounded components and the corresponding rounded total.
- 5) The Mineral Reserve tonnages and grades are estimated and reported as delivered to plant (the point where material is delivered to the mill) and is therefore inclusive of ore loss and dilution.
- 6) CIM Definition Standards (2014) were followed in the calculation of Mineral Reserves.
- 7) Gold Mineral Reserve estimates were prepared under the supervision of Qualified Person P. Ganza, MAusIMM (CP).

15.2.2.2 Cut-off Grade Derivation

The ore cost is a combination of the processing cost, any mining specific Mineral Reserve costs (e.g. rehandle, grade control etc.) and the road haulage to the Higgsville Mill. Summarised processing costs include an allowance for sustaining capital and tails dam construction on a dollar per tonne basis.

The net price calculation is detailed in Table 15-6; the resulting cut-offs used to define the Mineral Reserve are detailed in Table 15-7.

Table 15-6 Mitchell and Pioneer Open Pit Mineral Reserves – net gold price calculation

Parameter	Unit	Mitchell	Pioneer
Gold Price	US\$/oz	1,500	1,500
Exchange Rate	USD:AUD	0.7	0.7
State Royalty	%	2.5	2.5
Third Party Royalty	%	4	4
Third Party Royalty - Mitchell	A\$/oz	32	0
Net Price	A\$/oz	1,971.6	2,003.6
Net Price	A\$/g	63.4	64.4

Table 15-7 Mitchell and Pioneer Open Pit Mineral Reserves – cut-off grade calculation

Parameter	Material	Unit	Mitchell	Pioneer	Source
Haulage Cost	All	\$/t	3.71	5.19	Actual Costs
Processing Costs (inc. Sustaining Capital)	All	\$/t	35.15	35.15	Site Actuals and Forecast
Site G&A	All	\$/t	7.8	7.8	Site Forecast
Processing Recovery	Oxide	%	88	92	Metallurgical Testwork
	Trans	%	88	92	Metallurgical Testwork
	Fresh	%	N/A ⁽¹⁾	92	Metallurgical Testwork
Cut-off Grade	Oxide	g/t	0.8	0.8	
	Trans	g/t	0.8	0.8	
	Fresh	g/t	N/A	0.8	

1) Mitchell Pit does not include any fresh material.

15.3 HIGGINSVILLE GREATER

Higginsville Greater Mineral Reserves comprise the deposits of Chalice, Spargos, Mt Henry, Musket and the Lake Cowan deposit of Atrides.

15.3.1 Chalice Underground

The Higginsville Greater deposits include the Chalice open pit (depleted) and remnants remaining in the Chalice underground mine.

The Chalice Gold Deposit is situated 22 km west-southwest of the Higginsville mining camp within the southwestern portion of the Archaean Norseman-Wiluna granitoid-greenstone belt, Yilgarn Craton, Western Australia. Access is via the Coolgardie-Esperance Highway.

The terrane immediate to the Chalice Deposit is lightly wooded, essentially flat. Waste dumps are located to the west of the open pit (Figure 15-1) with good access.

The Chalice Mineral Reserve was previously stated in Karora's 2021 NI 43-101 Report for HGO, with Anton von Wielligh of ABGM Pty Ltd as the QP. Having reviewed and verified the previous data and updated it with up to date modifying factors (costs and gold price), Mr. Ganza MAusIMM (CP) accepts responsibility as Qualified Person for the Chalice Mineral Reserve estimates. While updated and verified, it is the opinion of the QP that the Chalice Underground Mineral Reserves have not materially changed.

Figure 15-1 Chalice aerial view showing pit (flooded)



15.3.1.1 Mineral Reserves Estimation Process

Chalice mine is planned as an operating underground gold mine allowing current design criteria, mining methods and actual costs to form the basis for mine design, scheduling and economic evaluation used in this estimation process. As an historic operating underground mine, costs, mining methods and metallurgical factors are well understood, providing confidence in their application as part of the Mineral Reserve estimation process. Chalice will require most of the mining infrastructure to be re-established. The underground is planned to be accessed from inside the Chalice open pit. Rehabilitation of the portal/entrance and the Chalice decline will be

required and was planned and costed as part of the scheduling and cost estimation. The economics of the Mineral Reserve estimate could be materially affected by a significant change to commodity price.

Designs previously completed by ABGM were loaded into Deswik software and verified against current as-builts and the resource model. These designs were scheduled in Deswik and interrogated against the resource model *Chalice_res-Nov14.bmf*. Economics of levels were evaluated within Deswik Sched, using a Pseudoflow algorithm and assumed costs for each mining activity, to exclude any areas that were uneconomic.

Key assumptions include the following:

- Development dilution of 10%;
- Stope dilution included in the designed stope shapes and therefore dilution carries the evaluated grade from the Mineral Resource Model (provided it is within the Measured or Indicated Mineral Resource categories); and
- Stope recovery factor of 90%.

The resulting Mineral Reserve estimate as at September 30, 2023 is shown in Table 15-8.

Table 15-8 Chalice Gold Mineral Reserves at September 30, 2023

Sep. 2023 Mineral Reserve	Proven			Probable			Proven & Probable		
	kt	g/t	koz	kt	g/t	koz	kt	g/t	koz
Chalice	190	2.3	14	586	2.1	40	777	2.1	54

- 1) The Mineral Reserve is reported at a 0.5 g/t cut-off grade for development and a 1.5 g/t cut-off grade for stopes.
- 2) Key assumptions used in the economic evaluation include:
 - a. A metal price of US\$1,500/oz gold and an exchange rate of 0.70 USD:AUD.
 - b. Metallurgical recovery of 94.5%.
 - c. The cut-off grade takes into account operating, mining, processing/haulage and G&A costs, excluding capital.
- 3) The Mineral Reserve is depleted for all mining to September 30, 2023.
- 4) The tonnes and grades are stated to a number of significant digits reflecting the confidence of the estimate. Since each number is rounded individually, the table may show apparent inconsistencies between the sum of rounded components and the corresponding rounded total.
- 5) The Mineral Reserve tonnages and grades are estimated and reported as delivered to plant (the point where material is delivered to the mill) and is therefore inclusive of ore loss and dilution.
- 6) CIM Definition Standards (2014) were followed in the calculation of Mineral Reserves.
- 7) Gold Mineral Reserve estimates were prepared under the supervision of Qualified Person P. Ganza, MAusIMM (CP).

15.3.1.2 Stope Design Parameters

The following stope design parameters were applied within the mine design:

- Minimum footwall dip angles were set at 42°;
- Minimum mining widths (inclusive of planned dilution) of 4.5 m;
- Dilution of 1 m on the footwall and hangingwall of each stope shape (total of 2 m of dilution) applied as part of the stope optimisation process for the LHOS;
- The dilution is evaluated with the Mineral Resource model; therefore, dilution carries the evaluated grade from the Mineral Resource Model (provided it is within the Measured or Indicated Mineral Resource categories); and

- Natural low-grade rock pillars have been included in the mine design per the economic stope shapes developed. Proximity to old mined out areas were also considered. An additional mining recovery factor of 90% has been applied to account for ore extraction and ore losses and bogging recovery losses.

15.3.1.3 Cut-off Grade Derivation

Two MSO optimisations were completed to develop stope shapes, the first used a gold grade cut-off (diluted cut-off grade) of 1.8 g/t. The secondary optimisation/shape definition used a cut-off grade of 1.5 g/t. Stopes where both shapes provided the same stoping areas used the higher ounces stope formed (of the two). The key optimisation and design focus were to increase ounces (as there would be recommencement work and cost) and defining the best ounce profile was deemed key.

The initial stopes were run but then only stopes grading 1.8 g/t Au or more (diluted/modified stope grades) were first designed and then a 1.5 g/t cut-off grade was applied to all underground design areas provided the areas have development and all potential capital costs covered (marginal cut-off grade). An ore development cut-off grade of 0.6 g/t was applied which covers the processing cost, as mining and haulage of this material is a sunk cost required for access for stoping. Cut-off grade inputs and calculations are shown in Table 15-9 and Table 15-10.

The Chalice mine design and schedule is extremely sensitive to revenue factors, so changes to recovery or gold price may impact economic areas as designed for this Mineral Reserve.

Table 15-9 Chalice Underground Mineral Reserves – net gold price calculation

Parameter	Unit	Value
Gold Price	US\$/oz	1,500
Exchange Rate	USD:AUD	0.7
State Royalty	%	2.5
Third Party Royalty	%	4.0
Metallurgical Recovery	%	94
Net Price	A\$/oz	1,883
Net Price	A\$/g	60.5

Table 15-10 Chalice Underground Mineral Reserves – cut-off grade calculation inputs

Operating Cost	Unit	Operating Cost (inc Development)	Marginal Stopping Costs (no Development)	Development Cut-off	Total Mining Costs Including Capital Development
Mining Direct Operating Costs	A\$/t	45.3	29.2		53.0
Mining Maintenance Costs	A\$/t	6.9	6.9		6.9
Mine Management & Technical Services	A\$/t	13.5	13.5		13.5
Site G&A	A\$/t	7.8	7.8		7.8
Haulage Cost	A\$/t	6.1	6.1	6.1	6.1
Processing Cost	A\$/t	35.2	35.2	35.2	35.2
Total Cost	A\$/t	114.8	98.7	41.3	122.4
Stope Cut-off Grade	g/t	1.8			
Incremental Stope Cut-off Grade	g/t		1.5		
Incremental Development Cut-off Grade	g/t			0.6	
Fully Costed Cut-off Grade	g/t				1.9

15.3.2 Spargos Underground

The Spargos underground is planned to be accessed via two portals near the base of the existing Spargos open pit; one portal is the main access and haulage portal and the other is the primary ventilation exhaust and second means of egress portal. A single decline on the east side of the orebody will provide access to the mining levels, which are spaced at 20 m vertical (floor-to-floor). The intended mining method is top-down LHOS with pillars. A conventional medium-sized diesel fleet has been specified in the current mine design. Road trains will haul the ore to the Higgsville Mill via previously constructed private haul road to the nearby Coolgardie-Esperance Highway. Ore will be processed at the Higgsville Mill.

15.3.2.1 Mineral Reserves Estimation Process

The process to convert the Mineral Resources to Mineral Reserves which is underpinned by mine design, schedule and economic evaluation. This process is described in the following points, with further detail provided in subsequent sections.

- A Mineral Resource model was provided *spargos_res_bm_20230512_eng.mdl*
- Stope optimisations were run on these Mineral Resource models, using MSO filtered to a 2.0 g/t cut-off grade. The resulting stope shapes were reviewed for practicality of mining, with impractical mining shapes removed.
- Modifying factors were applied to these stope shapes including dilution and recovery factors based on estimated dilution and recovery performance as detailed in Section 16.2.2.7
- A development design was produced to align with the resulting stope shapes that tied into the existing underground as-builts. The development design follows current site design criteria and a development ore dilution factor of 10% and recovery factor of 100% has been applied.
- Stope shapes were depleted with development drives.
- All stope and development designs (the mine design) were evaluated with Mineral Resource models and any Inferred material within the mine design was set to waste grade (0 g/t Au).
- Mining areas and extraction levels were evaluated using the cost and revenue assumptions applied in the cut-off grade estimation and sub-economic levels were removed from the Mineral Reserve.
- The mine design was scheduled in Deswik mining software to produce a mine plan, using industry standard productivity rates and following the appropriate mining sequence.
- The resulting mining schedule was evaluated in a financial model based on current operation costs to ensure economic viability.

The resulting Mineral Reserve estimate as at September 30, 2023 is shown in Table 15-11.

Table 15-11 Spargos Underground Mineral Reserves at September 30, 2023

Sep-2023 Mineral Reserve	Proven			Probable			Proven & Probable		
	kt	g/t	koz	kt	g/t	koz	kt	g/t	koz
Spargos	0	0	0	437	4.6	64	437	4.6	64

- 1) The Mineral Reserve is reported at a 0.7 g/t cut-off grade for development and a 2.0 g/t cut-off grade for stopes.
- 2) Key assumptions used in the economic evaluation include:
 - a. A metal price of US\$1,500/oz gold and an exchange rate of 0.70 USD:AUD.
 - b. Metallurgical recovery of 90%.
 - c. The cut-off grade takes into account operating, mining, processing/haulage and G&A costs, excluding capital.
- 3) The Mineral Reserve is depleted for all mining to September 30, 2023.

- 4) The tonnes and grades are stated to a number of significant digits reflecting the confidence of the estimate. Since each number is rounded individually, the table may show apparent inconsistencies between the sum of rounded components and the corresponding rounded total.
- 5) The Mineral Reserve tonnages and grades are estimated and reported as delivered to plant (the point where material is delivered to the mill) and is therefore inclusive of ore loss and dilution.
- 6) CIM Definition Standards (2014) were followed in the calculation of Mineral Reserves.
- 7) Gold Mineral Reserve estimates were prepared under the supervision of Qualified Person P. Ganza, MAusIMM (CP).

15.3.2.2 Stope Design Parameters

Stope shapes have been designed using MSO with user-defined parameters based on orebody geometry, economic analysis and experience with mining geometric and operational constraints.

The following stope design parameters were applied within the mine design:

- Minimum footwall dip angles were set at 45°;
- Minimum mining widths (inclusive of planned dilution) of 2.5 m;
- Dilution of 0.25 m on the footwall and hangingwall of each stope shape (total of 0.5 m of dilution) applied as part of the stope optimisation process for the LHOS;
- The dilution is evaluated with the Mineral Resource model; and therefore, dilution carries the evaluated grade from the Mineral Resource Model (provided it is within the Measured or Indicated Mineral Resource categories).

15.3.2.3 Cut-off Grade Derivation

Costs are based on suppliers quotes, mining contractor costs or comparisons to Beta Hunt costs as per Section 21.2.2.2. The initial stopes were run at a cut-off grade of 2.0 g/t Au (diluted/modified stope grade). An opportunity exists to add to the mine plan by testing if stopes above the determined marginal cut-off of 1.6 g/t cut-off grade add to the economics of the project. An ore development cut-off grade of 0.6 g/t was applied which covers the processing and surface haulage cost, as mining and underground haulage of this material is a sunk cost required for access for stoping. Cut-off grade inputs and calculations are shown in Table 15-12 and Table 15-13.

The Spargos mine design and schedule are sensitive to revenue factors, so changes to recovery or gold price may impact economic areas as designed for this Mineral Reserve.

Table 15-12 Spargos Underground Mineral Reserves – net gold price calculation

Parameter	Unit	Value
Gold Price	US\$/oz	1,500
Exchange Rate	USD:AUD	0.7
State Royalty	%	2.5
Metallurgical Recovery	%	90
Net Price	A\$/oz	1,880
Net Price	A\$/g	60.5

Table 15-13 Spargos Underground Mineral Reserves – cut-off grade calculation inputs

Operating Cost	Unit	Operating Cost (inc Development)	Marginal Stopping Costs (no Development)	Development Cut-off	Total Mining Costs Including Capital Development
Mining Direct Costs	A\$/t	59.2	32.9		158.4
Mine Management & Technical Services	A\$/t	11.3	11.3		11.3
Site G&A	A\$/t	7.8	7.8		7.8
Haulage Cost	A\$/t	7.5	7.5	7.5	7.5
Processing Cost	A\$/t	35.5	35.5	35.5	35.5
Total Cost	A\$/t	121.2	94.9	43.0	220.4
Stope Cut-off Grade	g/t	2.0			
Incremental Stope Cut-off Grade	g/t		1.6		
Incremental Development Cut-off Grade	g/t			0.7	
Fully Costed Cut-off Grade	g/t				3.6

15.3.3 Mt Henry Project

The Mineral Reserve estimate has been carried out for the Mt Henry, Selene and North Scotia deposits, which together form the Mt Henry Project (MHP). The Mt Henry Deposit has had historical mining activity with previous owner Metals X commencing mining in 2016. Mining ceased in 2019 and there is an abandoned open pit, whereas Selene and North Scotia are both greenfields mining areas. Mining at Mt Henry was undertaken by Westgold between August 2016 and June 2019. Karora obtained the MHP tenements as part of the HGO acquisition in June 2019. Total mine production is 2.3 Mt @ 1.7 g/t for 127 koz (contained). Prior to Westgold, Australis Mining NL mined 112 kt @ 1.1 g/t from the Mt Henry Pit 2 area in the 1980s.

The Mineral Reserve estimate assumes mill feed from the MHP open pits is trucked and treated at the existing Higginsville Mill. The Mineral Reserve estimate calculations are based on a first principles mining cost estimate, with road transport, production rates, processing costs and metallurgical factors based on actual data.

15.3.3.1 Mineral Reserves Estimation Process

The MHP open pits have been the subject of previous studies. Consequently, parameters such as geotechnical design parameters, overland haulage costs and processing parameters through the Higginsville Mill have already been evaluated and these outcomes were utilised for the generation of this Mineral Reserve estimate. As an operating gold project, the Higginsville based costs and metallurgical factors can be considered to provide a level of confidence in these parameters. The mining costs were developed by Orelogy in 2021 (Karora, 2021a), and updated by Karora in 2023, from first principles assuming a conventional truck and shovel mining methodology. The cost estimate assumed a contract mining model and utilised up to date equipment operating and capital costs from original equipment manufacturers.

A process has been followed to convert the Mineral Resources to Mineral Reserves which is underpinned by design, schedule and economic evaluation. This process is described below and in the following sections.

- The following Mineral Resource models as described in Section 14 were provided by Karora to Entech Pty Ltd who were engaged by Karora to provide pit optimisation, design and schedule for the Mt Henry Project Mineral Reserves.

- Mt Henry *mt_henry_gcx_master_depleted_20190331_v.mdl*
- Selene/North Scotia *selene_nthscotia_201103_engineer.mdl*
- Mining ore loss and dilution were estimated by re-blocking each resource model to a 5 m x 5 m x 5 m for the Mt Henry and Selene Deposits and a 2.5 m x 2.5 m x 5 m size for North Scotia which also represents the minimum SMU size of the planned open pit fleet. While the resulting ore loss/dilution varies by area, the global mining recovery and dilution approximates the following:
 - Mt Henry: ore recovery = 92.7%; dilution = 29.4%
 - Selene: mining recovery = 86.0%; dilution = 0.0%
 - North Scotia: ore recovery = 67.2%; dilution = 70.9%
- Open pit optimisations were run by Entech on the diluted models described above using GEOVIA Whittle™ software. Modifying factors including mining costs, processing costs, selling costs, metallurgical recoveries and gold price were applied within GEOVIA Whittle™ and optimal shells were then selected as the basis for subsequent designs.
- Mine designs were then completed for the three mining areas.
 - Mt Henry – a northern and southern pushback around the existing Mt Henry pit as well as a new northern pit;
 - Selene – an ultimate pit was designed around the large Selene optimisation shell; and
 - North Scotia – a single ultimate pit design was designed.
- A life of mine (LOM) production schedule was then developed for the MHP open pits which assumed a 1.6 Mtpa ore production rate, matching the 1.6 Mtpa throughput rate for the Higginsville Mill. Mining productivity was based on the first principles model calculations which assumed a Caterpillar 6020 excavator matched to Caterpillar 777 haul trucks.
- The resulting mining schedule was evaluated by re-applying the modifying factors to the mining schedule physicals to ensure the designs and schedule were economically viable.

The Mineral Reserve estimate effective September 30, 2023 is summarized in Table 15-14.

Table 15-14 Mt Henry Project Gold Mineral Reserves at September 30, 2023

Sep-2023 Mineral Reserve	Proven			Probable			Proven & Probable		
	kt	g/t	koz	kt	g/t	koz	kt	g/t	koz
Mt Henry	9	1.0	0	920	1.5	45	929	1.5	45
Selene	7,199	1.3	299	2,560	1.3	106	9,759	1.3	405
Nth Scotia	0	0	0	142	1.8	8	142	1.8	8
Total	7,208	1.3	299	3,622	1.4	160	10,830	1.3	459

- 1) The Mineral Reserve is reported at a 0.8 g/t cut-off grade.
- 2) Key assumptions used in the economic evaluation include:
 - a. A metal price of US\$1,500/oz gold and an exchange rate of 0.70 USD:AUD.
 - b. Metallurgical recovery varies by deposit.
 - c. The cut-off grade takes into account operating, mining, processing/haulage and G&A costs, excluding capital.
- 3) The Mineral Reserve is depleted for all mining to September 30, 2023.
- 4) The tonnes and grades are stated to a number of significant digits reflecting the confidence of the estimate. Since each number is rounded individually, the table may show apparent inconsistencies between the sum of rounded components and the corresponding rounded total.
- 5) The Mineral Reserve tonnages and grades are estimated and reported as delivered to plant (the point where material is delivered to the mill) and is therefore inclusive of ore loss and dilution.
- 6) CIM Definition Standards (2014) were followed in the calculation of Mineral Reserves.

- 7) Gold Mineral Reserve estimates were prepared under the supervision of Qualified Person P. Ganza, MAusIMM (CP).

15.3.3.2 Cut-off Grade Derivation

The ore cost is a combination of the processing cost, any mining specific Mineral Reserve costs (e.g. rehandle, grade control etc.) and the road haulage to the Higginsville Mill. Summarised processing costs include an allowance for sustaining capital and tails dam construction on a dollar per tonne basis.

The net price calculation is detailed in Table 15-15; the resulting variable cut-offs used to define the Mineral Reserve are detailed in Table 15-16.

Table 15-15 Mt Henry Project Open Pit Mineral Reserves – net gold price calculation

Parameter	Unit	Value
Gold Price	US\$/oz	1,500
Exchange Rate	USD:AUD	0.7
State Royalty	%	2.5
Native Title Royalty	%	1.0
Net Price	A\$/oz	2067.9
Net Price	A\$/g	66.5

Table 15-16 Mt Henry Group Open Pit Mineral Reserves – cut-off grade calculation

Parameter	Material	Unit	Mt Henry	Selene	North Scotia	Source
Haulage Cost	All	\$/t	9.7	10.1	10.1	Actual Costs
Processing Costs (inc. Sustaining Capital)	All	\$/t	31.2	31.2	31.2	Site Forecast
Site G&A	All	\$/t	7.8	7.8	7.8	Site Forecast
Processing Recovery	Oxide	%	87	94	94	Metallurgical Testwork
	Trans	%	86	89	89	Metallurgical Testwork
	Fresh	%	86	89	89	Metallurgical Testwork
Cut-off Grade	Oxide	g/t	0.8	0.8	0.8	
	Trans	g/t	0.8	0.8	0.8	
	Fresh	g/t	0.8	0.8	0.8	

15.3.4 Other Open Pits

This section covers the calculation of the open pit Mineral Reserves for the Musket and Atreides open pits.

15.3.4.1 Mineral Reserves Estimation Process

A process has been followed to convert the Mineral Resources to Mineral Reserves which is underpinned by design, schedule, and economic evaluation. This process is described below and in the following sections.

- The following Mineral Resource models as described in Section 14 were used to complete pit optimisation, design and schedule for the Atreides and Musket Mineral Reserves.
 - Atreides *atrides_1701_depl.mdl*
 - Musket *musket_eng_20180331.mdl*

- Mining ore loss and dilution were estimated by re-blocking each resource model to a 2.5 m x 2.5 m x 5 m size which represents the minimum SMU size of the planned open pit fleet.
- Open pit optimisations were run by Karora on the diluted models described above using Deswik software Pseudoflow optimisation algorithm. Modifying factors including mining costs, processing costs, selling costs, metallurgical recoveries and gold price were applied within the software and optimal shells were then selected as the basis for subsequent designs.
- Mine designs were then completed for the two mining areas.
 - Atreides – a northern cutback and a new shallow pit to the south; and
 - Musket – a main pit to the south and a smaller northern pit.
- Designs were scheduled in Deswik, with tonnes and grade interrogated against the original resource model, with global averages for dilution (10%) and mining recovery (95%) applied.
- A production schedule was then developed for each pit separately with mining productivity based on a Caterpillar 6020 excavator matched to Caterpillar 777 haul trucks.
- The resulting mining schedule was evaluated by re-applying the modifying factors to the mining schedule physicals to ensure the designs and schedule were economically viable.

The Mineral Reserve estimate effective September 30, 2023 is summarized in Table 15-17.

Table 15-17 Atreides and Musket Gold Mineral Reserves at September 30, 2023

Sep. 2023 Mineral Reserve	Proven			Probable			Proven & Probable		
	kt	g/t	koz	kt	g/t	koz	kt	g/t	koz
Atreides	31	1.5	1	160	1.9	10	191	1.8	11
Musket	67	2.6	6	120	3.0	12	187	2.8	17
Total	99	2.2	7	280	2.4	21	378	2.3	28

- 1) The Mineral Reserve is reported at a 0.8 g/t cut-off grade for Atreides and a cut-off of between 0.8 g/t to 1 g/t for Musket depending on material type.
- 2) Key assumptions used in the economic evaluation include:
 - a. A metal price of US\$1,500/oz gold and an exchange rate of 0.70 USD:AUD.
 - b. Metallurgical recovery varies by deposit.
 - c. The cut-off grade takes into account operating, mining, processing/haulage and G&A costs, excluding capital.
- 3) The Mineral Reserve is depleted for all mining to September 30, 2023.
- 4) The tonnes and grades are stated to a number of significant digits reflecting the confidence of the estimate. Since each number is rounded individually, the table may show apparent inconsistencies between the sum of rounded components and the corresponding rounded total.
- 5) The Mineral Reserve tonnages and grades are estimated and reported as delivered to plant (the point where material is delivered to the mill) and is therefore inclusive of ore loss and dilution.
- 6) CIM Definition Standards (2014) were followed in the calculation of Mineral Reserves.
- 7) Gold Mineral Reserve estimates were prepared under the supervision of Qualified Person P. Ganza, MAusIMM (CP).

15.3.4.2 Cut-off Grade Derivation

The ore cost is a combination of the processing cost, any mining specific Mineral Reserve costs (e.g. rehandle, grade control etc.) and the road haulage to the Higginsville Mill. Summarised processing costs include an allowance for sustaining capital and tails dam construction on a dollar per tonne basis.

The net price calculation is detailed in Table 15-18; the resulting cut-offs used to define the Mineral Reserve are detailed in Table 15-19.

Table 15-18 Atreides and Musket Open Pit Mineral Reserves – net gold price calculation

Parameter	Unit	Atreides	Musket
Gold Price	US\$/oz	1,500	1,500
Exchange Rate	USD:AUD	0.7	0.7
State Royalty	%	2.5	2.5
Third Party Royalty	%	4	4
Third Party Royalty - Mitchell	A\$/oz	32	0
Net Price	A\$/oz	1,971.6	2,003.6
Net Price	A\$/g	63.4	64.4

Table 15-19 Atreides and Musket Open Pit Mineral Reserves – cut-off grade calculation

Parameter	Material	Unit	Atreides	Musket	Source
Haulage Cost	All	\$/t	5.63	10.23	Actual Costs
Processing Costs (inc. Sustaining Capital)	All	\$/t	35.15	35.15	Site Actuals and Forecast
Site G&A	All	\$/t	7.8	7.8	Site Forecast
Processing Recovery	Oxide	%	90	98	Metallurgical Testwork
	Trans	%	90	83	Metallurgical Testwork
	Fresh	%	N/A ⁽¹⁾	86	Metallurgical Testwork
Cut-off Grade	Oxide	g/t	0.8	0.8	
	Trans	g/t	0.8	1.0	
	Fresh	g/t	N/A	1.0	

1) Atreides Pit does not include any fresh material.

15.4 STOCKPILES

Stockpile Mineral Reserves are derived from Measured and Indicated Mineral Resource stockpiles associated with the mining of historical and active HGO open pits. Recovery (mining) of stockpiles is by front-end loader and trucks and, in places, excavator and trucks. Recovery of stockpiles is undertaken at HGO on an as-needed basis.

Loading, haulage and processing costs are applied to the Measured and Indicated Mineral Resource to determine Mineral Reserves. Haulage costs are aligned to the distance between the stockpile and the Higginsville Mill. Metallurgical recovery factors and royalties are applied to estimate the revenue generated by each stockpile. As stockpiles at HGO are treated on an incremental basis, they do not need to carry full site costs; stockpiles are deemed economic to treat as long as cost of reclamation, haulage and processing is covered by the revenue generated.

Remaining Mineral Reserves stockpiles are located at Hidden Secret, Mouse Hollow, Baloo, Challenge, Mitchell, Lake Cowan deposits (Napolean and Louis), Pioneer, Two Boys and Mt Henry and are summarised by general location in Table 15-20.

Table 15-20 Stockpile Mineral Reserve – HGO – as at September 30, 2023

Sep. 2023 Mineral Reserve	Proven			Probable			Proven & Probable		
	kt	g/t	koz	kt	g/t	koz	kt	g/t	koz
HGO Central Stockpiles	267	0.8	7	453	0.9	12	720	0.8	19
HGO Greater Stockpiles	138	0.7	3	116	0.8	3	254	0.8	6
Total	405	0.8	10	569	0.8	16	973	0.8	26

- 1) Key assumptions used in the economic evaluation include:
 - a. A metal price of US\$1,500/oz gold and an exchange rate of 0.70 USD:AUD.
 - b. Metallurgical recovery varies by deposit.
 - c. The economics of each existing stockpile takes into account operating, mining and processing/haulage costs.
- 2) The Mineral Reserve is depleted for all mining to September 30, 2023.
- 3) The tonnes and grades are stated to a number of significant digits reflecting the confidence of the estimate. Since each number is rounded individually, the table may show apparent inconsistencies between the sum of rounded components and the corresponding rounded total.
- 4) The Mineral Reserve tonnages and grades are estimated and reported as delivered to plant (the point where material is delivered to the mill) and is therefore inclusive of ore loss and dilution.
- 5) CIM Definition Standards (2014) were followed in the calculation of Mineral Reserves.
- 6) Gold Mineral Reserve estimates were prepared under the supervision of Qualified Person P. Ganza, MAusIMM (CP).

16 MINING METHODS

16.1 HIGGINSVILLE CENTRAL

16.1.1 Trident Underground

The Trident Deposit has three distinct mineralised zones, Western Zone (WZ), Eastern Zone (EZ) and Athena Lodes (AL). The Trident Deposit is to be exploited by underground mining methods with access gained from the previously mined Poseidon South open pit and underground workings.

Trident has some key, narrow mineralised zones; however, longhole open stoping will not be feasible due to the flat dipping nature of these zones. Airleg room and pillar stoping is proposed and planned in these zones, as it is a well-known and practiced mining method in various underground gold mines of Western Australia. The Trident Mineral Reserves were therefore optimised, designed and scheduled by mineral zone and mining method. The Trident mine also has several established mining areas and some remnant mining potential. These developed areas will require development/access rehabilitation and other areas will require new access and ore drive development.

The development to ore tonnes ratio is still quite attractive for Trident, but mining in various areas whilst also considering remnant mining will be reasonably challenging.

The Trident underground mine is accessed via an established portal and declines within the open pit, located close to the Higginsville Mill and mining offices. Pumping, ventilation, power and mine service infrastructure will be partly new and some existing equipment will be utilised.

16.1.1.1 Underground Infrastructure

The mine is accessed by portals and a series of declines throughout the mine. The declines are typically 5.5 m wide (W) x 5.8 m high (H), with a standard ore drive size of 4.5 mW x 4.5 mH. Lateral development profiles are well matched to the mobile fleet. Ore is hauled from the underground to surface via the decline where it is then transported via a separate surface haulage fleet to the mill.

As an established mine, key infrastructure such as underground communications, electrical reticulation, pumping and ventilation will be re-established; some of this infrastructure is available for re-use. Most of the primary development is interconnected for ventilation and ease of access.

A radio communications system will be re-established throughout the mine. Electrical power is available via Higginsville power station and will be distributed throughout the mine at 11 kV and transformed to 1 kV for use as required for the mine equipment. The primary pumping system will be re-established and will service the relatively dry mine workings expected. A secondary network of pumps will then remove water from work areas back to the primary pumping system to be removed to surface.

The Trident orebody will be ventilated utilising two intake shafts located at the southern and northern extents of the orebody and a central exhaust shaft. The decline also acts as an intake. The primary exhaust shaft is a 4 m diameter ventilation rise. The northern intake rise is a 3 m diameter hole. The southern intake rise is a 2.4 m diameter rise. Each intake rises will have ladderways allowing for egress.

The ventilation network will be able to supply 200 m³/s of fresh air to the underground, with capacity to increase to 240 m³/s.

Equipment will be maintained and serviced at the existing surface workshop.

There is an existing explosives magazine located at the top of the Poseidon Pit.

16.1.1.2 Mining Methods

The Trident mine planning considered two distinctly different mining methods. The main method will be a top down, mechanised long hole retreat stoping. Some flatter dipping, high-grade zones can be exploited by airleg room and pillar stoping (mechanised access and ore drive development). Current LHOS stope design dimensions are typically 20 m to 25 m high (following the typical historic level spacings) and vary in width from 4.5 m to 6 m with 15 m stope strike lengths (15 m strike lengths will ensure excellent stope dilution control).

Backfilling of stopes is not currently considered for the Trident mine plan. The airleg stopes will follow the typical stope design criteria as used in nickel areas at Beta Hunt. This will be a typical room and pillar stoping method (also known in Western Australia as a slot and holing method) with scraping into the ore drives located down dip. The ore will then be bogged with a small load-haul-dump (LHD) within these ore drives. The room and pillar design criteria used is based on sound geotechnical room/pillar design criteria where the pillar sizes are approximately square and consider a width to height ratio of 2:1 (3.5 m by 3.5 m pillars) on a 1.7 m to 1.8 m stope width. The pillars can then be stripped back to 2 m by 2 m pillars and a 3.5 m wide room and holing. The airleg stoping areas at Trident is reasonably small and surrounded by in situ rock, so the regional stability is considered excellent.

The typical LHOS ore cycle post ore drive development is:

- Drilling of blast holes using a longhole drilling rig;
- Charging and firing of blast holes;
- Bogging (mucking) of ore from the stope using conventional and tele-remote loading techniques;
- Loading of trucks with an LHD;
- Trucks haul ore to surface via the portal; and
- Surface trucks haul ore to the mill or the same trucks simply running to the run of mine (ROM) pad at the plant.

The typical airleg room and pillar stope ore cycle post ore drive development is:

- Drilling of blast holes using handheld pneumatic drills and 1.8 m drill steels (32 mm diameter drill bits);
- Charging and firing of blast holes at the end of each shift (shift change);
- Support of the roof and pillars by bolting and, in some areas, mesh;
- Scraping of the ore down into the ore drive (located down dip) of the slots and holings;
- Bogging (mucking) of ore within the ore drives with a small LHD and hauling (by LHD) to ore stockpiles;
- Loading of trucks with an LHD at the ore stockpiles;
- Trucks haul ore to surface via the portal; and
- Surface trucks haul ore to the mill or the same trucks simply running to the ROM pad at the plant.

Historically, the ground conditions at Trident are generally good to very good. The site has an extensive history of mining performance and has developed guidelines to respond local conditions. A ground control management plan will be put in place on site and will be used during mine planning, mine development and production.

Lateral development drives are excavated using mechanised twin boom jumbos, with vertical development excavated using production drill rig.

16.1.1.3 Hydrology

The most significant water related hazard for the Trident underground mine relates to surface drainage and inrush potentials to the portal and base of mine workings during heavy rainfall events.

Surface water culverts around the margins of the Poseidon South Pit (PSP) are designed to convey up to 27 m³/s of surface water runoff generated during a 1-in-100 year rainfall event.

The Poseidon South pit is capable of storing approximately 121,000 m³ of water in the south end of the pit. This capacity will be maintained to advantage by pumping the water out of the southern end of the Poseidon South Pit to the Poseidon North Pit, located on Karora tenement M15/289. The Poseidon North Pit is 600 m to the north of the Poseidon South Pit. The Fairplay North Pit to the south also provides storage capacity.

Local groundwater inflows into the developing underground workings are expected range between 1 l/s to 4 L/s.

16.1.1.4 Geotechnical

A detailed geotechnical assessment of the Trident mine environment was conducted in 2006. The focus of the assessment was the determination of geotechnical guidelines for mine planning in regard to development and extraction layout, ground support, stope sizes, stoping sequence and backfill.

Synthesising the available stress data leads to the likely stress field estimate for Trident at a notional 400 m depth, shown in Table 16-1.

Table 16-1 Trident Principal Stress

Principal Stress	Dip/Direction	Magnitude
Major Principal Stress	Slight dip to the NNE	43 MPa
Intermediate Principal Stress	Shallow dipping to the WNW	29 MPa
Minor Principal Stress	Steep dipping to the ESE	12 MPa

Ground classification forms the basis for estimation of stability of stope walls and crowns, and of rock bolt support pressure requirements. The Barton system classification ratings for Q' for the most likely cases are shown in Table 16-2.

Table 16-2 Trident Q' by Area

Area	Q'
Eastern/Western Zone ore	31.7
Athena Ore	42.2
Gabbro	31.7
Ultramafic/pyroxenite	29.8
Gabbro brecciated zone	1.8

16.1.1.5 Geology

The Trident gabbros are competent and show more foliation than is usual for these rock types in the Goldfields, suggesting the proximity of the large regional shear.

The ultramafic, particularly nearer mineralisation where there is tremolite alteration, appears to be a significantly more competent rock mass than the typical ultramafics associated with nickel sulphides in the Goldfields.

Mineralisation is complex, which means for mining that stope boundaries will need to be flexible. Experience can be gained from the old Poseidon South Underground (PSU) workings. The PSU followed the Western Main Vein for three levels, and recent exploration drilling indicates that the Trident Athena Lodes are possibly a continuation of the previously mined Western Main Vein.

Gabbro forms both the hangingwall and footwall of the EZ and WZ. However, the Athena lodes are complex and variable, including ultramafic or pyroxenite on one or both sides of the contacts.

Boundaries between mineralisation and waste are definite but irregular. Mineralisation comprises a mixture of dominant steep and flat dip veins, ladder veins, and minor veins and stringers spiking into the hangingwall and footwall. Foliation is thought to be more intense within about 10 m of the ore.

The Trident Deposit is in a similar geological setting to PSP and PSU. However, ground conditions and behaviour from the PSU and PSP might not strictly apply to Trident, but are likely to be similar. Fault zones and continuous broken zones are the main issues affecting stope stability at Trident. The Poseidon Thrust is a regional-extent intensely sheared reverse fault located at the contact between the sediments and the basalts. It strikes north to NNE, is moderate/steep dipping to the east, and is tens of metres wide and lies 150 m east of Trident.

The following two dominant fault groups are identified in the Trident environment:

- West to northwest dipping (about 60° toward 310°), of which the 'CP' Fault is known in the pit. This fault is thought to contact the southern end of the WZ. It is chloritized and broken over a 3 m to 5 m true width, within a zone of low RQD values up to 20 m wide.
- Southeast dipping (about 70° toward 140°), of which some were mapped in the old underground workings.

A set of subparallel but discontinuous north-south striking subvertical fracture zones about 1 m to 5 m wide have been interpreted, closely related to the gabbro/ultramafic contact. Some of these are quite close to foliation orientations.

Additionally, numerous brecciated zones have been identified in drill core. These zones are 3 to 5 m wide, with RQD between 0 to 75, variably chloritic and locally brecciated, with a tendency for

them to be in and near the EZ region. Orientation is unclear, but it is suspected these zones are parallel to foliation, and further investigation is required for stope hangingwall stability.

Foliation trends either 70°–90° toward 95° or 70°–90° toward 280°. Foliation is the dominant structure in frequency of occurrence, but not necessarily the weakest. Much foliated drill core has high strength.

Foliation is more intense in the hangingwalls and footwalls immediately surrounding ore zones (i.e. to about 10 m from the ore), but is largely absent within the veined ore zones. Thus, foliation needs to be considered as a potential weakness plane in the determination of stope wall stability.

Tensional veins and shear veins are dominant at Trident, while laminated veins are less common. Most veins are under 30 cm thick, but the Athena 30 Lode at over 5 m is an exception. The veins thus could generate an irregular orebody outline, and stringers may form weakness planes in the hangingwalls and footwalls. While veins overall tend to strike approximately north-south, dip is very widespread.

Across Trident, six joint defect sets were identifiable, but only two or three are expressed at any locality. Slickensides lineations were present on some surfaces. Most joints are short ~3 m to 6 m is common with few exceeding 20 m in length.

16.1.1.6 Rock Properties

The Gabbro is among the strongest gabbro in Western Australia, with 307 MPa average unconfined compressive strength (UCS) being well above the 263 MPa regional average and eclipsed only by Junction dolerite. At depth (>750 m), the gabbro will potentially be very strain-burst prone. At 19 MPa, the tensile strength is very high, exceeding even Junction. This implies high abrasivity, i.e. high bit wear, drilling costs, tyre damage.

The Ultramafic UCS is 46 MPa at the regional average. However, tested samples failed along the steeply dipping foliation and the Trident ultramafic is probably a little stronger than the tests suggest. 'High Stress' effects in ultramafic could begin as shallow as 135 m and more likely at 300 m. It would be prudent to avoid ultramafic development below 300 m. The single pyroxenite sample strength was 50% greater than that of the other ultramafics.

16.1.1.7 Mine Design Parameters

Trident's planning (design and scheduling) considered two different mining/stopping methods. Table 16-3 best depicts the design criteria for both these methods:

Table 16-3 Stope design criteria

Description	Handheld Stopping (Room and Pillar)	LHOS (20m vertical level spacing)
Minimum Stope width	1.7m (true width)	4.5m (true width)-Target
Target ore zone for drilling	1.7 to 1.9m (true width)	2m (true width)
Planned dilution (total) – included in minimum stope width	0.2m	2m
Strike length (per stope or cut)	1.8m	15m
Vertical Level Spacing	Maximum 50m	20m to 25m
Estimated Stope Dip Lengths	64.5 to 73m	+24m to 28m
Maximum stope width	2.5m with footwall ripping	10m
Minimum dip (stopping area)	25o	42o
Maximum dip (stopping area)	45o	N/A
Unplanned dilution	0.2m fixed	0.5m
Final Stope width (evaluation)-Planned + unplanned overbreak - (true width)	2m	4.5m
Minimum intact rock pillar between footwall and Hangingwall lodes	6m	6m

The mine designs were loaded into Deswik software. Figure 16-1 and Figure 16-2 depict the designs concluded for Trident.

Figure 16-1 Trident Underground Mineral Reserves shows existing pit and underground workings looking west

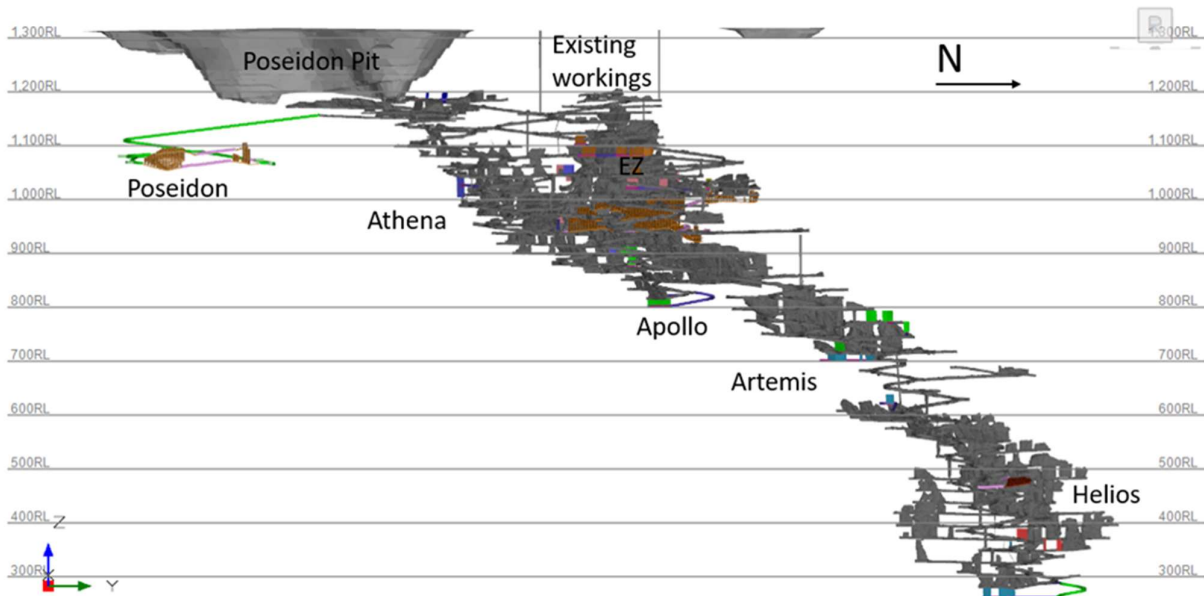

Figure 16-2 Trident Underground Mineral Reserves shows existing pit and underground workings looking North

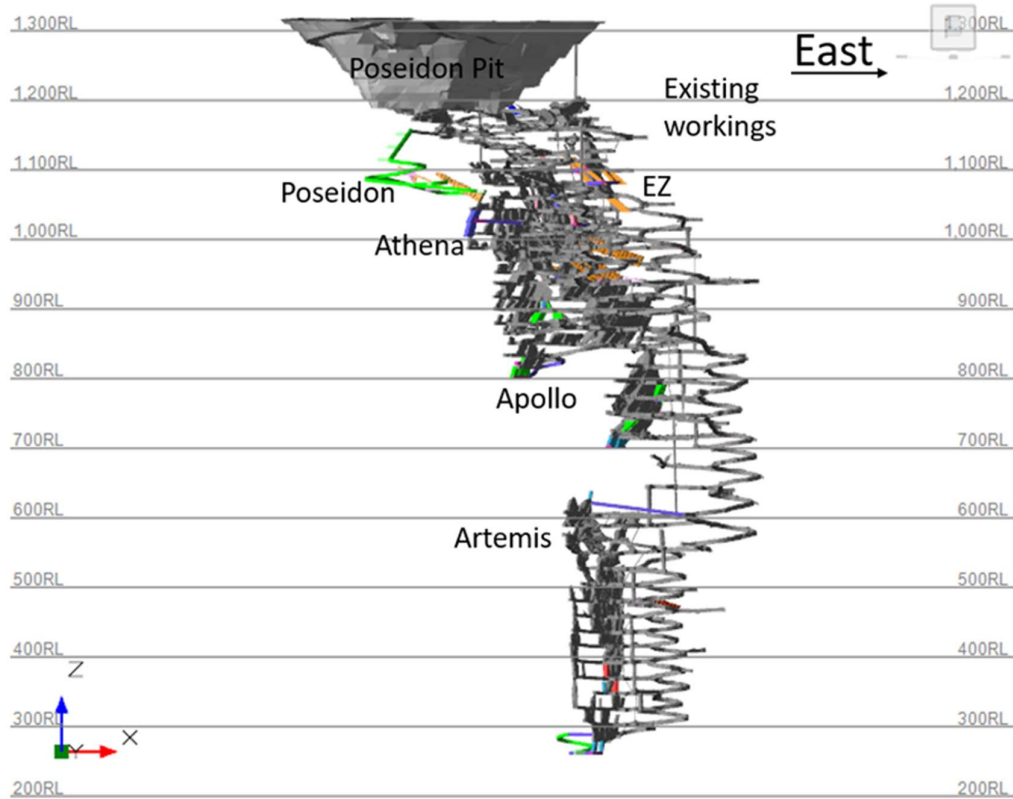

Figure 16-3 and Figure 16-4 depict schematic layouts for each of the designed mining/stopping methods, LHOS layout and airleg room and pillar mining/stopping.

Figure 16-3 LHOS design layout

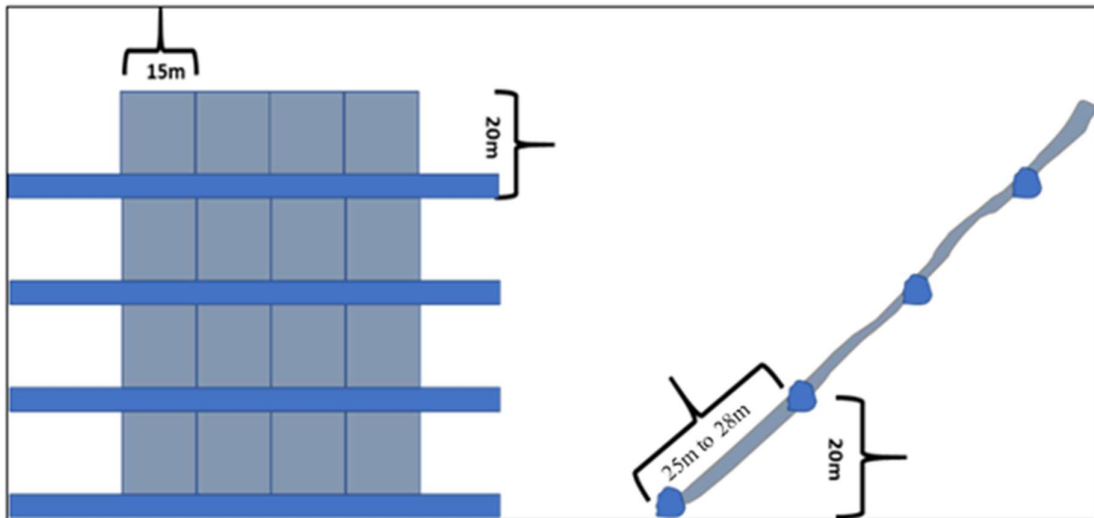
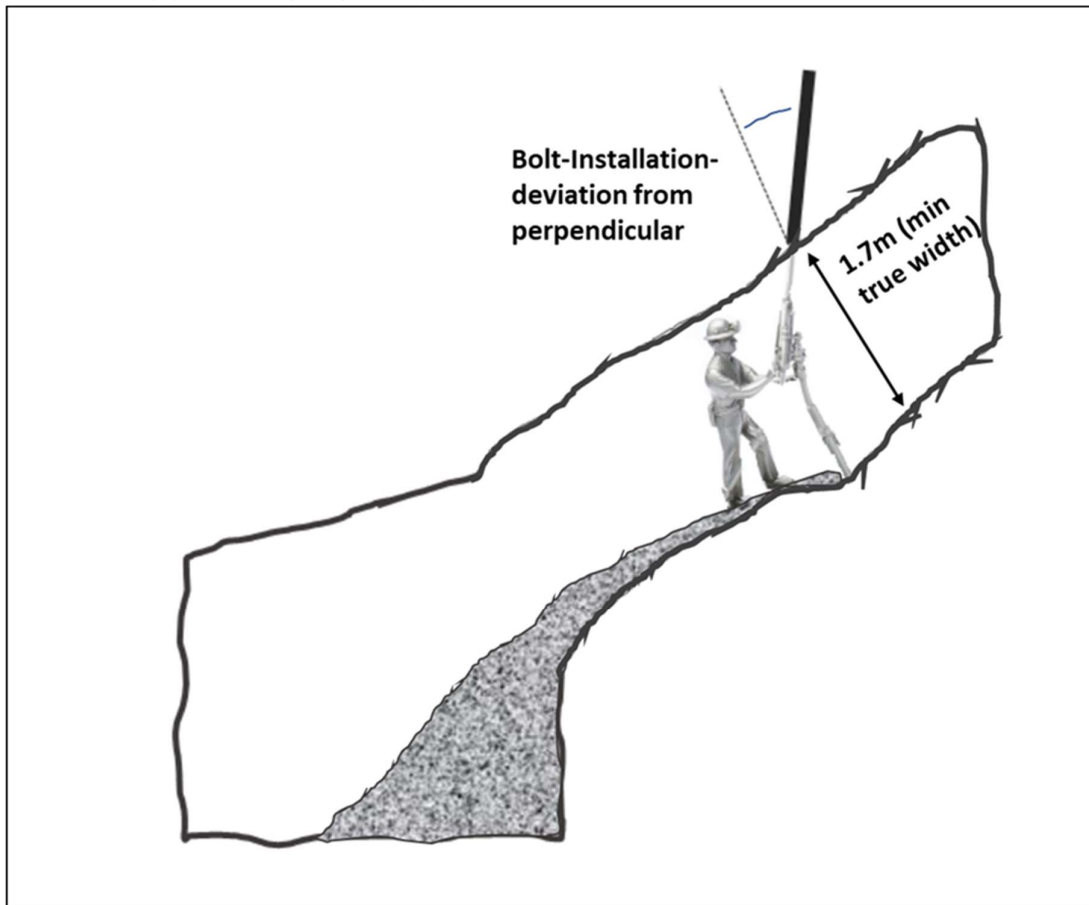

Figure 16-4 Airleg (room and pillar) mining layout – side view



16.1.1.8 Mine Scheduling

The mining schedule for the LOM) plan was generated using Deswik mine planning software. Once the development and stope designs are produced, they are evaluated in Deswik against the geological block model. Development and stope shapes are then reviewed and included in the schedule if they are economic to mine. All activities that make up the stoping cycle, such as production drilling, charging and bogging, are added into the mine schedule. The development and stoping activities are then linked in a logical extraction sequence which considers mining practicality, geotechnical and productivity constraints. Each task has an equipment resource applied to it, with schedule productivities based on current site performance and parameters appropriate to the equipment being used.

The current mine life is scheduled over 35 months (subject to further schedule refinements), shown in Figure 16-5.

Figure 16-5 Trident Mineral Reserves Schedule

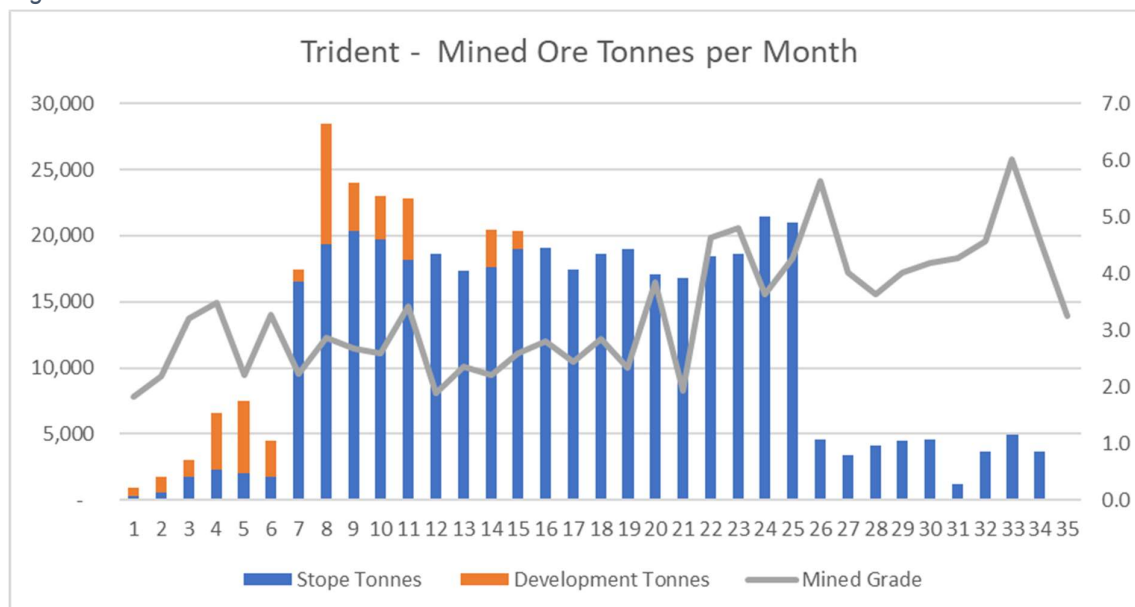

16.1.1.9 Mobile Equipment

The mine equipment proposed for Trident is industry standard trackless underground diesel equipment constructed by reputable manufacturers and well suited to current site operations. The primary underground fleet is shown in Table 16-4.

Table 16-4 Primary underground fleet

Unit Description	Unit Quantity
Twin Boom Jumbo	1–2
Production Drill	1
10 t LHD	2
40 t Truck	2
Integrated Tool Carrier	2

16.1.1.10 Labour Estimate

The cost model simulated the following labour requirements for the scheduled production at Trident, shown in Table 16-5.

Table 16-5 Labour estimate

Labour	Maximum	Year 1	Year 2	Year 3
Jumbo Operators	5	5	4	0
Charge-Up Operators	6	6	6	3
Actual Airleg Miners	12	8	12	10
Scraper Operators	4	3	4	4
Airleg Project Manager	1	1	1	1
Airleg Shift Supervisor	3	3	3	3
Airleg Safety Trainer	3	3	3	3
Airleg Fitter	3	3	3	3

Labour	Maximum	Year 1	Year 2	Year 3
Long Hole Drill Operator	3	3	3	3
LHD Operators	3	3	3	3
Truck Operators	6	6	6	5
Grader Operators	3	3	3	3
Water Cart Operators	3	3	3	3
Serviceman	7	7	7	7
Storeman	1	1	1	1
Nipper	1	1	1	1
Lead Hand Fitter	2	2	2	2
Fitters	5	5	5	4
Drill Fitter	2	2	2	1
Light Vehicle Fitter	1	1	1	1
Electricians	3	2	3	1
Project Manager	1	1	1	1
Mine Foreman	2	2	2	2
Project Engineer	1	1	1	1
Shift Supervisor	4	4	4	4
Maintenance Senior Leading Hand	2	2	2	2
Mining Engineer	1	1	1	1
Geologist	2	2	2	2
Total Labour	89	84	89	75

16.1.1.11 Site Layout

Trident is a historical mine with good existing development drives and some existing infrastructure; some additional infrastructure was planned and costed for this mine plan. Existing key infrastructure includes the following:

- Ramp access to underground mine (from the open pit) exists.
- A surface workshop is available to be used for major maintenance and routine services for the mobile equipment fleet.
- A ventilation system that uses the decline and two additional ventilation rises exists. Additional ventilation fans were included in the cost estimate to re-equip the ventilation network at Trident.
- A dewatering system exists with some piping and some pumps that require installation to recommission Trident mine.
- Management and administration offices.

Utilities provided to the mine include:

- Power;
- Service water; and
- Compressed air.

Figure 16-6 Oblique aerial view of Trident Portal inside Poseidon South Pit looking north.



16.1.2 Open Pits

This section describes the mining methods applicable to the Mitchell and Pioneer Mineral Reserves.

16.1.2.1 Open Pit Mining Infrastructure

As most of these open pits are routine drill, blast, load and haul operations located close to the Higginsville Mill, no additional mining infrastructure will be required. As part of the mining costs and contractor costs, equipment parking areas and small/fit-for-purpose maintenance areas will be allocated.

16.1.2.2 Mining Methods

The mining method for these open pits are drill, blast loading by excavator and trucking the waste rock to a dedicated waste rock dump area close to the pit and ore trucked to a local pit stockpile or directly trucked to the Higginsville Mill.

Mining will take place in benches with fitch loading (on either 2.5 m or 3 m high fitches). The open pit operations require diligent ore control/grade control procedures and resources. Grade control RC drilling will be performed ahead of blasting when required with the drilling chips samples assayed. In combination with the planning block model, zones within the ore bench are demarcated (by coloured tape/spray or a combination of the two) to define if a parcel of ore is low grade, medium grade or high grade.

The post loading grade control process is important to ensure the reconciliation is in line with planning and to ensure ore modifying factors are reasonable and follow due process.

The typical open pit mining cycle involves the following:

- Demarcation (on each bench level) of ore/waste and low-grade zones;
- RC drilling (grade control drilling prior to mining to refine/update waste/ore zones);
- Bench drilling floor preparation and survey depths for each blast hole (depth/lengths of each blast hole are key to ensure bench floor controls);

- Drilling of blast holes;
- Review and QA/QC of blast holes to ensure they are drilled to design;
- Re-drilling of any holes not deemed correct/appropriate;
- Charging and firing of blast holes;
- Loading of the heave;
- Loading of the flitches, loading to be supervised in ore blocks to ensure correct truck destinations; and
- Trucks haul ore to either a lower grade stockpile close to the open pit or directly to the Higgsville Mill

16.1.2.3 Hydrology

Most of the open pits (historical pits) in the Higgsville Greater area have groundwater inflows and there is obvious rain/surface water ingress throughout rain events. Hydrogeological modelling indicates that expected groundwater inflow would be in the order of 10 L/s for Mitchell and <10 L/s for Pioneer. These volumes of water will be disposed of via normal dust suppression activities during the course of mining.

Surface water ditches, culverts and bund walls in places around the pit will be designed to divert surface water runoff away from the open pit operations (as far as practicable). These designs will be informed by hydrogeological modelling.

16.1.2.4 Geotechnical

The Higgsville Central open pits have separate geotechnical criteria for each area and in the case of the Mitchell open pit, it is within an historical open pit.

The Mitchell group open pits have an average depth of 40 m (below surface). This is considered extremely shallow and there are excellent existing slopes/pit voids that were used to inform the geotechnical criteria shown in and Table 16-6.

Table 16-6 Mitchell geotechnical design criteria

Criterion	Value	Description
Top 15 m to 20 m:		
Face Height	≤ 20 m	
Face Angle	60°	
Berm Width	7 m	main Mitchell pit
Inter Ramp Angle	45°	Remain within 45°

Pioneer has a defined and distinct set of geotechnical design criteria as developed by a competent geotechnical engineer and are depicted in the slope design figures in Table 16-7.

Table 16-7 Pioneer geotechnical design criteria

Criterion	Value	Description
Northern Pit Sector:		
Face Height	≤ 10 m	Natural surface (~ 294 mRL) to 265 mRL
	15 m	265 mRL to 250 mRL (proposed base of mining)
Face Angle	55°	Natural surface (~ 294 mRL) to 265 mRL
	70°	265 mRL to 250 mRL (proposed base of mining)
Berm Width	5 m	at 285 mRL & 275 mRL
	6 m	at 265 mRL
Inter Ramp Angle	40°	within soils and completely weathered rocks
	53°	within transitional and fresh rocks
Southern Pit Sector:		
Face Height	≤ 10 m	Natural surface (~ 291 mRL) to 265 mRL
	15 m	265 mRL to 235 mRL
	20 m	235 mRL to 195 mRL (proposed base of mining)
Face Angle	55°	Natural surface (~ 291 mRL) to 265 mRL
	60°	265 mRL to 235 mRL
	70°	235 mRL to 195 mRL (proposed base of mining)
Berm Width	5 m	at 285 mRL & 275 mRL
	6 m	at 265 mRL & 250 mRL
	7 m	at 235 mRL & 215 mRL
Inter Ramp Angle	40°	within soils and completely weathered rocks
	46°	within transitional rocks
	54°	within fresh rock

- 1) An acceptable alternate design is to use 80° faces and 10 m wide berms within fresh rocks (below 235 mRL).

16.1.2.5 Historical Mining

There are several open pit voids/historical open pit operations in and around the Higginsville Central open pit target zones. With the abundance of historical mining, existing pit walls pointed to reasonably good to fair ground conditions with minimal major slope damage. There will naturally be the need to account for pit specific geological structures and jointing, and the relative face angles to these features and joints are very important as it could increase the probability of failure.

It is furthermore advised that slope monitoring systems be considered when starting to develop these open pits at depths greater than 30 m. A geotechnical engineer will review each pit design and may require further design alterations. These should be facilitated at or prior to mining commencement at the respective open pits.

16.1.2.6 Mine Design

Table 16-8 depicts the typical pit design criteria for each of the open pits.

Table 16-8 Pit design parameters

Description	Mitchell	Pioneer
Bench Height m	10	12–18
Typical Face Angles (Oxides)	60°	55°
Typical Face Angles (Transition Rock)	60°	60°
Typical Face Angles (Fresh Rock)	N/A	70
Typical Berm Width (Oxides) m	7	5
Typical Berm Width (Transition Rock) m	5	6
Typical Berm Width (Fresh Rock) m	N/A	7
Overall Slope Angles (Ranges)	40°–45°	40°–54°
Ramp Width m (Single Lane – Dual Lane)	8–12.5	8–12.5
Ramp Inclination %	11	10-12
Pit Depth (max) m	40	93

The mine designs were developed in Deswik software. Figure 16-7 and Figure 16-8 depict the pit designs for the Higginsville Central open pit deposits.

Figure 16-7 Mitchell Open Pit Mineral Reserves

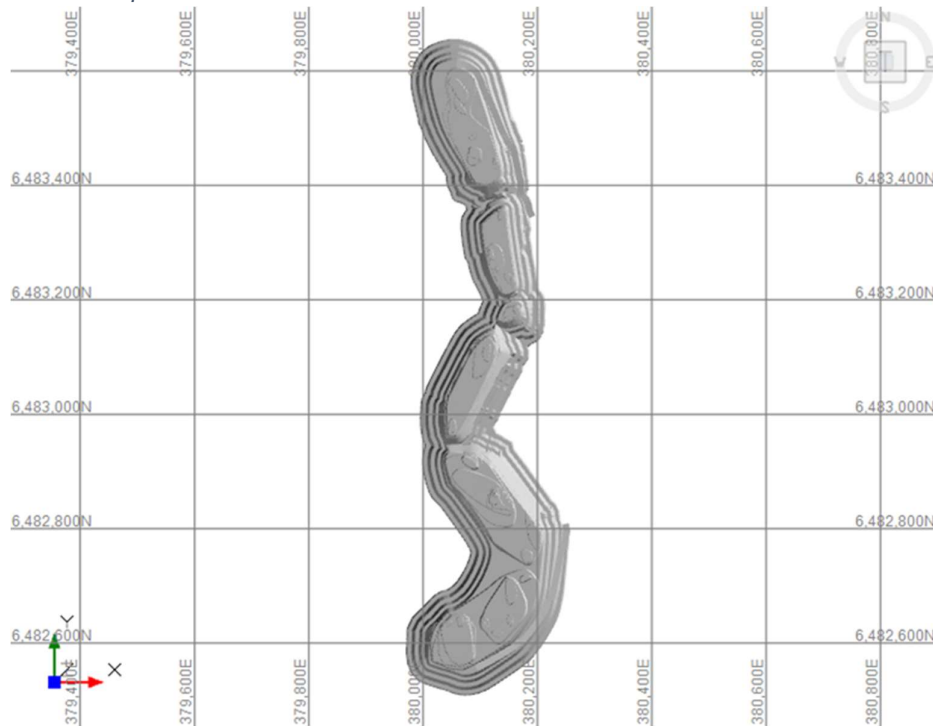
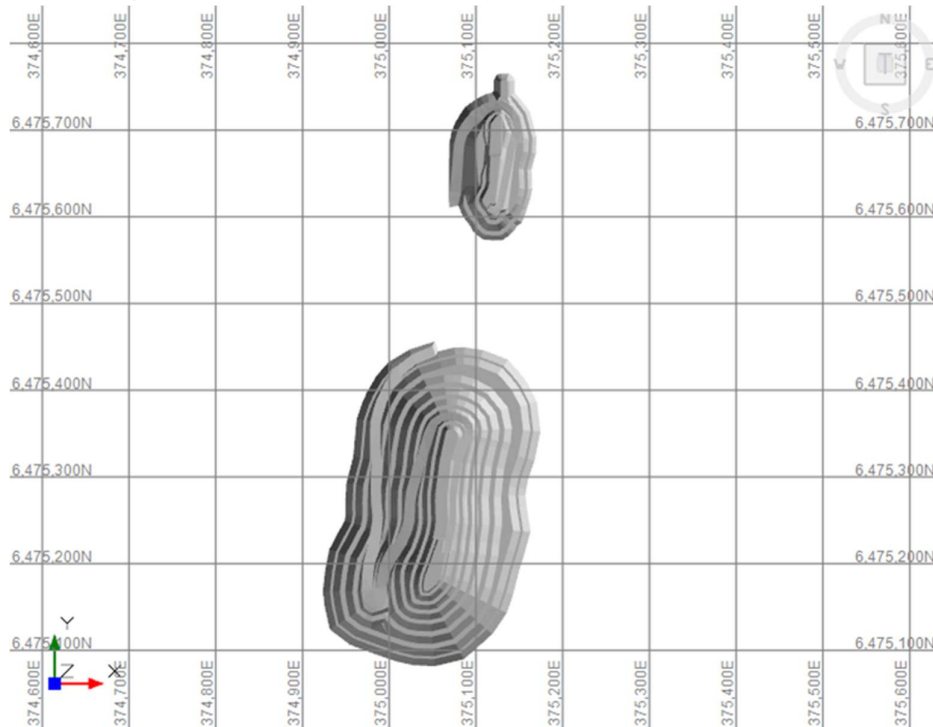

Figure 16-8 Pioneer Open Pit Mineral Reserves



16.1.2.7 Mine Scheduling

The open pits were scheduled in the Deswik software package. Mining production rates were determined using historical actuals, given the current contract mining fleet at Pioneer will be similar to the fleet employed at Mitchell. Maximum dig rates were set to 300 kbcm/month for Pioneer and 150 kbcm/month for Mitchell, and reduced depending on available working areas, interactions with other activities in the pit (grade control drilling or blast hole drilling) and working bench area. The mining schedules are considered realistic and achievable considering past performance. Dig rates are planned to be lower at Mitchell as mining of the paleochannel clays is expected to require smaller fleet due to the selective nature of mining, as well as production rates being slowed by the requirement of waste sheeting to create a suitable running surface on the working floor of the pit.

The Mitchell Mineral Reserves Schedule is detailed in Table 16-9.

Table 16-9 Mitchell Mineral Reserves Schedule

Mitchell Mineral Reserves Schedule	Unit	Total	Month 1	Month 2	Month 3	Month 4	Month 5	Month 6	Month 7	Month 8	Month 9
Mined Ore Tonnes	kt	205	-	-	1	22	72	6	6	29	70
Mined Grade	g/t	2.3	-	-	2.0	1.8	2.1	2.2	2.5	2.4	2.6
Mined Ounces	koz	15	-	-	0.0	1.3	4.8	0.4	0.4	2.3	5.8
Mined Waste Tonnes	kt	2,176	264	258	269	249	210	257	250	246	173
Total Mined Tonnes	kt	2,139	264	258	269	272	282	262	256	275	-
Strip Ratio	W:O	10.6	-	-	269.0	11.3	2.9	42.8	41.7	8.5	2.5

- 1) The tonnes and grades are stated to a number of significant digits reflecting the confidence of the estimate. Since each number is rounded individually, the table may show apparent inconsistencies between the sum of rounded components and the corresponding rounded total.

The Pioneer Mineral Reserves Schedule is detailed in Table 16-10.

Table 16-10 Pioneer Mineral Reserves Schedule

Pioneer Mineral Reserves Schedule	Unit	Total	Month 1	Month 2	Month 3	Month 4	Month 5	Month 6	Month 7	Month 8
Mined Ore Tonnes	kt	233	27	-	34	39	29	18	57	27
Mined Grade	g/t	2.1	2.3	2.4	1.7	1.4	1.9	2.0	2.4	3.1
Mined Ounces	koz	16	2	-	2	2	2	1	4	3
Mined Waste Tonnes	kt	3,491	576	611	631	529	523	317	208	96
Total Mined Tonnes	kt	3,724	604	611	665	568	552	335	265	123
Strip Ratio	W:O	15.0	21.3	-	18.6	13.6	18.0	17.6	3.6	3.6

- 1) The tonnes and grades are stated to a number of significant digits reflecting the confidence of the estimate. Since each number is rounded individually, the table may show apparent inconsistencies between the sum of rounded components and the corresponding rounded total.

16.1.2.8 Mobile Equipment

The open pits are planned/mined by means of open pit excavators and haul trucks (typical small open pit mining equipment). The mining is done by contractors (reputable open pit Australian mining contractors) and the specific equipment units may vary as the contractor sees fit. At present, mining of Pioneer is completed using a 120 t and an 80 t excavator matched to a fleet of 60 t capacity trucks. Mining at Mitchell is expected to be more selective with an 80 t excavator used with a fleet of 40 t Moxy trucks or similar.

16.1.2.9 Site Layout

These open pits do not need or do not have any specific site infrastructure. The only basic facilities they will have is parking areas for the mining equipment, possibly one or two small on-site mobile offices and ablutions, a mobile service truck or tank and rock dump laydown areas (low grade ore and waste rock dump areas). There were no specific waste rock dump designs completed for each pit, but there is ample dumping space at each pit/area and the typical dump design criteria can be described as in Table 16-11.

Table 16-11 Dump design criteria

Criteria	Value
Angle of dump repose	34°
Final remediated batter slope angle	15°
Dump lift height	15m
Dump safety berm	15m

16.2 HIGGINSVILLE GREATER

16.2.1 Chalice Underground

16.2.1.1 Underground Infrastructure

The Chalice underground mine will be accessed through an existing portal and the main decline throughout the mine. The decline is typically 5.5 mW x 5.8 mH, with a standard ore drive size of 4.5 mW x 4.5 mH. Lateral development profiles are well matched to the mobile fleet. Ore is hauled from the underground to surface via the decline where it is then transported via a separate surface haulage fleet to the mill.

Chalice is not an active underground mine and therefore key infrastructure such as underground communications, electrical reticulation, pumping and ventilation will need to be re-established.

Chalice will be ventilated through a series of intake airways. The main intake airway through the portal will provide 35 m³/s to 40 m³/s of air; other intakes are the Resolute 1200 airway and the ATL 1123 RAD. A total of 130 m³/s to 140 m³/s of intake air is available and the Chalice equipment models suggest this will be sufficient (three loaders and three trucks, which drive the biggest air flow requirements).

Equipment is maintained and serviced at a surface workshop (included in the additional mining infrastructure required at Chalice).

16.2.1.2 Mining Methods

The mine planning of Chalice (underground only) considered top down, mechanised long hole retreat stoping. The current LHOS stope design dimensions are 20 m to 25 m high (following the typical historic level spacings) and vary in width from 4.5 m to 6 m with 15 m stope strike lengths (15 m strike lengths will ensure excellent stope dilution control).

Backfilling of stopes is not currently considered for the Chalice mine plan and based on the geotechnical analyses and studying the historical mined out stopes, it is believed that a retreat stoping sequence with natural low grade pillars at relatively shallow depths should prove to be reasonably stable excavations. Chalice will require various areas and access development ends to be rehabilitated. The rehabilitation will require some stripping and removing of loose rock and rusted or damaged ground support elements and the resupporting of these development ends. This is a reasonably fast and inexpensive task, but should be planned within the jumbo efficiencies and cycles to optimise access development and new stope zones.

The typical LHOS ore cycle post ore drive development is as follows:

- Drilling of blast holes using a longhole drilling rig;
- Charging and firing of blast holes;
- Boggging (mucking) of ore from the stope using conventional and tele-remote loading techniques;
- Loading of trucks with an LHD;
- Trucks haul ore to surface via the portal;
- Surface trucks haul ore to the mill or the same trucks simply running to the ROM pad at the plant.

Higher grade ore positions are named Atlas and Olympus. The Atlas-Olympus line defines a shallow north plunging shoot trend that extends for 700 m in length with widths up to 50 m.

These mineralised positions are beneath the pit and further north down-plunge (Atlas in the south, Olympus to the north).

Down dip of the Olympus 'pipe', the grades often split into discrete fingers of mineralisation. Generally, ore widths taper up-dip. The high-grade position of Olympus is largely free of felsic intrusives, but for 0.5 m to 3 m scale dykes (of variable directions) that at times have increased grades.

Central to Olympus, a hangingwall felsic intrusive is adjacent to ore, but northwards it increasingly diverges. Coincidentally south of that position, the high-grade shoot shifts significantly east and up-dip.

Low grades of greater dimensions essentially shell the high-grade position. This includes up and down-plunge south and north, respectively. Grades are sharply lower, often <2 g/t. It extends for over 500 m in length from 6,478,875 mN to 6,479,335 mN, is up to 50 m wide and 150 m high. It essentially abuts the Atlas position up-plunge in the south. Down-plunge to the north, the shoot is smaller with increasing influence of felsic intrusives, but also is less well defined.

16.2.1.3 Hydrology

The most significant water related hazard for the Chalice underground mine relates to surface drainage and inrush potentials to the portal and base of mine workings during heavy rainfall events. The climate in the Chalice area is semi-arid with a mean annual rainfall of approximately 280 mm. Annual evaporation far exceeds rainfall and as such, there are no permanent fresh water streams in the immediate Chalice site area. Surface water flows only occur during extended heavy rainfall events, generally associated with thunderstorm activity and rain bearing depressions.

The Chalice site has an elevation of 350 mAHD and is approximately 2 km from the top of the catchment to the east (385 mAHD) and slopes downward to the west toward broad shallow salt lakes that serve as drainage basins (310 mAHD). As such, drainage trends westerly. Based on information contained within hydrogeological studies, no observable minor drainage lines pass through the Chalice site area. Overland or sheet flow is expected to impact the site; however, flood impact will be relatively low and can be managed by use of nominal diversions (channels/bunds) on the 'upstream' side of mine infrastructure.

Historical reports suggest a large proportion of mine water created underground is the result of surface and underground exploration drill holes intersecting water structures which lie above the underground workings. The inflow into the mine is approximately 30 L/s. The main water structures lie above the Atlas mining area and beneath the Resolute Diamond drill drive. Pump stations existed on the 1152 and 1028 levels and will be re-established in order to keep the underground workings dewatered. Water will be pumped to Aphrodite to use as process water or discharged under license to the west lakes near Chalice.

16.2.1.4 Geotechnical

A representative selection of borehole cores from Chalice underground was collected for UCS, Young's Modulus and Poisson's Ratio determinations. The results are summarised in Table 16-12. Based on the UCS values for failure through intact rock (UCS A+C), the felsic intrusives and amphibolites found at Chalice can be classified as extremely strong.

Table 16-12 Chalice rock strength properties

Rock Type	UCS (MPa) A+C			UCS (MPa) Total		
	Mean	Std Dev	No. Samples	Mean	Std	No. Samples
Felsic Intrusives	256	39	8	256	39	8
Amphibolite	221	77	6	181	81	10
Rock Type	Young's Modulus (GPa)			Poisons Ratio		
	Mean	Std Dev	No. Samples	Mean	Std	No. Samples
Felsic Intrusives	72	10	4	0.34	0.06	4
Amphibolite	76	2	4	0.28	0.06	4

Notes-

UCS = Uniaxial Compressive Strength standardised for 50mm core diameter.

UCS_{A+C} = Uniaxial Compressive Strength data from core that failed either due to axial splitting (A) or multiple cracking (C).

UCS_{TOTAL} = Total Uniaxial Compressive Strength data including shear failure.

The in situ stress environment has not been measured at Chalice for the current or previous geotechnical assessments. The closest stress measurement results (Table 16-13) to Chalice are from Avoca's Trident underground mine which utilised the laboratory-based Acoustic Emission Method to test borehole core collected at depths of 411 m and 511 m below surface.

Table 16-13 Trident Acoustic Emission Method testing results

Depth Below Surface (m)	Principal Stress	Magnitude (MPa)	Bearing (°)	Plunge (°)
411m	Major	35	023	10
	Intermediate	22	292	05
	Minor	11	177	79
511m	Major	43	217	01
	Intermediate	29	127	16
	Minor	15	310	74

The Acoustic Emission results for Trident are in reasonable agreement with stress versus depth relationships determined for other Yilgarn Block Mines. For the geotechnical assessment of Chalice, it is expected that the maximum principal stress will be approximately 2.5 times overburden stress.

A summary of the first and fourth quartile Q-Values calculated for individual domain geometries and respective Q-System rock class rating are presented in Table 16-14.

Table 16-14 Chalice domain Q System Rock Class Rating results

Domain	1 st Quartile Q-Value	4 th Quartile Q-Value	Rock Class Range
HW	35.6	100.0	<i>Good – Very Good</i>
HW5	37.5	75.0	<i>Good – Very Good</i>
Ore	18.7	100.0	<i>Fair – Very Good</i>
FW5	34.3	100.0	<i>Good – Very Good</i>
FW	36.2	100.0	<i>Good – Very Good</i>

The key findings of the above Chalice feasibility study empirical assessment were that:

- The decline and ore access development can be expected to be undertaken primarily within good to very good quality amphibolite and felsic intrusive rocks; and
- The orebody ground conditions are assessed to be generally fair to very good.

16.2.1.5 Geology

The Chalice area of the HGO is situated between the gold mining centres of Norseman and St Ives. It lies to the west of the Zuleika Shear, towards the southern end of the Norseman-Wiluna Greenstone Belt of the Archaean Yilgarn Craton.

The greenstone package is north to northwest trending and is comprised of a lower mafic-ultramafic sequence overlain by felsic volcanic and volcanoclastic rocks. Numerous granitoid bodies either border or intrude upon this sequence. The metamorphic grade of the terrane ranges from lower greenschist facies in the central low-strain section of the belt, to mid and upper amphibolite facies along the western margin.

Chalice is located within a sequence of alternating mafic and ultramafic rocks flanked on the west by calc-alkaline granitic rocks and to the east by the Pioneer Dome Batholith. The mafic-ultramafic rocks comprise upper green schist to middle amphibolite facies metamorphosed high magnesium basalt, minor komatiite units and interflow clastic sedimentary rocks intruded by a complex network of multi-generational granite, pegmatite and porphyry bodies. This stratigraphic sequence has been affected by several regional deformation events.

The local geology is characterised by NNW-striking and west-dipping intercalated mafic and ultramafic volcanic rocks that are metamorphosed to mid-amphibolite facies grade (Figure 16-9 and Figure 16-10). This sequence is bounded to the west and east by thick granitic bodies of the Boorabin Batholith and Pioneer Dome Batholith, respectively. Intruding the 'greenstone' sequence is a complex network of multi-generational granite, pegmatite and porphyry bodies. The dominant unit that hosts gold mineralisation is a fine grained, weakly to strongly foliated amphibole-plagioclase amphibolite. Two major and one minor ultramafic units occur as discontinuous members throughout the deposit. The ultramafics generally consist of chlorite, tremolite and minor serpentine and are generally much more competent than the talc-chlorite ultramafic that is prevalent at Trident. At least four generations of granitic dike intrude the lithostratigraphic sequence and vary in morphology and orientation.

Figure 16-9 Chalice local geology as evident in the open pit

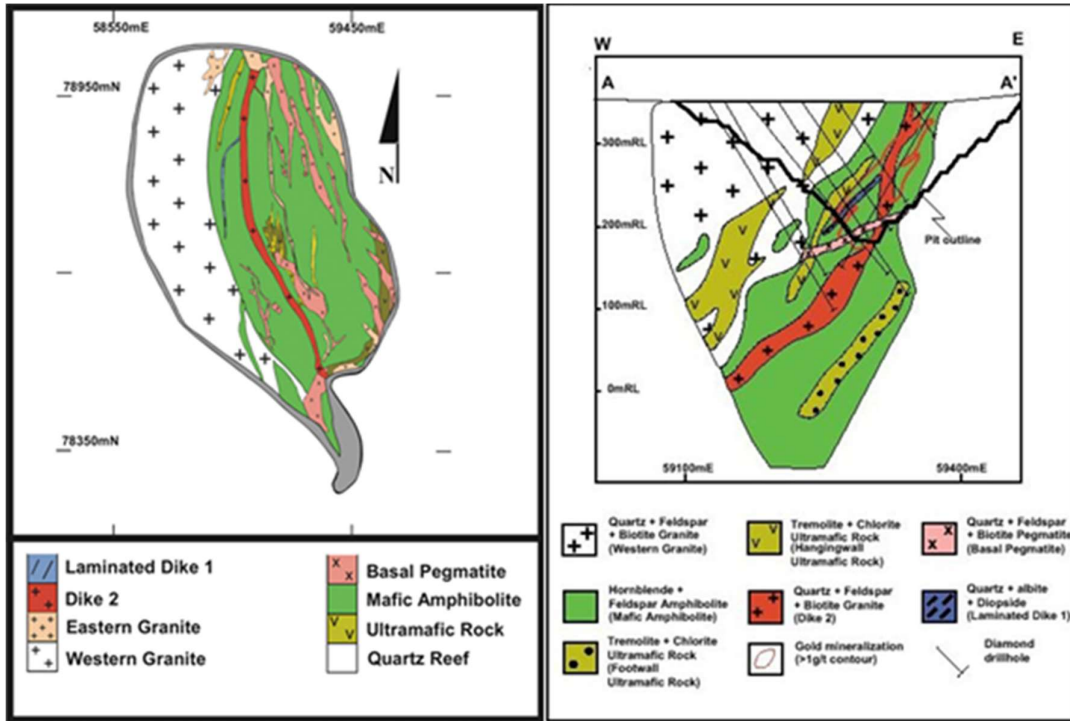

Figure 16-10 North wall of the Chalice pit showing the three main lithological zones, granite, ultramafic and amphibolite, along with various intrusive



The mineralisation at Chalice is characterised by strong diopside-hornblende-albite alteration with associated pyrite/pyrrhotite sulphides. Mineralisation occurs with highly foliated and folded host rock with width varying up to 50 m. The mineralisation at Chalice is not always visually distinct. Mineralised zones in the amphibolite of the main lodes (Kronos, Atlas, Grampians and Olympus) are generally identified by increased diopside-sulphide selvage-like veins, which usually have some amount of albite, +/-carbonate, silica and accessory minerals incorporated within them. Few quartz veins are present; instead, veins will often have a mix of silica and diopside. The amphibolite itself varies from unaltered to strong diopside, biotite and chlorite alteration +/- garnet, epidote, carbonate, albite and silica. At times significant silica alteration is associated with the amphibolite, which is not unusual to see near some of the larger barren quartz veins that are sometimes intersected. Silica flooding is also often observed well into the footwall of the main mineralised domains indicating alteration is far broader than the areas of higher grade mineralisation.

Small scale folding/crumpling of these veins and immediate host has also occurred, which gives the veins a 'swirly' characteristic about them. Sulphides in these areas tend to be increased from 3% to 12%, the more the rock has been deformed and altered, the greater the coincidence with gold mineralisation. However, not all of the grade intersected lies within these zones nor do these zones always return high grade, which in turn emphasises the importance of the 'shoot' control. Similarly, free gold has been seen in amphibolite zones that have few diopside veins, minor to moderate alteration, no apparent folding and are away from the main understood mineralisation trend.

Approximately 95% of the high grade mineralisation is mafic-hosted and conformable to the NNW striking, west dipping foliation. This mineralisation comprises two following forms:

- Selvage-like veins (1 cm to 30 cm) that are gold-bearing and parallel to the primary foliation. These contain quartz, albite, diopside, titanite, pyrrhotite, pyrite, chalcopyrite, magnetite (+trace scheelite, pyrite, magnetite, chalcopyrite, calcite and apatite); and
- Pervasive wall rock alteration that are characterised by quartz, albite, diopside, titanate, pyrrhotite, (+/-garnet, hornblende, biotite, calcite, apatite, scheelite).

The remaining 5% of the high grade mineralisation (second stage) comprises both the following:

- Selvage type veins that are gold bearing but discordant to foliation; and
- Disseminated gold, particularly at contacts, in an early felsic intrusive dyke.

These variably carry grade and are found within the confines of the amphibolite.

16.2.1.6 Historical Mining

The underground mining method at Chalice is predominantly sublevel open stoping and bench stoping. The Atlas and Olympus orebodies are steeply dipping, wide in geometry, host rock is very competent and sublevel open stoping is the most suitable. The Grampians orebody is different in geometry to the Olympus and Atlas orebodies and is a series of narrow vein stacked lenses. Bench stoping is used to mine these lenses.

Access to Chalice Underground is via a portal in the pit and decline. The decline profile down to 1200 level was initially mined by Resolute as an in-wall ramp and is 6.5 m wide and 7.0 m high at a gradient of 1 in 7.

Under the initial ownership of Alacer, both footwall and hangingwall drives were used to drill and extract large open stopes which can be seen in the extraction of Atlas mining area. As Alacer

looked to divest its Australian assets, the extraction standards changed to driving centrally through the orebody and thereby reducing the amount of development and costs.

Stope designs involved using either longhole rises or box holing for slot rising in stopes. Downhole drill design was the preferred option for ease of charging and separation of charging and bogging activities. After the extraction of stopes, no paste or backfilled was used to fill these voids. This posed minimal issues while extracting Atlas and Grampian orebodies. The main geotechnical issues associated with extracting numerous with no backfill was encountered on the Olympus mining area, particularly on the OLY 960, 930 and 900 levels. The unstable hangingwall in this area resulted in a significant dilution during stope extraction and posed safety issues.

16.2.1.7 Mine Design Parameters

Table 16-15 shows the typical mine design criteria for Chalice.

Table 16-15 Design criteria

Description	LHOS (20 to 25m vertical level spacing)
Minimum Stope width	4.5m (true width)-Target
Target ore zone for drilling	2m (true width)
Planned dilution (total) – included in minimum stope width	2m
Strike length (per stope or cut)	15m
Vertical Level Spacing	20m to 25m
Estimated Stope Dip Lengths	+24m to 28m
Maximum stope width	10m
Minimum dip (stopping area)	42°
Maximum dip (stopping area)	N/A
Unplanned dilution	0.5m
Final Stope width (evaluation)-Planned + unplanned overbreak - (true width)	4.5m
Minimum intact rock pillar between footwall and Hangingwall lodes	6m

The mine designs were loaded into Deswik software. Figure 16-11 and Figure 16-12 depict the design concluded for Chalice.

Figure 16-11 Chalice Mineral Reserves showing existing pit and workings looking west

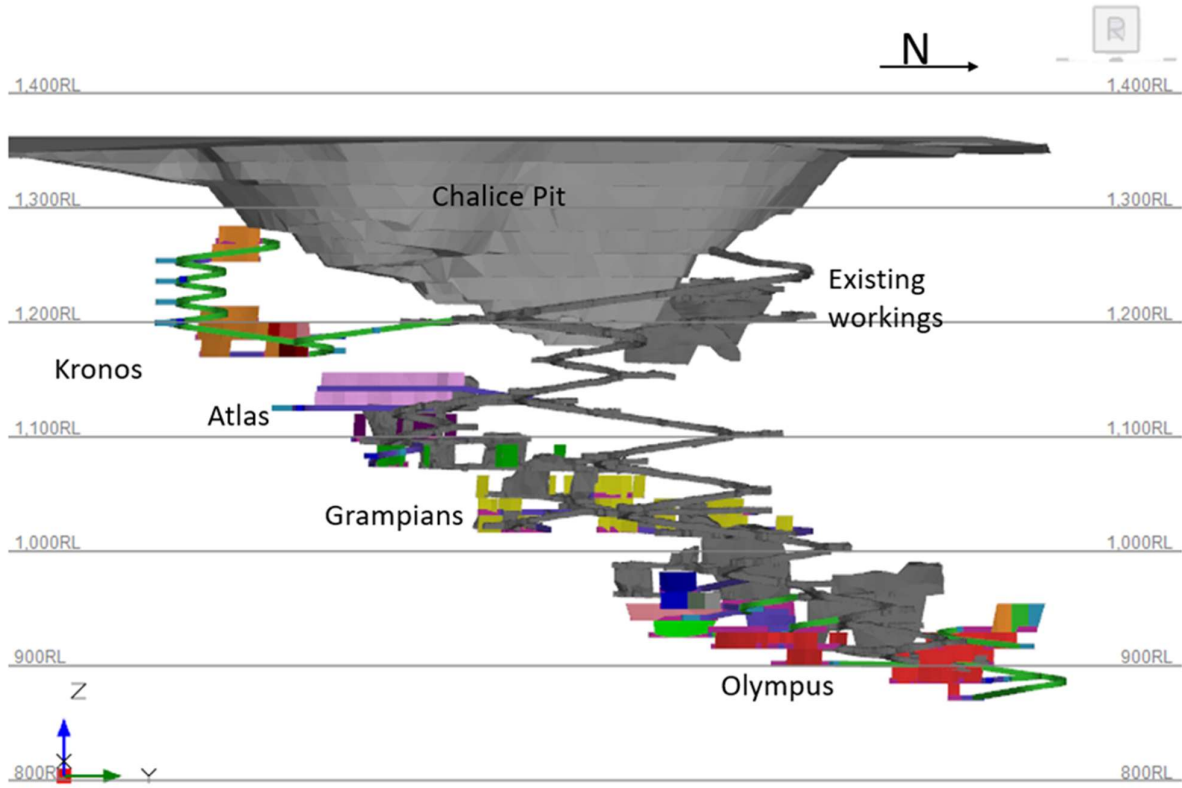

Figure 16-12 Chalice Mineral Reserves showing existing pit and workings looking north

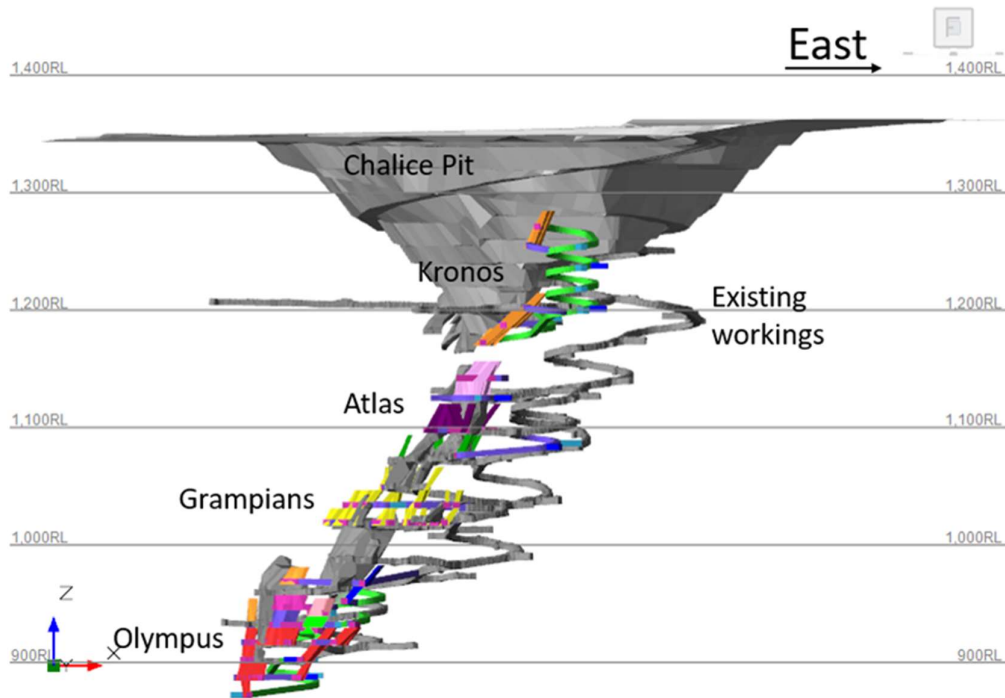
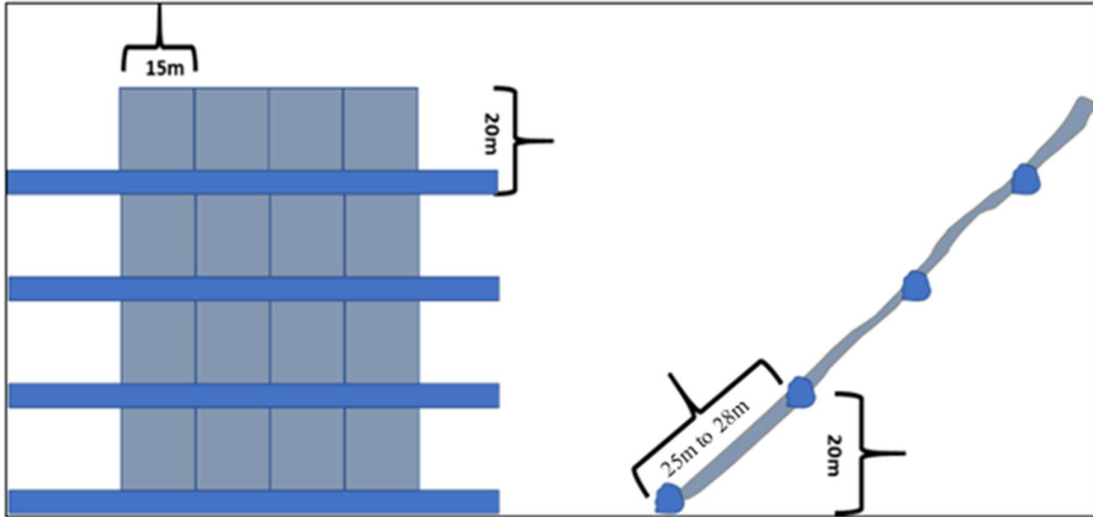

Figure 16-13 depicts the schematic layouts for the designed mining/stopping method.

Figure 16-13 LHOS design layout



16.2.1.8 Mine Scheduling

The mining schedule for the LOM plan was generated using Deswik mine planning software. Once the development and stope designs are produced, they are evaluated in Deswik against the geological block model. Development and stope shapes are then reviewed and included in the schedule if they are economic to mine. All activities that make up the stoping cycle, such as production drilling, charging and bogging are added into the mine schedule. The development and stoping activities are then linked in a logical extraction sequence which considers mining practicality, geotechnical and productivity constraints. Each task has an equipment resource applied to it, with schedule productivities based on current site performance and parameters appropriate to the equipment being used.

The current mine life is scheduled over 33 months (subject to further schedule refinements), as shown in Figure 16-14.

Figure 16-14 Chalice Underground schedule

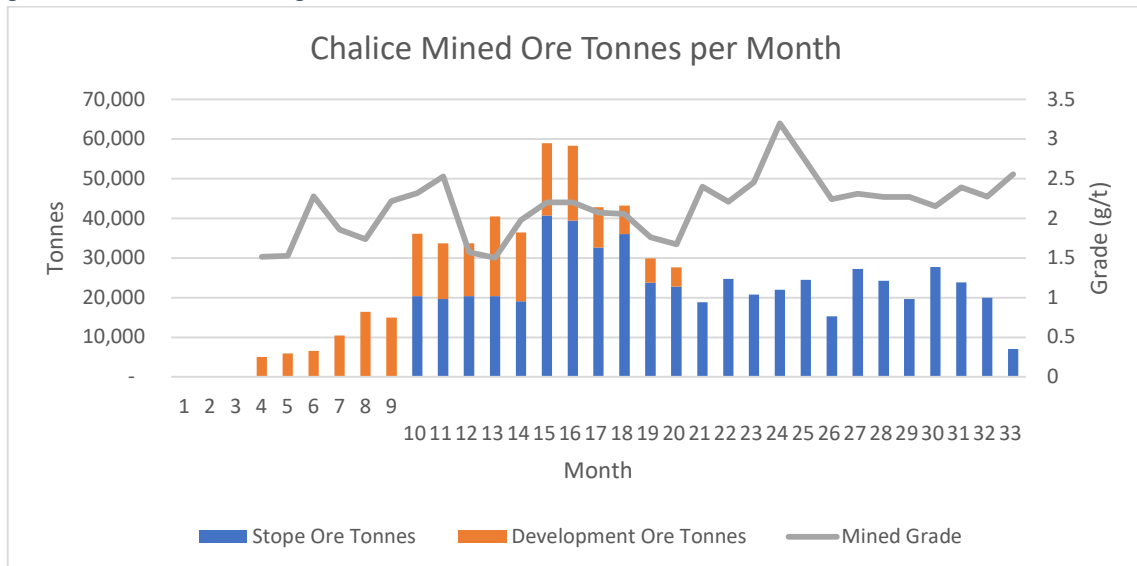

16.2.1.9 Mobile Equipment

The mine equipment proposed for Chalice is industry standard trackless underground diesel equipment constructed by reputable manufacturers and well suited to current site operations. The primary underground fleet is shown in Table 16-16.

Table 16-16 Primary underground fleet

Unit Description	Unit Quantity
Twin Boom Jumbo	1–2
Production Drill	1
10 t LHD	1–2
40 t Truck	1–2
Integrated Tool Carrier	1

16.2.1.10 Labour Estimate

The cost model simulated the following labour requirements for the scheduled production at Chalice as shown in Table 16-17.

Table 16-17 Labour requirements

Labour	Maximum	Year 1	Year 2	Year 3
Jumbo Operators	4	4	4	0
Charge-Up Operators	4	4	4	4
Long Hole Drill Operator	4	4	4	4
LHD Operators	7	5	7	4
Truck Operators	4	3	4	3
Grader Operators	4	4	4	4
Water Cart Operators	4	4	4	4
Serviceman	8	8	8	8
Storeman	3	3	3	3
Magazine Keeper	2	2	2	2
Nipper	3	3	3	3
Lead Hand Fitter	4	4	4	4
Fitters	4	4	4	3
Drill Fitter	1	1	1	1
Light Vehicle Fitter	2	2	2	2
Electricians	2	2	2	1
Project Manager	1	1	1	1
Mine Foreman	2	2	2	2
Shift Supervisor	3	3	3	3
Safety and Training Manager	1	1	1	1
Safety Trainer	1	1	1	1
Maintenance Foreman	1	1	1	1
Maintenance Senior Leading Hand	2	2	2	2
Electrical Supervisor	1	1	1	1

Labour	Maximum	Year 1	Year 2	Year 3
Alt. Electrical Supervisor	2	2	2	2
Site Administrator	2	2	2	2
Mining Engineer	1	1	1	1
Geologist	2	2	2	2
Total Labour	79	76	79	69

16.2.1.11 Site Layout

Chalice is a historical open pit and underground mine, but with good existing development drives and limited existing mining infrastructure. Additional surface mining infrastructure was planned and costed for this mine plan. The key infrastructure includes the following:

- Ramp access to underground mine (from the open pit) exists and is to be rehabilitated in parts.
- A surface workshop used for major maintenance and routine services for the mobile equipment fleet is to be constructed.
- A ventilation system that uses the decline and two additional ventilation rises exists. Additional ventilation fans are included in the cost estimate to re-equip the ventilation network at Chalice.
- A dewatering system will be re-established.
- Management and administration offices exist.

Utilities provided to the mine include:

- Power;
- Power cable and sub-station establishment;
- Piping and cable installations;
- Ventilation ducting;
- Surface workshop areas and wash bays; and
- Communication systems.

16.2.2 Spargos Underground

16.2.2.1 Underground Infrastructure

The main decline at Spargos is to be located to the east of the mined lodes. This location was selected due to high-sulphide zones in the host rock west of the lodes, representing potential acid-forming reactivity and sulphide-related hazards. The Spargos decline stand-off is ~40 m to 60 m from stoping activities to maximise long-term stability of capital infrastructure. Mine infrastructure systems such as primary mine ventilation and escapeways have been accounted for in the capital design. Decline stockpiles exist on the north and southern ends of the decline loops in order to provide locations to perform GC drilling, which is planned to be completed ahead of ore drive development. Sumps are planned on each level and line up above each other to provide drainage by means of service holes between sumps. Electrical reticulation will be via service holes drilled between each level escapeway drives. A primary pumping station is planned at 300 RL, (just below the interpreted Severn Fault) to keep the UG workings dewatered. There is an allowance for mono pump stations every 100 m vertical below the primary pump station. The underground pumping system is targeting a pumping capacity of

25 L/s to 30 L/s, which is a combination of Flygt pumps in sumps, travelling mono pumps and permanent pump stations both underground and in the Spargos Pit floor.

Spargos primary ventilation fans will be located underground in a bulkhead inside the exhaust portal. As a result of exhaust into the pit, some delays to mine re-entry may be experienced from recirculation of blasting fumes. Airflow diversion infrastructure or turbulence fans may be required at the ventilation portal to divert exhaust airflows upwards to reduce blasting fumes settling in the lower portions of the pit due to the limited footprint.

The ventilation portal will provide the second means of egress out of the Spargos mine by linking up to the internal escapeway system. The escapeway systems will be isolated from the main mine exhausts via a shotcrete wall and personnel access door near the main exhaust fans.

Return air rises (RARs) are designed to be 4.0 m x 4.0 m longhole rises, excavated by drill and blast methods. The rises are located in return air ways off of the decline and are offset each level. The RAR dimensions were chosen to reduce resistance, promoting lower power draw due to reducing primary fan operating pressure.

Short-circuiting of primary decline airflows through stopes will be of concern and will require management through use of parachutes to block off stope brows on levels above while mining and placement of permanent brattices or bulkheads at level accesses after completion of mining on a level. Leakages through these level bulkheads will be minimised through use of shotcrete or an alternative sealing method.

Escapeways for the Spargos mine are located internal to the level accesses. The escapeways drives are to be developed adjacent to internal stockpiles.

16.2.2.2 Mining Methods

The mining method for the Spargos underground mines is conventional top-down sublevel open stoping with rib pillars. This mining method was selected for the following reasons:

- The method is consistent with the orebody geometry and rock mass conditions.
- The method is common in the Goldfields and consistent with the local workforce's experience in mining narrow orebodies.
- The method is mechanised and affords the lowest production cost whilst maintaining good productivities.

Spargos has been designed to be extracted in a top-down sequence using 20 m floor-to-floor sublevel spacing. The moderate to steeply-dipping lodes (>75°) and the proposed ore drive height of 5 m result in stope production drill hole lengths in the range of 15 m to 16 m, which will allow for acceptable longhole drilling accuracy.

16.2.2.3 Geotechnical

No intact rock testing has been performed for the Spargos rock mass to date. Geotechnical logging of two diamond holes has identified that a majority of logged core was ranked as an R5, representing good to very good rock mass conditions.

Historical stopes mined in the 1940s daylighted into the mined open pit. It can be seen by studying these voids, that the stopes were large, unsupported spans and remained open with no noted fall-off or time dependant failure.

Major defect sets range from shallow to steeply-dipping localised foliation and veining to jointing, shears and minor faulting. Persistence of the defects was not able to be determined. One major,

flat-dipping fault (Severn Fault) has been identified running through the Spargos deposit. The major logged rock defects are shown in Table 16-18.

Table 16-18 Spargos rock defects

Defect Set	Defect Description	Dip/Dip Dir
1	Flat lying faults, shears, joints & veins	5°/255°
2	Foliation & associated sub-parallel shears, joints & veins	88°/285°
3	Veins & joints	40°/005°

The mining method selected for Spargos underground is sublevel open stoping with pillars. The long-term stability of the mine and the localized control of hangingwall and footwall failures is dependent on intact pillar strength. Experience in similar rock masses would suggest that full-height rib pillars of minimum strike length of 5 m should remain stable for the production life of the mine. Where orebody widths are in excess of 5 m, the rib pillar strike should be equal to the average stope width (orebody thickness). This will maintain a 1:1 cross-section (width to strike) ratio.

Sill pillars will be placed at intervals not exceeding 100 vertical metres (unless subsequent geotechnical modelling suggest otherwise) and should equal the stope width in pillar thickness to maintain a 1:1 cross-section (width to height) ratio. The objective of the sill pillar is to arrest the fall material from sequential weakening and localized failure of the hangingwall or footwall from progressive mining and blasting on levels down dip of existing exposures.

Sill and rib pillars were not explicitly designed in the stope shapes, but rather extraction ratios have been applied to the Spargos MSO stopes to allow for the tonnes that will remain in situ in rib and sill pillars. These extraction ratios are based on the nearby (18 km) Beta Hunt deposit stress fields and rock properties and vary with depth. For extra conservatism, these calculated extraction ratios were reduced by a further 5%.

A 22 m crown pillar has been designed between the existing open pit and the planned Spargos open stopes. A standoff of 10 m exists between the existing UG development and the planned Spargos stopes. These dimensions are considered to be conservative and, with further work, may be reduced prior to mining.

16.2.2.4 Geology

The Spargos gold deposit occurs within a sequence of meta-sedimentary and meta-volcaniclastic rocks in the western limb of a tight, southerly plunging synform. The strata dip at very high angle to the east, with existing stoping being almost vertical. Footwall (western) strata are composed of crystal and lapilli tuffs, which become increasingly altered to quartz-sericite schist along a major shear zone as they approach the contact with coarse-grained, biotitic greywacke in the hangingwall (east).

Gold mineralisation is stratiform, unlike most other gold deposits in the regions, and occurs in association with disseminated arsenopyrite at the base of greywacke sequence. The underlying footwall schist is strongly sericitised and pyritised nearby to the gold mineralisation. High groundwater inflows from the Severn Fault (see Section 16.2.25), is the main obstacle to mining of the deposit.

16.2.2.5 Hydrology

The Severn Fault was intersected in several winzes in the underground workings between the No. 3 and 4 Levels. Maps of the underground workings indicate that the fault was actually intersected at three closely-spaced levels, referred to as 'water channels' on account of their high groundwater inflows. Historical record indicated the Severn Fault produced around 17 L/s groundwater inflow. Except for the Severn Fault, some pegmatite dykes and possibly the cross-cutting faults, it would appear that the permeability of the Spargos deposit is very low.

A water sample taken from 126 m depth in a recent RC mineral exploration hole indicates that the groundwater has a salinity of about 9,200 mg/L TDS (total dissolved solids).

It is possible that groundwater inflows when mining Spargos underground will be greater than permitted to discharge under the current Premises License arrangement. A new mining proposal and closure plan is in progress to gain approval from DMIRS to build a dewatering pipeline to Lake Lefroy (near Beta Hunt), and discharge the Spargos water under the Beta Hunt Premises License.

The critical items for completion to lodge the mining proposal include the following:

- Legal access to the land and third-party infrastructure via miscellaneous licenses and access agreements (currently ongoing);
- Approved Conservation Management Plan with Department of Biodiversity, Conservations and Attractions for the Kambalda Timber Reserve;
- WA Water Corporation approval to cross pipeline at Caves Rocks; and
- Amend tenement conditions to gain Ministerial Approval for pipeline in Water and Timber Reserves.

Miscellaneous Leases hosting the dewatering pipeline from Spargos to Beta Hunt, L15/434, L/435, L15/437, L15/438, L15/445, L15/446, L15/447 and L15/448 are currently awaiting approval pending successful third party access agreement negotiations.

Beta Hunt will require a Premises Licence amendment to increase the dewatering allowance to Lake Lefroy up to 1.2 GL/a with the Spargos discharge. An ecological assessment of the combined impacts to Lake Lefroy from mining operations is due for completion in early 2024 to support the application for the Premises License amendment.

It is the opinion of the QP that it can reasonably be assumed that Karora will gain these approvals prior to the commencement of mining of the Spargos Mineral Reserve.

A flood protection bund will be placed across the main pit ramp to divert surface run-off away from the pit ramp.

16.2.2.6 Historical Mining

The Spargos Deposit was initially mined as an underground operation which ceased in 1942 owing to high water inflows from the Severn Fault and a lack of labour during the Second World War. Queen Margaret Gold mines re-accessed the underground workings in 1981 for mapping and drilling, and the deposit was then mined by Amalg Resources NL in 1989-1991 as a shallow pit.

Karora commenced mining at Spargos in January 2022 and completed the Stage 2 Pit to a depth of 85 m (325 mRL) in November 2022.

16.2.2.7 Mine Design Parameters

Table 16-19 shows the stope design parameters for Spargos.

Table 16-19 Spargos stope design parameters

Description	LHOS (20m vertical level spacing)
Minimum Stope width	2.5m (true width)-Target
Target ore zone for drilling	1.5m (true width)
Planned dilution (total) – included in minimum stope width	0.5m
Strike length (per stope or cut)	15m
Vertical level spacing	20m
Estimated stope dip lengths	+20m to 22m
Maximum stope width	20m
Minimum dip (stopping area)	45o
Maximum dip (stopping area)	N/A
Unplanned dilution	0.5m
Final Stope width (evaluation)-planned + unplanned overbreak - (true width)	2.5m
Minimum intact rock pillar between footwall and hangingwall lodes	10m

Using the results of likely drilling deviation and/or drill and blast performance, a dilution ‘skin’ has been assumed of 0.25m on the hangingwall (HW) and footwall (FW). The resulting dilution percentages for different minimum mining widths (MMW) were estimated and checked against past stope performance in similar geometric and geologic environments. The MMW is the minimum design width (MDW) + 0.25 m HW and FW dilution skin. The stope dilution percentages are shown in Table 16-20.

Table 16-20 Estimated dilution percentage as a function of MDW and 0.25 m HW and FW overbreak.

MDW (m)	MMW (m)	% Dilution
1.5	2.0	33%
2.0	2.5	25%
2.5	3.0	20%
3.0	3.5	17%
3.5	4.0	14%
4.0	4.5	13%

Experience with narrow vein mining in competent rock masses suggests that 33% dilution at the minimum design width of 1.5 m is an achievable result and thus an acceptable assumption for stope designs at Spargos.

The mine designs were developed in Deswik software. Figure 16-15 and Figure 16-16 depict the design concluded for Spargos.

Figure 16-15 Spargos Underground Mineral Reserve design with existing pit (gray) and historical workings (black) looking west

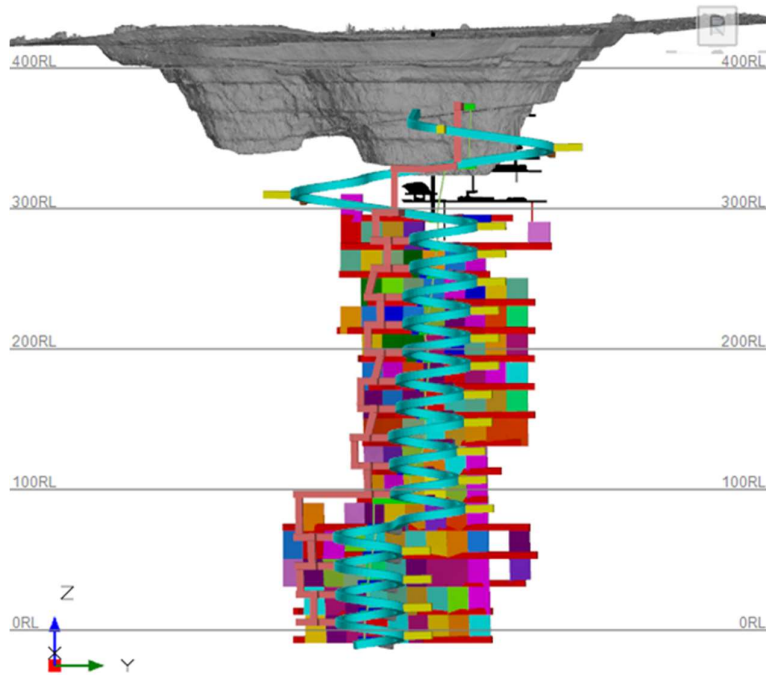
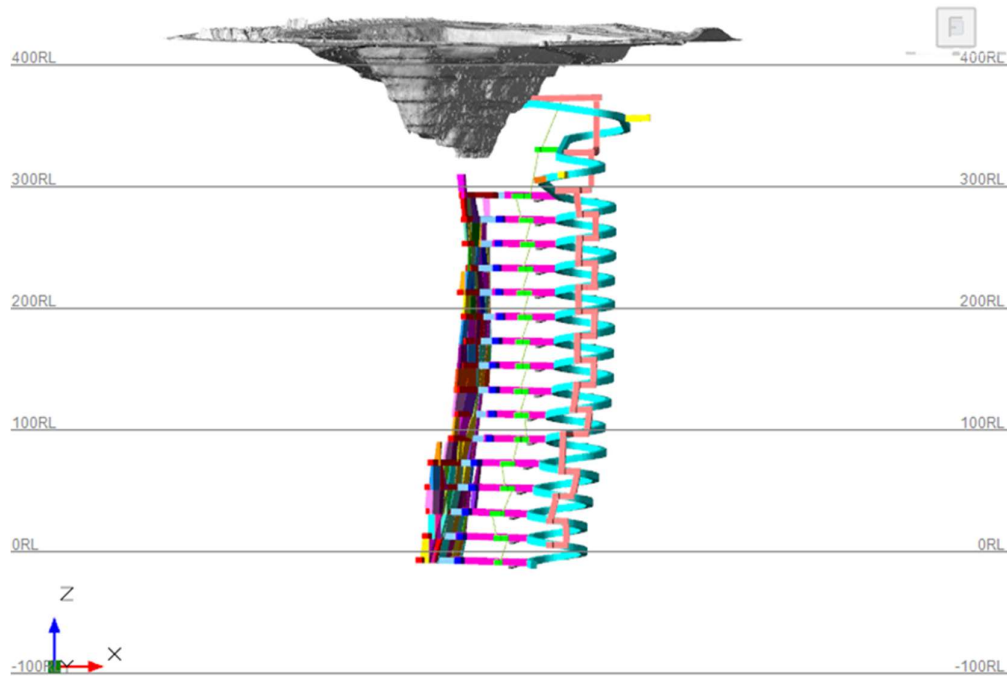

Figure 16-16 Spargos Underground Mineral Reserve design with existing pit (gray) looking north



16.2.2.8 Mine Scheduling

The mining schedule for the LOM plan was generated using Deswik mine planning software. Once the development and stope designs are produced, they are evaluated in Deswik against the geological block model. Development and stope shapes are then reviewed and included in the schedule if they are economic to mine. All activities that make up the stoping cycle, such as production drilling, charging and bogging are added into the mine schedule. The development and stoping activities are then linked in a logical extraction sequence which considers mining practicality, geotechnical and productivity constraints. Each task has an equipment resource applied to it, with schedule productivities based on current site performance and parameters appropriate to the equipment being used.

The current mine life is scheduled over 34 months (subject to further schedule refinements), as shown in Figure 16-17.

Figure 16-17 Spargos mined ore tonnes and grade

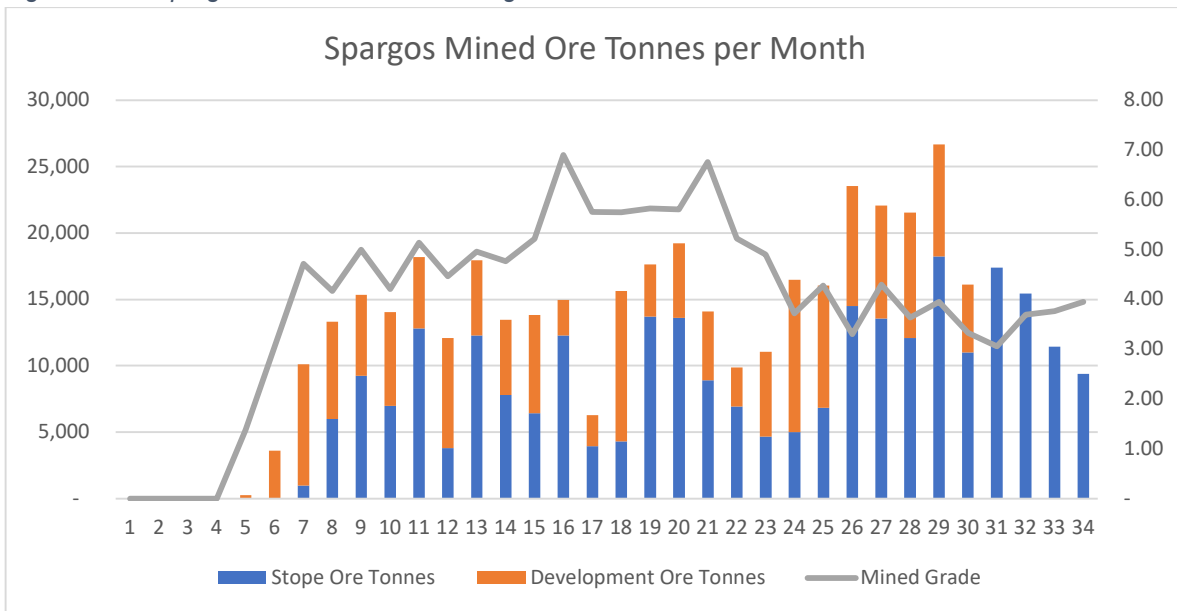

The Spargos Mine Schedule is particularly sensitive to lateral development rates, as production rates will be determined by how quickly the decline can be advanced to uncover new working levels. The development schedule for the Spargos Mineral Reserves plan is shown in Figure 16-18.

Figure 16-18 Spargos planned lateral development per month

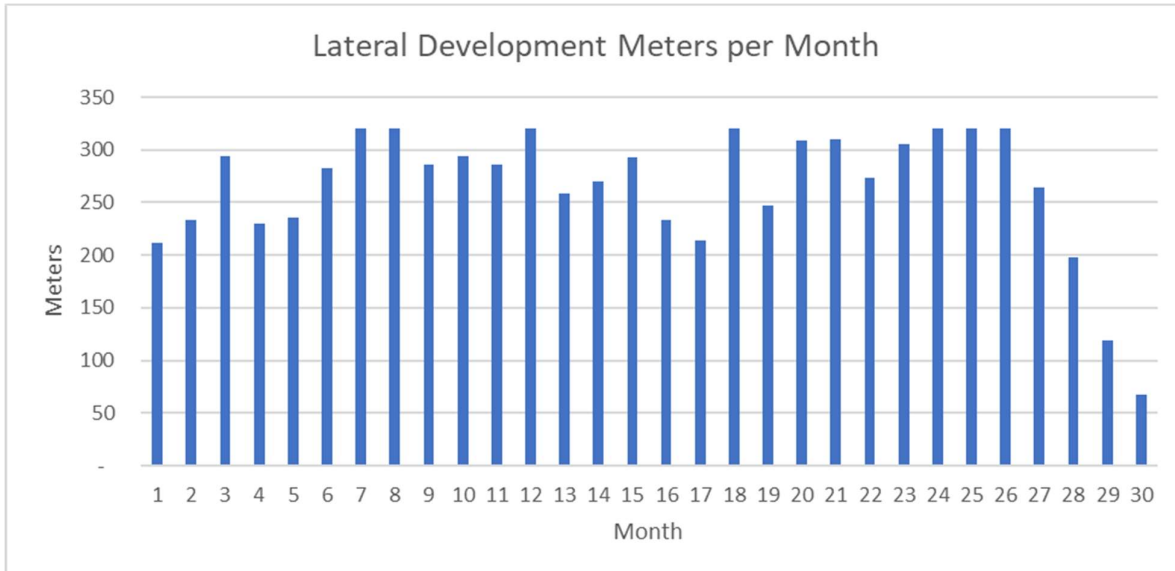

16.2.2.9 Mobile Equipment

The mine equipment proposed for Spargos is industry standard trackless underground diesel equipment constructed by reputed manufacturers and well suited to current site operations. The primary underground fleet is shown in Table 16-21.

Table 16-21 Primary underground fleet

Unit Description	Unit Quantity
Twin Boom Jumbo	1
Production Drill	1
10 t LHD	1-2
40 t Truck	1-2
Integrated Tool Carrier	2

16.2.2.10 Labour Estimate

The cost model simulated the labour requirements for the scheduled production at Spargos as shown in Table 16-22.

Table 16-22 Labour estimate

Labour	Maximum	Year 1	Year 2	Year 3
Diesel Crew	31	23	31	24
UG Management & Supervision	6	6	6	5
Site Management	2	2	2	2
Technical Services AU	5	5	5	4
Training & HS	3	2	3	2
Electrical Maintenance	3	3	3	2
Mobile Maintenance	12	12	12	10
Diamond Drilling	3	2	3	0
Total	64	55	64	49

16.2.2.11 Site Layout

The previous Spargos infrastructure area will be utilised for workshop, mine contractors' facilities and the Karora technical and administrative facilities.

Ore will be hauled by mine trucks to the current Spargos ROM pad from where it will be rehandled to road trucks for transport to the Higginsville or Lakewood Mills which are equidistant to Spargos.

16.2.3 Mt Henry Project

The MHP consists of the Mt Henry, Selene, North Scotia and Abottshall areas. A mine plan and associated Mineral Reserve has been developed for Mt Henry, Selene and North Scotia. Abottshall was not assessed as it comprises Inferred Mineral Resources only and therefore cannot be considered for conversion to a Mineral Reserve. The mine plan developed for this study has been developed to a prefeasibility study (PFS) level of confidence and can therefore be considered to reflect a level of accuracy of 20% to 25%.

The Mt Henry deposit lies approximately 23 km south of Norseman, Western Australia, with the HGO and associated mill lying a further 60 km north of Norseman. There is an existing open pit at Mt Henry that extends for a length of approximately 1.4 km and to a depth of 80 m below surface. A waste dump was developed approximately 100 m to the west of the pit and extends to a maximum height of approximately 30 m above surface. There is also a small satellite pit (~175 m in length) to the north of the main pit with its own smaller waste dump approximately 350 m to the west of this pit. The site is connected to the Coolgardie-Esperance Hwy via 2 km of unsealed road. There is an existing ore stockpile area and access roads.

Selene and North Scotia are greenfields projects that lie 3.5 km and 5.6 km, respectively, further south of Mt Henry. The current overall layout is shown in Figure 16-19.

Figure 16-19 Mt Henry Group current layout

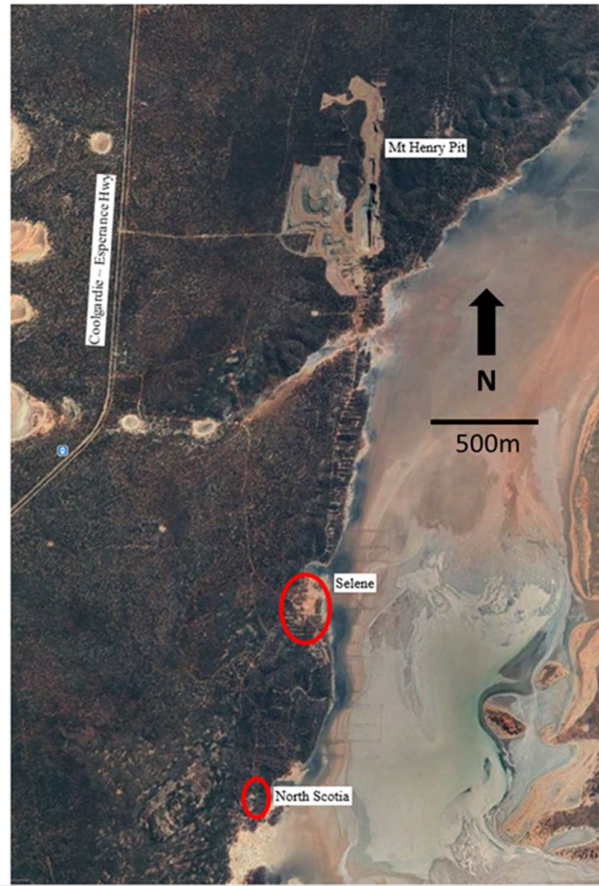

16.2.3.1 Open Pit Mining Infrastructure

As these open pits are routine drill, blast, load and haul operations, located close to the Higginsville Mill, no additional mining infrastructure will be required. As part of the mining costs and contractor costs, equipment parking areas and small/fit-for-purpose maintenance areas will be allocated for Selene and North Scotia. The previous Mt Henry infrastructure area will be utilised for workshop, mine contractors' facilities and the Karora technical and administrative facilities. Housing of mining contractors is possible within the town of Norseman for the MHP which is located 83 km from the Higginsville camp and only 23 km from Norseman township.

16.2.3.2 Mining Methods

The MHP mining study adopted a conventional truck and shovel open pit mining method as the preferred mining method due to the following reasons:

- The method is typical for the commodity and utilises established technologies proven at other locations throughout region.
- The ore presentation is sufficiently close to surface.
- There is space to build waste dumps.
- It will generate the best project value with the greatest likelihood of success.

The study assumes that all mining related operations will be undertaken by a suitably qualified and experienced mining contractor, including the following:

- Mobilisation and demobilisation of equipment and consumables;
- Maintenance and operation of all equipment necessary for undertaking the works;
- Provision of all personnel for the works;
- Construction and ongoing maintenance of the contractor's infrastructure;
- Clearing and grubbing of pit, dump and road areas; topsoil will be segregated and stockpiled separately, to be used for subsequent progressive rehabilitation activities;
- Construction and maintenance of all haul roads used primarily by the contractor;
- Drill and blast, including presplit drilling as necessary;
- Excavate, load, haul and dump of all materials to the designated destinations;
- Stockpiling and dumping of all materials as required;
- Rehandle of stockpiled ore to road trucks for transport to the Higginsville Mill;
- Provide and control surface drainage;
- Manage water within the open pit area and associated surface activities, including removal of stormwater and groundwater; and
- Progressive rehabilitation work.

Karora will be responsible for mine design, mine planning, grade control, survey, statutory safety and environmental compliance and to carefully supervise and manage the mining contractor. As such, Karora will have its own supervisory and technical team.

The mining already undertaken at Mt Henry by previous owners indicated the following:

- Benches were mined as free dig where possible whilst drill and blast was utilised once hard rock was encountered; and
- The ore in all pits is shallow-dipping in the supergene enrichment progressing to sub-vertical, steeply-dipping lodes within the main BIF unit located in the transitional/fresh material. The nature of the lodes at depth allowed the ore blocks to be faced up with ease when mining.

The current mine plan assumes the following:

- The mining of the ore zone is planned at a nominal 5 m bench height using a back-hoe excavator mining on two 2.5 m flitches. This will facilitate selective mining between ROM grade ore, potential low-grade ore and waste boundaries.
- Waste will be blasted on 10 m benches where possible, typically in continuous waste zones from the HW of the pit to the HW edge of the ore zone.
- Grade control will be based on an advanced RC grade control program in 20 m to 30 m vertical campaigns across the various working areas.
- Wherever possible, blasting will consist of either separate waste and ore blasts to free faces parallel to the deposit, or the ore will be chock blasted within the waste zones to minimise excessive dilution of ore or loss of ore to waste.

16.2.3.3 Hydrology

Groundwater salinity of the Mt Henry pit ranges from 10,000 mg/L TDS in the north to 121,000 mg/L TDS in the south. Higher salinity is considered to be representative of the ambient groundwater quality in the crystalline bedrock. Due to the proximity to Lake Dundas, Selene Pit groundwater is hypersaline at 251,000 mg/L TDS and North Scotia Pit groundwater salinity ranges from 239,000 mg/L TDS to 274,000 mg/L TDS.

Numerical modelling indicates that inflows to the three pits will range from 5.5 L/s (173,448 kL/a) to 8.3 L/s (261,749 kL/a). Due to the presence of a thick alluvial sequence in Selene Pit, there is

a possibility of increased groundwater inflows of up to 10 L/s (315,360 kL/a) during significant rainfall events.

All dewatering discharge will be transferred to a process water dam at the surface for use by the operation for dust suppression. At the predicted dewatering rates, there should be no requirement to discharge mine water to the environment.

Surface water ditches, culverts and bund walls in places around the planned pits will be designed to divert surface water runoff away from the open pit operations (as far as practicable). These designs will be informed by hydrogeological modelling.

16.2.3.4 Geotechnical

A number of geotechnical studies and assessments have been carried out at various times by previous owners of the MHP deposits. The parameters utilised by Entech to develop both the GEOVIA Whittle™ optimisation overall slopes and the design criteria were sourced from geotechnical assessments undertaken by independent geotechnical consultants Peter O'Bryan and Associates for Panoramic. The recommended slopes are detailed in Table 16-23.

Table 16-23 Selene and North Scotia recommended slope angles

Zone	Face Height	Face Angle	Berm Width	Inter-ramp Angle	Stack Height	Stack Berm Width
Selene						
East Wall (Footwall)	10	55	10	31	N/A	
Other Walls - Surface to 250mRL	10	55	5	39.8	80	15
Other Walls - <250mRL	20	70	7	54.5	80	15
North Scotia						
Surface to 10m	10	50	5	36.8	80	15
>10m depth	20	70	7	54.5	80	15

The Mt Henry slopes parameters were sourced from a subsequent update 'Mt Henry Gold Project – Open Pit Design Review No.2' (Peter O'Bryan & Associates, 2015). These recommended slopes are detailed in Table 16-24.

Table 16-24 Mt Henry recommended slope angles

Zone	Face Height	Face Angle	Berm Width'	Inter-ramp Angle	Stack Height	Stack Berm Width
Mt Henry						
East Wall (Footwall) - Surface to 270mRL	20	65	8	49		
East Wall (Footwall) - <270mRL	20	75	8	56.3	At 270RL	15
Other Walls	20	75	8	56.3		

These parameters were adopted with the following provisions:

- Open pit excavation is undertaken to a consistently high standard. It is expected that considerable effort in drill and blast and limiting excavation will be required to achieve sound final walls. In particular, application of consistently effective perimeter blasting methods is expected to be pivotal to successful wall management.

- Equipment and supplies for installation of rock fall protection measures are readily available and are instigated promptly when needs are identified.
- Slope monitoring and inspection is undertaken to a consistently high standard to confirm the applicability of the slope design and, if required, provide input into slope design modifications.

Allowances for ramps were made in the development of the overall slopes used in the optimisation process.

16.2.3.5 Historical Mining

Historical mining activity occurred at Mt Henry between 2016 and 2019 by previous owner Metals X, resulting in an abandoned open pit. Selene and North Scotia are both greenfields mining areas. Karora obtained the MHP tenements as part of the HGO acquisition in June 2019. Total mine production is 2.3 Mt @ 1.7 g/t for 127 koz (contained). Prior to Westgold, Australis Mining NL mined 112 kt @ 1.1 g/t from the Mt Henry Pit 2 area in the 1980s.

16.2.3.6 Mine Design Parameters

Table 16-25 depicts the typical pit design criteria for each of the open pits.

Table 16-25 Mt Henry Project mine design parameters

Description	Mt Henry	Nth Scotia	Selene
Bench Height m	20	10–20	10–20
Typical Face Angles (Oxides)	65°–75°	50°	55°
Typical Face Angles (Transition Rock)	75°	70°	55°
Typical Face Angles (Fresh Rock)	75°	70°	70°
Typical Berm Width (Oxides) m	8	5	10
Typical Berm Width (Transition Rock) m	8	7	7
Typical Berm Width (Fresh Rock) m	8	7	7
Overall Slope Angles (Ranges)	46°–56°	41°–50°	24°–54°
Ramp Width m (Single Lane– Dual Lane)	17–25	15	17–25
Ramp Inclination %	10	9	10
Pit Depth (max) m	130	55	145

The mine designs were developed by Entech. Figure 16-20 to Figure 16-23 depict the pit designs for the Mt Henry Project open pit deposits.

Figure 16-20 Mt Henry Mineral Reserve pit design

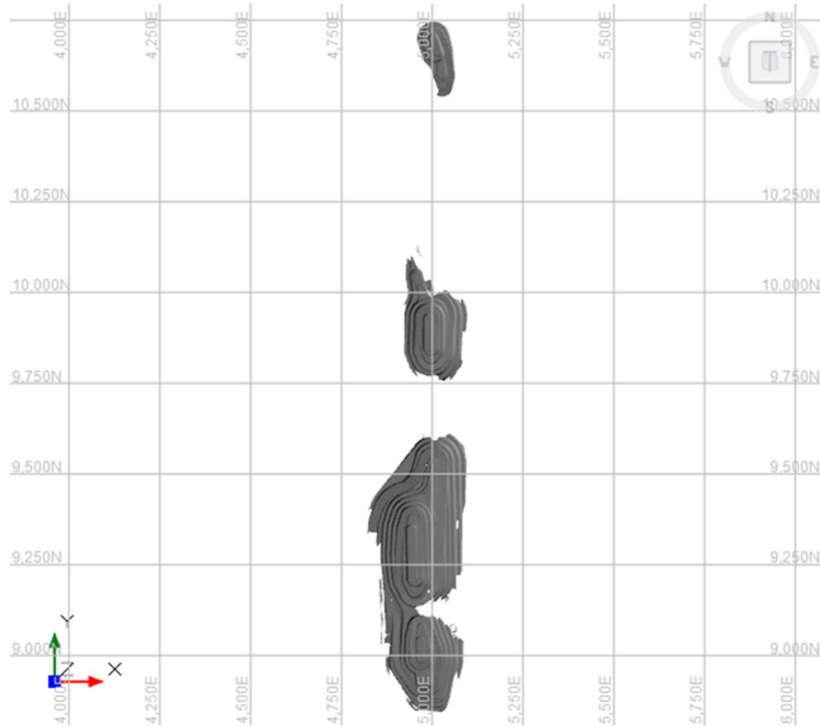

Figure 16-21 Mt Henry Mineral Reserve design (purple) and current pit as-built

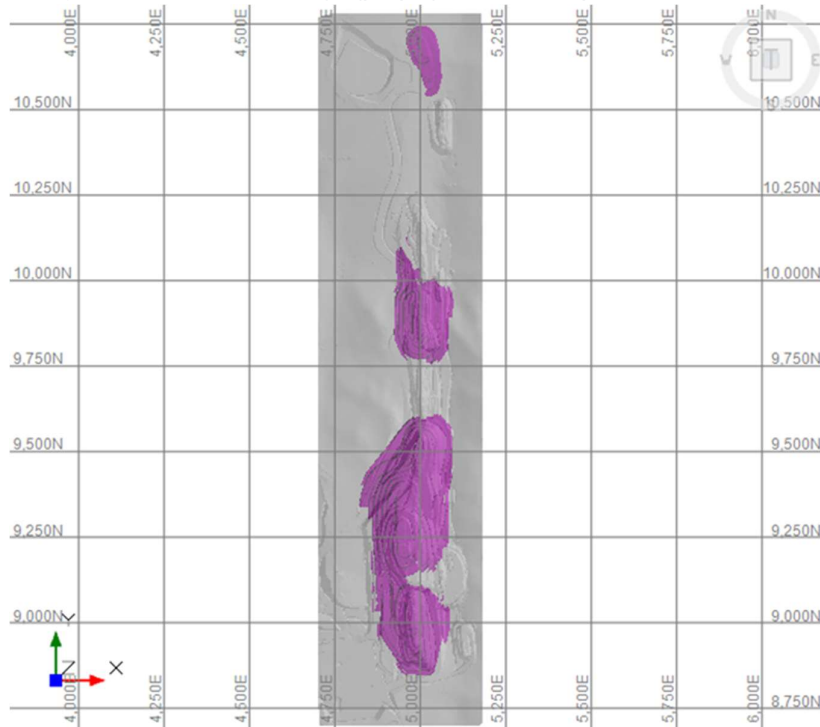

Figure 16-22 North Scotia Mineral Reserves pit design

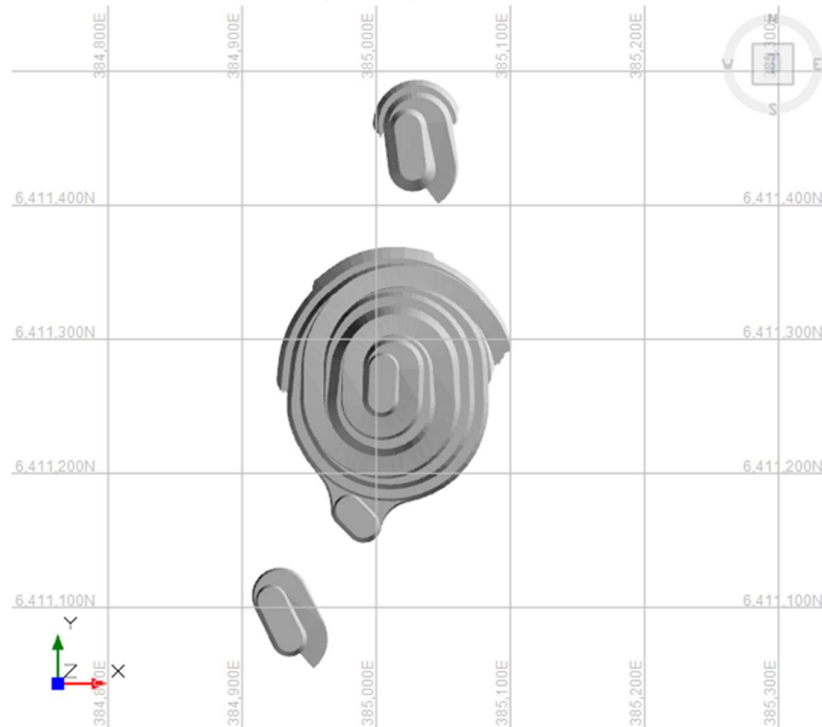
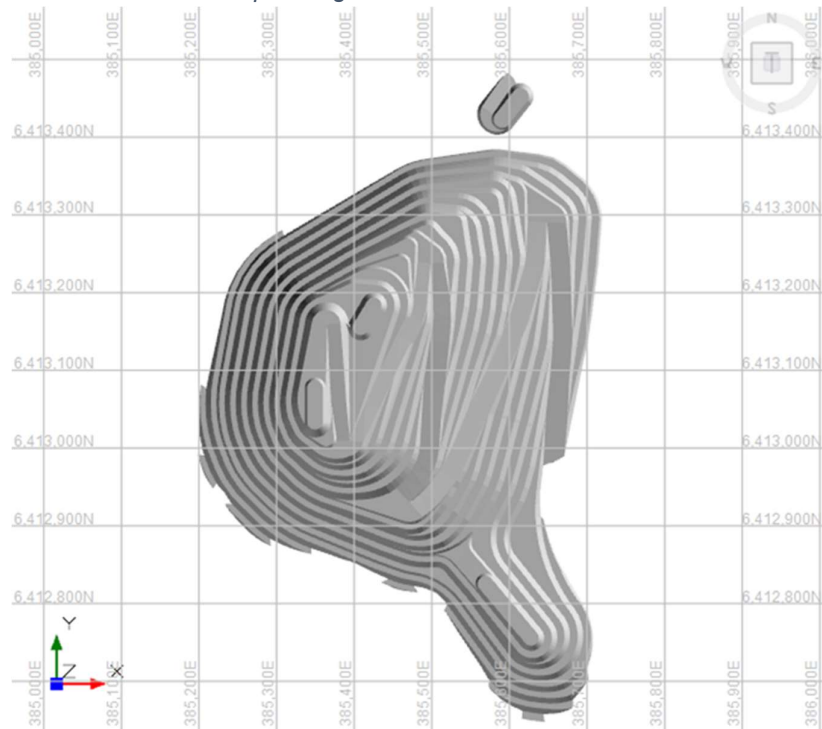

Figure 16-23 Selene Mineral Reserve pit design



16.2.3.7 Mine Scheduling

A mine schedule inclusive of the three deposits was completed with the following assumptions:

- Process plant throughput rate of 1.6 Mtpa; MHP ore is only treated at Higginsville Mill.
- No constraints were applied to the sequencing of the different areas.
- Operating fleet of ~140 t class excavator, with three excavators required early in the schedule, reducing as the strip ratio of each pit reduces, to one 100 t excavator operating on dayshift only.
- The following graphs and tables summarise the schedule physicals accumulated into months.

The schedule allows for a ROM stockpile of approximately 300 kt to 500 kt to be maintained.

The total schedule consists of 83 months of mining and 86 months of milling, shown in Table 16-26.

Figure 16-24 Mt Henry Project – mined tonnes

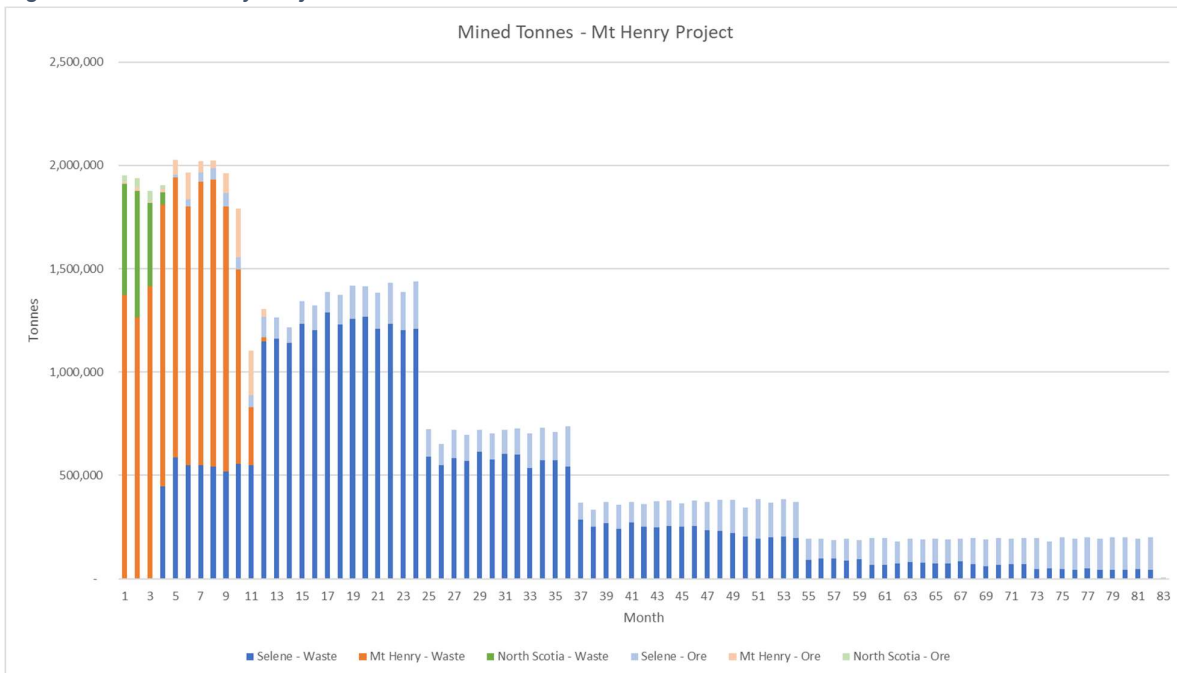

Figure 16-25 Mt Henry Project – mined ore tonnes

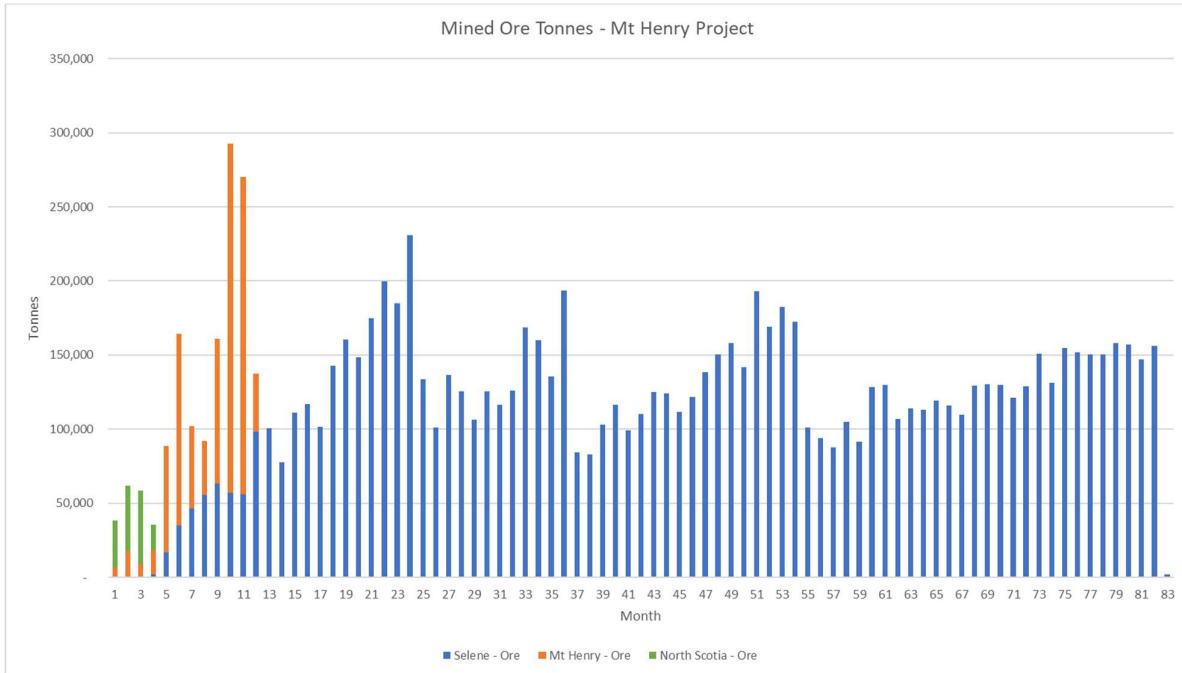

Table 16-26 Mt Henry Project - Mineral Reserves Schedule

Parameter	Unit	Total	Year 1	Year 2	Year 3	Year 4	Year 5	Year 6	Year 7
Mt Henry									
Mined Ore Tonnes	kt	929	929	-	-	-	-	-	-
Mined Grade	g/t	1.5	1.5	-	-	-	-	-	-
Mined Ounces	koz	45	45	-	-	-	-	-	-
Mined Waste Tonnes	kt	13,302	13,302	-	-	-	-	-	-
Total Mined Tonnes	kt	14,231	14,231	-	-	-	-	-	-
Strip Ratio	W:O	14.3	14.3	-	-	-	-	-	-
North Scotia									
Mined Ore Tonnes	kt	142	142	-	-	-	-	-	-
Mined Grade	g/t	1.8	1.8	-	-	-	-	-	-
Mined Ounces	koz	8	8	-	-	-	-	-	-
Mined Waste Tonnes	kt	1,611	1,611	-	-	-	-	-	-
Total Mined Tonnes	kt	1,753	1,753	-	-	-	-	-	-
Strip Ratio	W:O	11.3	11.3	-	-	-	-	-	-
Selene									
Mined Ore Tonnes	kt	9,759	431	1,749	1,629	1,368	1,624	1,448	1,510
Mined Grade	g/t	1.3	1.2	1.2	1.3	1.3	1.3	1.4	1.3
Mined Ounces	koz	405	16	67	68	56	69	64	65
Mined Waste Tonnes	kt	33,157	5,451	14,637	6,920	3,051	1,762	873	463
Total Mined Tonnes	kt	42,916	5,881	16,387	8,548	4,419	3,386	2,321	1,973
Strip Ratio	W:O	3.4	12.6	8.4	4.2	2.2	1.1	0.6	0.3
Total									
Mined Ore Tonnes	kt	10,830	1,502	1,749	1,629	1,368	1,624	1,448	1,510
Mined Grade	g/t	1.3	1.4	1.2	1.3	1.3	1.3	1.4	1.3
Mined Ounces	koz	459	69	67	68	56	69	64	65
Mined Waste Tonnes	kt	48,070	20,364	14,637	6,920	3,051	1,762	873	463

Parameter	Unit	Total	Year 1	Year 2	Year 3	Year 4	Year 5	Year 6	Year 7
Total Mined Tonnes	kt	58,900	21,865	16,387	8,548	4,419	3,386	2,321	1,973
Strip Ratio	W:O	4.4	13.6	8.4	4.2	2.2	1.1	0.6	0.3

16.2.3.8 Mobile Equipment

The loading and hauling fleet selected for the purposes of cost estimation comprises a number of Caterpillar 6020B excavator (220 t operating weight) matched to a Caterpillar 777G rigid body dump truck (approximately 91 t payload). Assuming a continuous 12 hour shift and reasonable assumption for availability and utilisation, one excavator can mine approximately 8 Mtpa. Multiple excavators are planned early in the project life, with the number decreasing as the pit strip ratio decreases, to maintain a steady rate of ore supply to the mill.

An associated fleet of dozers, graders and water trucks was also selected to support primary mine production, including the following.

- 1 x Caterpillar D10T dozer for each excavator;
- 1 x Caterpillar 16M grader for each excavator; and
- 1 x Caterpillar 777G water truck for each excavator.

16.2.3.9 Site Layout

The previous Mt Henry infrastructure area will be utilised for workshop, mine contractors' facilities and the Karora technical and administrative facilities.

The PFS assumption is that ore will be hauled by mine trucks to the current Mt Henry stockpile location. From there it will be rehandled to road trucks for transport to the Higgsville Mill.

The MHP infrastructure including ROM stockpiles and road haulage loadout would be located at the existing Mt Henry site.

Note that the location of the previous magazine will be re-established for the proposed operation.

16.2.4 Other Open Pits

This section describes the mining methods applicable to the Atrides and Musket Mineral Reserves.

16.2.4.1 Open Pit Mining Infrastructure

As most of these open pits are routine drill, blast, load and haul operations, located close to the Higgsville Mill, no additional mining infrastructure will be required. As part of the stripping costs and contractor costs, equipment parking areas and small/fit-for-purpose maintenance areas will be allocated. Housing of mining contractors is possible within the town of Norseman for the Musket Pit which is located 90 km from the Higgsville camp and only 36 km from Norseman township.

16.2.4.2 Mining Methods

The mining method for these open pits are drill, blast loading by excavator, trucking the waste rock to a dedicated waste rock dump area close to the pit and ore trucked to a local pit stockpile or directly trucked to the Higginsville Mill.

Mining will take place in benches with flitch loading (on either 2.5 m or 3 m high flitches). The open pit operations require diligent ore control/grade control procedures and resources. Grade control RC drilling will be performed ahead of blasting when required and the drilling chip samples assayed and in combination with the planning block model, zones within the ore bench demarcated (by coloured tape/spray or a combination of the two) to define if a parcel of ore is low grade, medium or high-grade.

The post loading grade control process is important to ensure the reconciliation is in-line with planning and to ensure ore modifying factors are reasonable and follow due process.

The typical open pit mining cycle involves:

- Demarcation (on each bench level) of ore/waste and low-grade zones;
- RC drilling (grade control drilling prior to mining to refine/update waste/ore zones);
- Bench drilling floor preparation and survey depths for each blast hole (depth/lengths of each blast hole are key to ensure bench floor controls);
- Drilling of blast holes;
- Review and QA/QC of blast holes to ensure they are drilled to design;
- Re-drilling of any holes not deemed correct/appropriate;
- Charging and firing of blast holes;
- Loading of the heave;
- Loading of the flitches, loading to be supervised in ore blocks to ensure correct truck destinations; and
- Trucks haul ore to either a lower grade stockpile close to the open pit or directly to the Higginsville Mill.

16.2.4.3 Hydrology

Most of the open pits (historical pits) in the Higginsville Greater area have groundwater inflows and there is obvious rain/surface water ingress throughout rain events. Atriedes is located next to Lake Cowan; however, drilling and recent exploration has proven these areas to be dry (within the planned open pit areas). Hydrogeological modelling suggests a likely ground water inflow of 17 L/s while mining Musket Pit. Apart from dust suppression usage within the project area, excess water from Musket will be discharged via pipeline to Lake Cowan.

Surface water ditches, culverts and bund walls in places around the Atriedes Pit, will be designed to convey surface water runoff away from the open pit operations (as far as practicable). These designs will be informed by hydrogeological modelling.

Engineering work will be undertaken to ensure surface drainage and runoff surrounding the Musket Project area continues as currently established. Runoff naturally flows towards Lake Cowan. Stormwater runoff will be channelled around any proposed pits. The Musket Project is located on comparatively flat ground to the southeast of Lake Cowan. No diversions will be required as pits and waste dumps will be positioned outside of main drainage lines. There are no expected drainage issues with this project, as it does not sit within a floodway or main drainage line.

16.2.4.4 Geotechnical

The recommended pit and slope design parameters are best described in Table 16-27 and Table 16-28.

Table 16-27 Musket recommended pit and slope design parameters

Criterion	Value	Description
East & South Wall		
Face Height:	10 m	First Bench (10m)
Face Height:	15 m	Second Bench (15m)
Face Height:	20 m	Following Benches
Face Angle:	55°	First Bench (10m)
Face Angle:	60°	Second Bench (15m)
Face Angle:	65°	Following Benches
Berm Width	5 m	First Bench (10m)
Berm Width	6 m	Second Bench (15m)
Berm Width	7 m	Following Benches
West & North Wall		
Face Height:	10 m	First Bench (10m)
Face Height:	15 m	Second Bench (15m)
Face Height:	20 m	Following Benches
Face Angle:	60°	First Bench (10m)
Face Angle:	65°	Following Benches
Berm Width	5 m	First Bench (10m)
Berm Width	6 m	Second Bench (15m)
Berm Width	7 m	Following Benches+

Table 16-28 Lake Cowan (Atriedies) recommended pit and slope design parameters

Criterion	Value	Description
All Walls:		
Face Height:	10 m	First Bench (10m)
Face Angle:	60°	First two Bench (20m)
Face Angle:	65°	Thereafter
Berm Width	5 m	All Benches (10m face heights)

16.2.4.5 Historical Mining

There are several open pit voids/historical open pit operations in and around the Higginsville Central open pit target zones. With the abundance of historical mining, existing pit walls pointed to reasonably good to fair ground conditions with minimal major slope damage. Ongoing review of pit-specific geological structures and jointing, and the relative face angles to these features and joints is very important as it could indicate potential increase in the probability of failure.

It is furthermore advised that slope monitoring systems be considered when starting to develop these open pits at depths greater than 30 m. A geotechnical engineer will review each of the pit

designs and may require further design alterations. These should be facilitated at or prior to mining commencement at the respective open pits.

16.2.4.6 Mine Design

Table 16-29 depicts the typical pit design criteria for each of the open pits.

Table 16-29 Pit design parameters

Description	Atreides	Musket
Bench Height m	10	10
Typical Face Angles (Oxides)	60°	55°
Typical Face Angles (Transition Rock)	65°	60°–65°
Typical Face Angles (Fresh Rock)	N/A	70°
Typical Berm Width (Oxides) m	5	5
Typical Berm Width (Transition Rock) m	5	5
Typical Berm Width (Fresh Rock) m	N/A	5
Overall Slope Angles (Ranges)	47°–50°	40°–54°
Ramp Width m (Single Lane – Dual Lane)	8–12.5	7.5–12.5
Ramp Inclination %	10	11
Pit Depth (max) m	38	76

Some design parameters differ from geotechnical recommendations; however, these differences result in more conservative overall slope angles. It is recommended that prior to mining, a design review is completed to determine if the pit walls can be steepened.

The mine designs were developed in Deswik software. Figure 16-26 and Figure 16-27 depict the pit designs for the Higginsville Greater open pit deposits.

Figure 16-26 Atrides Mineral Reserve design

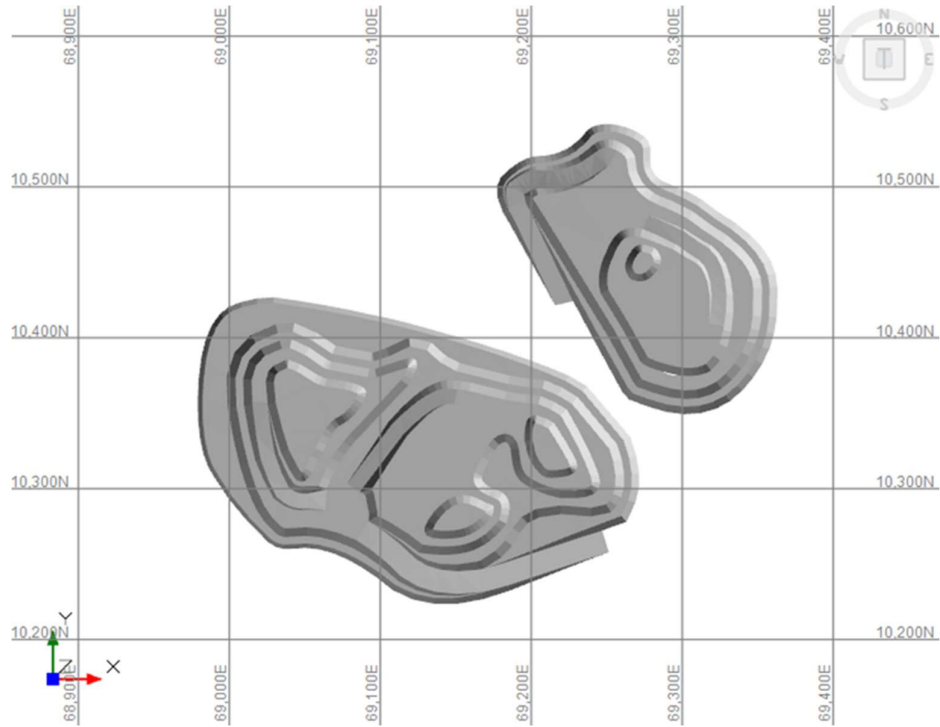
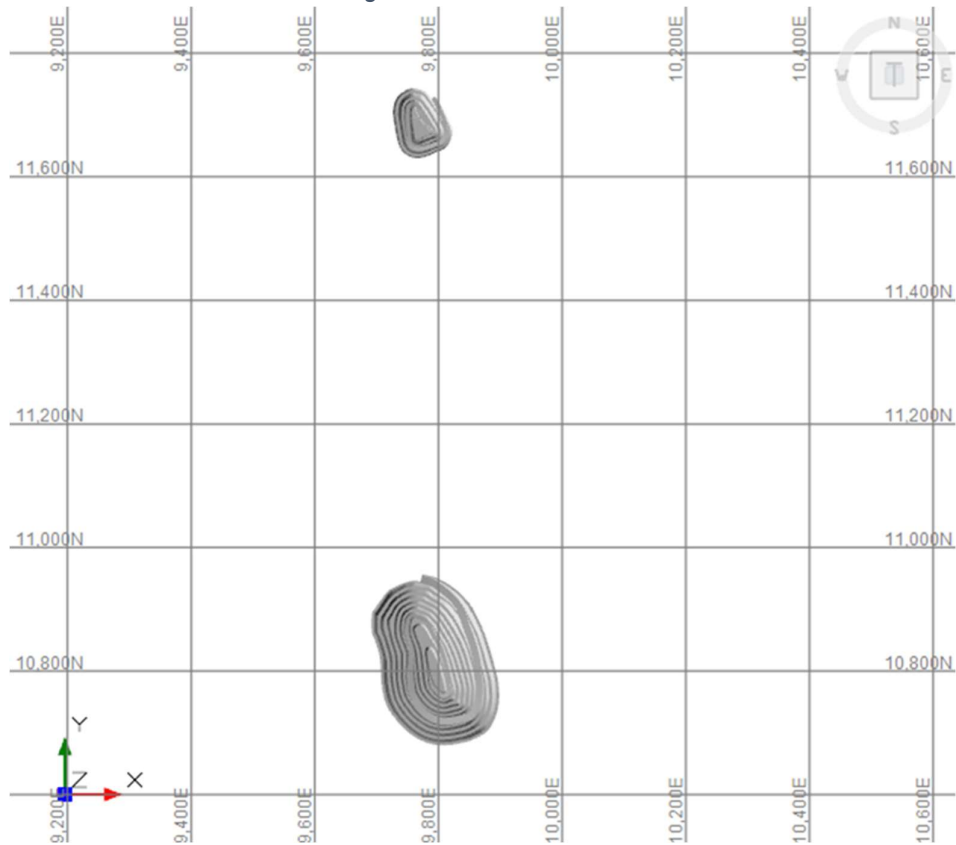

Figure 16-27 Musket Mineral Reserve design



16.2.4.7 Mine Scheduling

The open pits were scheduled in the Deswik software package. Rates were determined using historical actuals, given the current contract mining fleet at Pioneer will be similar to the fleet employed at Atreides and Musket. Maximum dig rates were set to 300 kbcm/month, and reduced depending on available working areas, interactions with other activities in the pit (grade control drilling or blast hole drilling) and working bench area. The mining schedules are considered realistic and achievable considering past performance.

The Atreides Mineral Reserves schedule is detailed in Table 16-30.

Table 16-30 Atreides Mineral Reserves schedule

	Unit	Total	Month 1	Month 2	Month 3	Month 4
Mined Ore Tonnes	kt	191	13	70	90	18
Mined Grade	g/t	1.8	1.6	1.7	1.9	1.7
Mined Ounces	koz	11	1	4	6	1
Mined Waste Tonnes	kt	1,901	649	598	602	53
Total Mined Tonnes	kt	2,092	662	668	692	71
Strip Ratio	W:O	10.0	49.9	8.5	6.7	2.9

- 1) The tonnes and grades are stated to a number of significant digits reflecting the confidence of the estimate. Since each number is rounded individually, the table may show apparent inconsistencies between the sum of rounded components and the corresponding rounded total.

The Musket Mineral Reserves schedule is detailed in Table 16-31.

Table 16-31 Musket Mineral Reserves schedule

	Unit	Total	Month 1	Month 2	Month 3	Month 4	Month 5	Month 6	Month 7
Mined Ore Tonnes	kt	187	5	15	24	18	32	40	53
Mined Grade	g/t	2.8	3.2	2.5	2.2	2.1	2.6	3.1	3.3
Mined Ounces	koz	17	1	1	2	1	3	4	6
Mined Waste Tonnes	kt	2,862	691	707	566	325	290	174	109
Total Mined Tonnes	kt	3,049	696	723	589	343	322	214	162
Strip Ratio	W:O	15.3	138.2	47.1	23.6	18.1	9.1	4.4	2.1

- 1) The tonnes and grades are stated to a number of significant digits reflecting the confidence of the estimate. Since each number is rounded individually, the table may show apparent inconsistencies between the sum of rounded components and the corresponding rounded total.

16.2.4.8 Mobile Equipment

The open pits are planned/mined by means of open pit excavators and haul trucks (typical small open pit mining equipment). The mining is done by contractors (reputable open pit Australian mining contractors) and the specific equipment units may vary as the contractor sees fit. At present, mining of Pioneer is completed using a 120 t and an 80 t excavator matched to a fleet of 60 t capacity trucks and it is expected that a similar fleet will mine Atreides and Musket.

16.2.4.9 Site Layout

These open pits do not need or have any specific site infrastructure. The only basic facilities they will have is parking areas for the mining equipment, possibly one or two small on-site mobile offices and ablutions, a mobile service truck or tank and rock dump laydown areas (low grade ore and waste rock dump areas). There were no specific waste rock dump designs completed for each pit, but there is ample dumping space at each pit/area and the typical dump design criteria can be described as shown in Table 16-32.

Table 16-32 Dump design criteria

Angle of dump repose during construction	34°
Final remediated batter slope angle	15°
Dump lift height	15m
Dump safety berm	15m

17 PROCESSING

17.1 HIGGINSVILLE MILL

Karora treats gold mineralisation at its Higginsville Mill, a 1.6 Mtpa conventional CIL processing plant, built by GR Engineering Services in 2007 and commissioned in 2008. The mill consists of an open circuit jaw crusher followed by closed circuit secondary and tertiary crushers, a fine ore bin, ball mill, gravity separation circuit, one leach tank and six carbon adsorption tanks. A quaternary stage hard rock crushing circuit was incorporated in 2010.

The primary sections of the processing plant shown in Figure 17-1 that are currently in use are:

- Crushing and conveying;
- Ore storage and reclaim and grinding;
- Leaching and carbon adsorption;
- Carbon stripping, electrowinning, refining and carbon regeneration;
- Tailings deposition and storage;
- Reagent mixing and handling; and
- Plant services.

Figure 17-1 Higginsville process flowsheet 2020

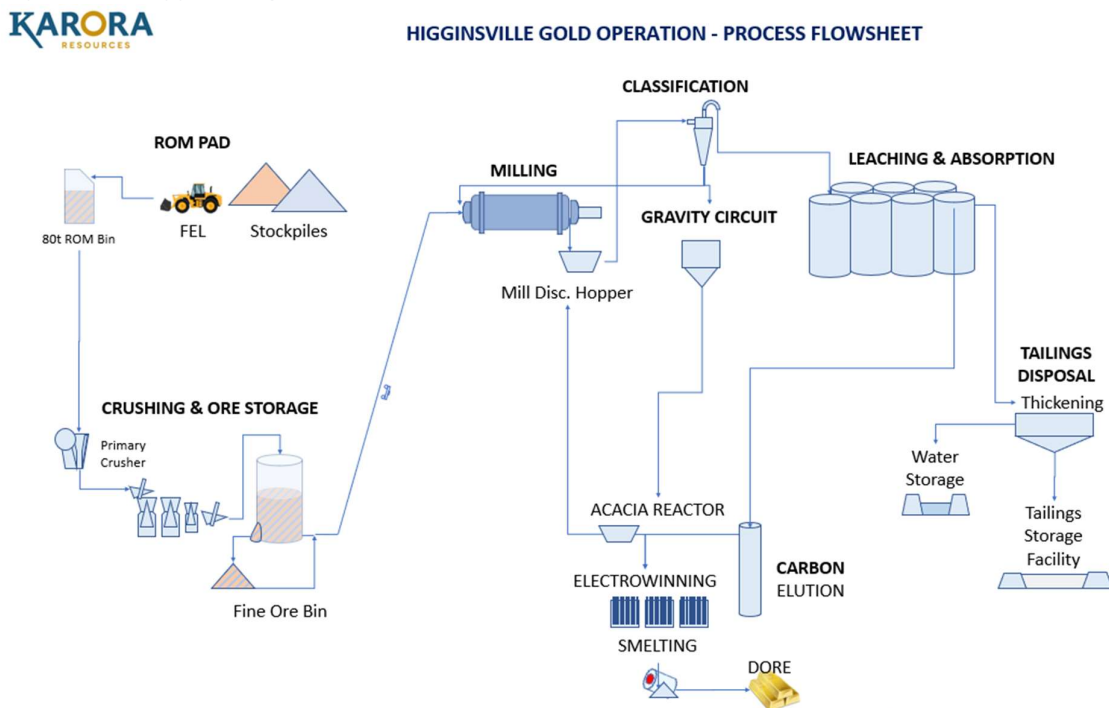

17.1.1 Process Description

17.1.1.1 Crushing

Mill feed is trucked to the ROM pad from open pits in the immediate Higginsville area together with underground ore from the Beta Hunt Mine located 80 km to the north. The mill feed is classified and stockpiled according to gold grade to blend an optimal feed mix to the mill. Oversize mill feed is sorted from stockpiles and broken on the ROM pad using a front end loader (FEL) and a rock breaker. Any oversize that cannot pass through the primary crusher grizzly is broken by a rock breaker.

The crushing circuit consists of four stages of crushing:

- A 36 x 48 Trio primary single-toggle jaw crusher;
- A 1.68 m Trio Turbocone TC66 (standard configuration) secondary cone crusher;
- A 1.68 m Trio Turbocone TC66 (short head configuration) tertiary cone crusher; and
- A 1.29 m Trio Turbocone T51 quaternary cone crusher.

There are also separate surge bins that operate in closed circuit with a 2.4 m wide by 7.3 m long Oreflow double deck vibrating screen.

Crushed material exits the product screen with a P_{80} of 10 mm and is stored in the fine ore bin, which has a live capacity of 1,500 t.

The crushing circuit contains one Ramsey belt scale for measuring mass of circuit ore.

17.1.1.2 Grinding

Crushed mill feed is withdrawn from the fine ore bin via a belt feeder, which transfers the crushed product onto the mill feed conveyor that feeds into the ball mill. Mill feed can also be fed via an emergency feeder, which is fed from the fine ore stockpile via FEL.

The grinding circuit consists of an overflow ball mill, hydrocyclone cluster classifier and gravity recovery circuit. The ball mill is a 4.90 m diameter by 6.77 m effective grinding length (EGL) LMMP/CITIC-HMC overflow ball mill.

The crushed mill feed is conveyed to the ball mill feed chute and combined with process water and recirculating cyclone underflow slurry. The ball mill operates in closed circuit with the mill discharge slurry classified by a cluster of hydrocyclones.

Oversize ore particles and reject grinding balls are removed from the ball mill discharge slurry by a 16 mm aperture trommel screen connected to the discharge trunnion of the mill. The oversize material (mill scats) is removed from the circuit to protect the cyclone feed slurry pumps and reduce wear rate on cyclone liners and the slurry handling equipment. Mill scats are rejected to a scats bin for removal by wheel loader.

Slurry from the grinding and classification circuit passes over a trash screen to ensure that no oversize particles enter the leaching circuit and to remove plastic and other containments from the slurry. The trash screen is a 1.5 m wide by 3.6 m long horizontal vibrating screen with an aperture size of 0.80 mm. Undersize from the trash screen is directed to the leach feed distributor ahead of the 1,000 m³ leach tank.

17.1.1.3 Gravity and Intensive Cyanidation

A gravity separation circuit is included in the design to improve the gold recovery from the hydrocyclone underflow stream.

A 100 t/h bleed of the hydrocyclone underflow stream is classified by the gravity feed screen, which is a 1.2 m wide by 2.4 m long horizontal vibrating screen with an aperture size of 3.25 mm.

Oversize from this screen returns to the ball mill feed chute for further grinding. Undersize material reports to a centrifugal concentrator to extract the gold. The gravity concentrator is a XD40 Knelson Concentrator.

The resulting concentrate is subjected to intensive cyanidation in a CS1000DM ConSep Acacia dissolution module to recover the gold. Pregnant solution from the intensive cyanidation process is pumped to the gold room for electrowinning in a CS1000EW ConSep electrowinning module.

17.1.1.4 Leaching and Adsorption

The leach and adsorption circuit consists of one 1,000 m³ leach tank and six 1,000 m³ CIL carbon adsorption tanks.

All tanks are mechanically agitated with dual, open, down-pumping impellor systems powered by 55 kW drives. Facilities are currently available to inject oxygen into Tanks 1, 2 and 3 with a high shear oxygen injector pump recirculating into Tank 1.

Leach Tank 1 is the initial oxidation (oxygen sparged) tank and receives the initial dosing of cyanide. Slurry flows from this tank into the carbon adsorption circuit.

Dissolved gold in the cyanide leach solution is recovered and concentrated by adsorption onto activated carbon (Haycarb) in the adsorption tanks.

Cyanide solution at 30% strength by weight is added to the leach tank feed distributor box and/or the first CIL tank via a flow meter and automatic control valve. The design leaching residence time is 5 hours.

Discharge from the leach tank overflows into the first of six 1,000 m³ CIL tanks, each with an average effective working volume of 984 m³. The combined adsorption residence time is 30 hours.

In the CIL tanks, the carbon is advanced counter-current to the slurry flow, with new and regenerated carbon added to the last tank and advanced to the first tank while the slurry flows from CIL Tank 1 to Tank 6. Loaded carbon is periodically pumped from Adsorption Tank 1 to the gold room elution circuit for stripping of the gold.

The target pH in the leach circuit is 8.6, and the target cyanide concentration is up to 300 ppm. An on-line free cyanide analyser is used to control the cyanide addition. Cyanide can be added to Tank 1 and Tank 3. Dissolved oxygen probes are installed in Tanks 1 and 2.

17.1.1.5 Carbon Stripping, Electrowinning, Refining, and Carbon Regeneration

Gold is recovered from the loaded carbon by a Pressure Zadra electrowinning circuit. Gold is deposited onto steel wool cathodes by the electrowinning cells. The cathodes are subsequently washed to remove the gold concentrate which is then dried and smelted in the gold room furnace to produce gold bullion for shipment.

The gold from the gravity circuit is leached in the Acacia reactor, and it is then electroplated by the Acacia electrowinning circuit onto steel wool cathodes in the Acacia cell. The gold is recovered and smelted in a similar manner to the gold produced by the Pressure Zadra circuit.

Barren carbon is reactivated using a liquified natural gas (LNG) fired horizontal kiln at around 700°C and is returned to the adsorption circuit for reuse.

17.1.1.6 Tailings Disposal

Slurry from the last CIL tank flows by gravity to the feed box of the tailings screen. The tailings screen is a 1.5 m wide by 3.6 m long horizontal vibrating screen with an aperture size of 0.8 mm. The screen undersize flows by gravity to either the tailings thickener or directly to the tailings pump hopper.

The screen oversize (trash and carbon fines) is collected and stored in a self-draining carbon fines bin located at ground level.

Plant tailings slurry is pumped through a polyethylene pipeline to the TSF. Pressure and flow in the lines is monitored on the Citect system to detect high pressures that result from line obstructions or sanding, or low pressure resulting from possible pipe failures.

17.1.1.7 Plant Services

All necessary plant services are available to support the operation of the Higginsville Mill. Raw water is sourced from the main production source at the disused Chalice open pit 16 km to the west.

Process water is stored for use in a 5,000 m³ process water dam. Process water is made up of raw water from the Chalice production source and tailings return water. Incoming raw water from Chalice reports to the disused Aphrodite pit before it is pumped to the 2,000 m³ site raw water dam.

Potable water is sourced from the WA Water Corporation supply line from Kalgoorlie to Norseman. Potable water is utilised in the process plant, administration building, workshop, stores, main camp and mining offices.

High pressure air is provided at a nominal pressure of 650 kPa.

Power is generated in the diesel power station at 11 kV and distributed to various plant, the disused Trident mine area and the camp.

17.1.2 Plant Performance

The Higginsville Mill has been in operation since 2008 with historical throughput vs recoveries for the past two years shown in Figure 17-2.

Recoveries have ranged from 91.3% to 95.5% since January 2022, with the average recovery at 93.8%.

Figure 17-2 Higginsville – process recoveries vs plant throughput

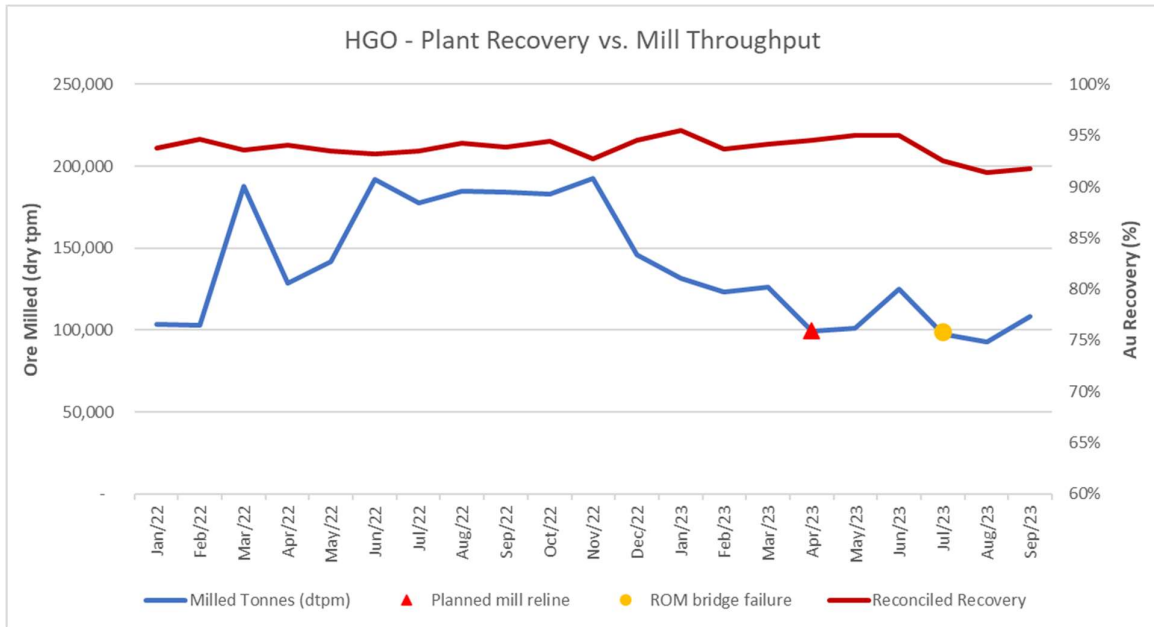
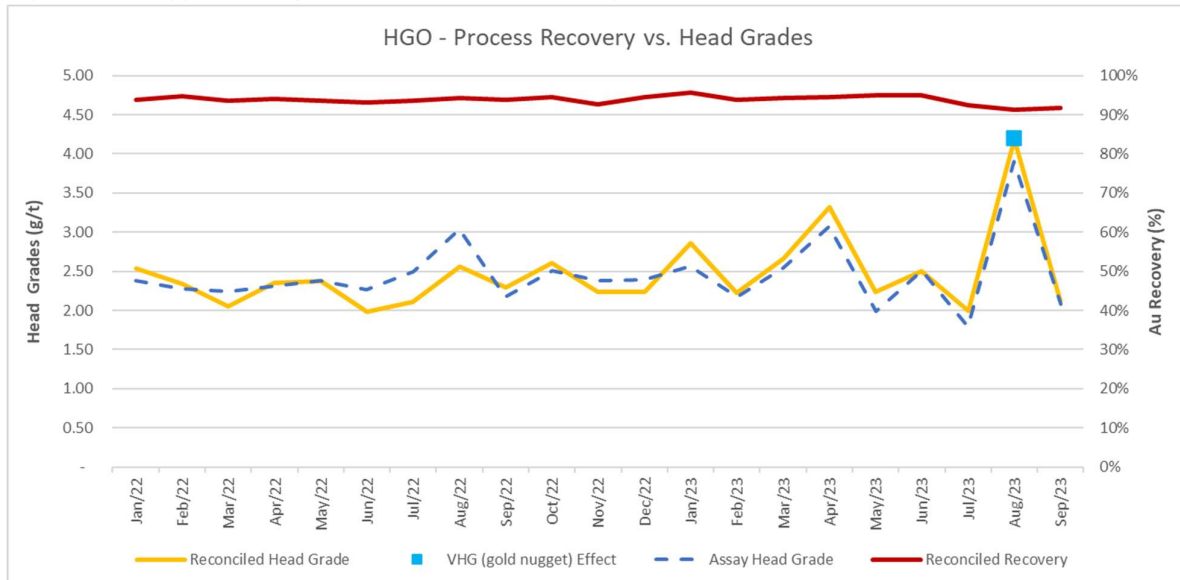

Figure 17-3 shows the historical processing recoveries against the calculated/reconciled and assayed head grades, showing a steady plant recovery performance against the head grade. The variance between reconciled (calculated) and assayed head grades over the period has been less than 1% with an average reconciled head grade at 2.47 g/t Au.

The tails grade during the same period of time has ranged from 0.11 g/t Au to 0.36 g/t Au, with an average tail grade of 0.15 g/t Au.

Figure 17-3 Higginsville – process recoveries vs head grade



As expected, and as shown in Figure 17-4, there is a correlation between the head grade and the tails grade discharge from the mill to the TSF.

Figure 17-4 Higginsville – head grades vs tail grades

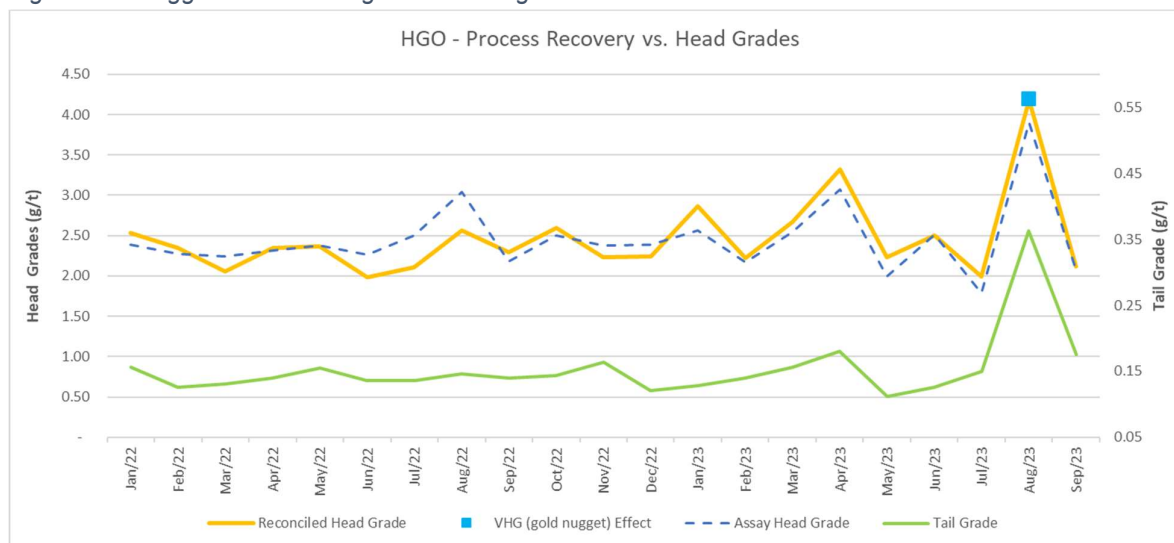

17.2 LAKEWOOD MILL

Karora treats gold mineralisation at its Lakewood Mill, a 1.0 Mtpa conventional CIL processing plant, which consists of contract crushing, ball mill, gravity separation circuit, one leach tank and seven carbon adsorption tanks.

The primary sections of the processing plant that are currently in use are:

- Crushing and conveying;
- Ore storage and reclaim and grinding;
- Leaching and carbon adsorption;
- Carbon stripping, electrowinning, refining and carbon regeneration;
- Tailings deposition and storage;
- Reagent mixing and handling; and
- Plant services.

17.2.1 Process Description

17.2.1.1 Crushing

Mill feed is trucked to the ROM pad from the underground Beta Hunt Mine located 56 km to the south. The mill feed is classified and stockpiled according to gold grade and is not typically blended. Oversize mill feed is sorted from stockpiles and broken on the ROM pad using a loader or excavator. Any oversize that cannot pass through the primary crusher grizzly is broken by a rock breaker.

The crushing is provided by a contract crushing provider who uses a variety of mobile crushing equipment, including jaw and cone crushers plus screens, to achieve a final crushed product with a P₈₀ of 10 mm. This product is then stockpiled by a radial stacker onto the ground.

The crushing circuit contains one Ramsey belt scale for measuring mass of circuit ore.

17.2.1.2 Grinding

Crushed mill feed is fed by a FEL via a belt feeder, which transfers the crushed product onto the mill feed conveyor that feeds into the ball mill.

The grinding circuit consists of a grate discharge ball mill, hydrocyclone cluster classifier and gravity recovery circuit.

The crushed mill feed is conveyed to the ball mill feed chute and combined with process water and recirculating cyclone underflow slurry. The ball mill operates in closed circuit with the mill discharge slurry classified by a cluster of hydrocyclones.

Oversize ore particles and reject grinding balls are removed from the ball mill discharge slurry by a 16 mm aperture trommel screen connected to the discharge trunnion of the mill. The oversize material (mill scats) is removed from the circuit to protect the cyclone feed slurry pumps and reduce wear rate on cyclone liners and the slurry handling equipment. Mill scats are rejected to a scats bin for removal by wheel loader.

Slurry from the grinding and classification circuit is passed over a trash screen to ensure that no oversize particles enter the leaching circuit and to remove plastic and other containments from the slurry. The trash screen is a 1.5 m wide by 3.6 m long horizontal vibrating screen with an aperture size of 0.80 mm. Undersize from the trash screen is directed to the leach feed distributor ahead of the 1,546 m³ leach tank.

17.2.1.3 Gravity and Intensive Cyanidation

A gravity separation circuit is included in the design to improve the gold recovery from the hydrocyclone underflow stream.

The hydrocyclone underflow stream is classified by two gravity feed with an aperture size of 3.25 mm.

Oversize from these screens returns to the cyclone feed hopper for reintroduction back into the milling circuit. Undersize material reports to two centrifugal concentrators to extract the gold. The gravity concentrators are two XD30 Knelson Concentrator, which are always in operation.

The resulting concentrate is subjected to intensive cyanidation in a CS1000DM ConSep Acacia dissolution module to recover the gold. Pregnant solution from the intensive cyanidation process is pumped to the gold room for electrowinning in a CS1000EW ConSep electrowinning module.

17.2.1.4 Leaching and Adsorption

The leach and adsorption circuit consists of one 1,546 m³ leach tank and seven CIL carbon adsorption tanks, with total capacity of 2,337 m³.

All tanks are mechanically agitated with dual, open, down-pumping impellor systems powered by 55 kW drives. Facilities are currently available to inject oxygen into Tanks 1, 2 and 3 with a high shear oxygen injector pump recirculating into Tank 1.

Leach Tank 1 is the initial oxidation (oxygen shear pump) tank and receives the initial dosing of cyanide. Slurry flows from this tank into the carbon adsorption circuit.

Dissolved gold is recovered from the cyanide leach solution and concentrated by adsorption onto activated carbon (Haycarb) in the adsorption tanks.

Cyanide solution at 30% strength by weight is added to the leach tank feed distributor box and/or the first CIL tank via a flow meter and automatic control valve. The design leaching residence time is 12.8 hours.

Discharge from the leach tank overflows into the first of seven CIL tanks (Tanks 11 to 17) with a combined adsorption residence time of 20 hours.

In the CIL tanks, the carbon is advanced counter-current to the slurry flow, with new and regenerated carbon added to the last tank and advanced to the first tank as the slurry flows from Tank 11 to Tank 17. Loaded carbon is pumped from adsorption Tank 11 to the gold room elution circuit periodically for stripping of the gold.

The target pH in the leach circuit is 9.6 and the target cyanide concentration is up to 260 ppm. Cyanide can be added to Tank 11 and Tank 13.

17.2.1.5 Carbon Stripping, Electrowinning, Refining, and Carbon Regeneration

Gold is recovered from the loaded carbon by a Pressure Zadra electrowinning circuit. Gold is deposited onto steel wool cathodes by the electrowinning cells. The cathodes are subsequently washed to remove the gold concentrate, which is then dried and smelted in the gold room furnace to produce gold bullion for shipment.

The gold from the gravity circuit is leached in the Acacia reactor, and it is then electroplated by the Acacia electrowinning circuit onto steel wool cathodes in the Acacia cell. The gold is recovered and smelted in a similar manner to the gold produced by the Pressure Zadra circuit.

Barren carbon is reactivated using a LNG fired horizontal kiln at around 700°C and returned to the adsorption circuit for reuse.

17.2.1.6 Tailings Disposal

Slurry from the last CIL tank flows by gravity to the feed box of the tailings screen, which is a 1.5 m wide by 3.6 m long horizontal vibrating screen with an aperture size of 0.8 mm. The screen undersize flows by gravity to the tailings pump hopper.

The screen oversize (trash and carbon fines) is collected and stored in a self-draining carbon fines bin located at ground level.

Plant tailings slurry is pumped through a polyethylene pipeline to the TSF. Pressure and flow in the lines is monitored on the Citect system to detect high pressures that result from line obstructions or sanding, or low pressure resulting from possible pipe failures.

17.2.1.7 Plant Services

All necessary plant services are available to support the operation of the Lakewood Mill. Raw water is delivered by truck from Kalgoorlie for use where clean water is required in the process.

Process water stored in the process water tanks is made up of bore water, tailings return water from Lakewood, and offtake from Kalgoorlie Consolidated Gold Mines (KCGM). Potable water trucked in from the WA Water Corporation in Kalgoorlie is utilised in the process plant, administration building, workshop and stores.

High pressure air is provided at a nominal pressure of 650 kPa.

Power is drawn from the local power grid.

17.2.2 Plant Performance

The Lakewood Mill has been in steady operation since acquisition. Toll treatment campaigns over the period has declined as the plant is continuously supplied with ore from Beta Hunt Mine.

Mill throughput has been consistent at 115 t/h while improvement projects to ramp up continues.

Figure 17-5 Lakewood – process recoveries vs plant throughput

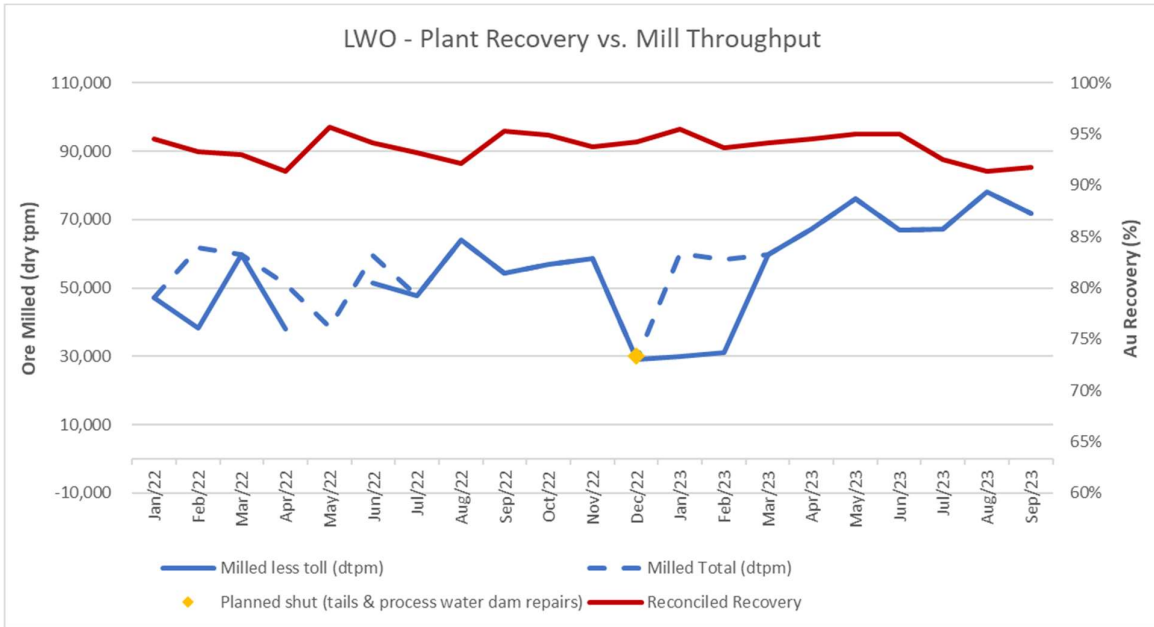

Recoveries have ranged from 91.4% to 95.7% since January 2022, with the average recovery at 93.8%.

The plant recovery over the period has been steady as shown in Figure 17-5 while the plant head grade has ranged from 1.76–2.26 g/t Au. The variance between reconciled and assayed head grades over the period has been less than 5% with an average reconciled head grade at 1.76 g/t Au.

Figure 17-6 Lakewood – process recoveries vs head grade

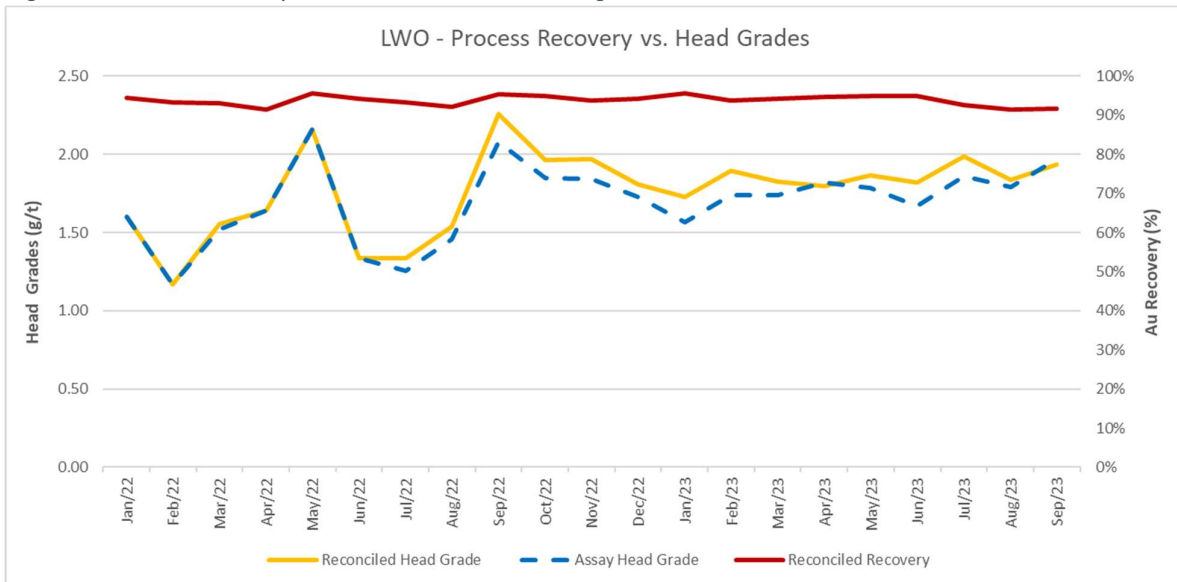
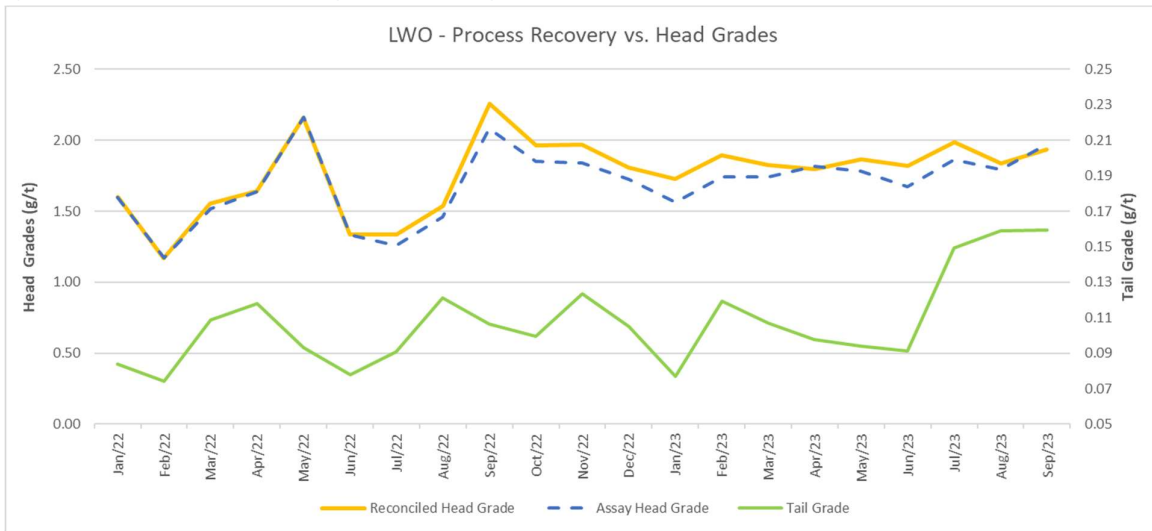

Figure 17-7 shows a steady correlation between the head grade and tails grade discharged from the mill to the TSF with an average tail grade of 0.15 g/t Au.

Figure 17-7 Lakewood – head grades vs tail grades



18 PROJECT INFRASTRUCTURE

18.1 HIGGINSVILLE MILL

The HGO is a well-established mine which has services and infrastructure consistent with an isolated area operating mine.

Infrastructure specific and available to the Higginsville Mill include:

- 1.6 Mtpa processing plant and supporting infrastructure;
- Power station;
- Gatehouse;
- Medical facilities;
- Accommodation village;
- Administration block and training buildings;
- Fuel storage and dispensing facility;
- Waste water treatment plant; and
- Water storage and distribution and tailings facilities.

18.1.1 Utilities

Electricity is generated on site by a diesel-powered generating station consisting of eight duty units and one standby unit, 850 kW each (Figure 18-1). Supply is reticulated to all the site buildings, services, camp and mill.

Figure 18-1 HGO powerhouse



Potable water is sourced from the WA Water Corporation supply line from Kalgoorlie to Norseman.

18.1.2 Disposal and Drainage

Both domestic and industrial waste is disposed of by burial at the Higginsville landfill site located on the Barmingo waste dump.

Sewage from the camp, main administration building and the processing plant ablutions is disposed of via a sewage pumping system and a Waste Water Treatment Plant located to the north of the mill.

All used oils, greases and lubricants are collected and removed from site for recycling or disposal. Waste oil from mobile and fixed equipment is stored on site within existing bunded storage areas. Oil is transported to an oil recycling facility in Perth on a regular basis. Any oil-contaminated ground is treated on site using existing bioremediation treatment facilities.

18.1.3 Buildings and Facilities

All infrastructure required for mineral processing is in place and operational, including offices, workshops, first aid/emergency response facilities, stores, water and power supply, ROM pad and site roads (Figure 18-2 to Figure 18-4).

Figure 18-2 HGO underground workshop



Figure 18-3 HGO light vehicle workshops



Figure 18-4 Higginsville Mill and workshop/store



Higginsville operates primarily as a FIFO operation and maintains a camp on site for the employees and contractors. A small number of employees drive in/out from Esperance, Kambalda and Kalgoorlie.

The camp has a room capacity for 240+ persons, and includes wet and dry mess facilities, a recreational gymnasium and entertainment room.

18.1.4 Communications

The mine site has a communication network of landline and mobile telephones within the administration, camp and mill areas, and licensed UHF radio repeaters within the Main Pit mining areas. Outside these areas, communication is by means of radio or satellite phone only.

18.1.5 Tailings Storage

Higginsville has several approved sites for the deposition of tailings, including four paddock-style TSFs 1–4, Aphrodite in-pit, Fairplay in-pit and Vine in-pit TSFs. The TSF 2–4 supercell, constructed on TSF 2, TSF 3 and TSF 4 is the current location for tailings deposition.

Both the Aphrodite and Fairplay in-pit TSFs and TSF 1 have reached full capacity. The Vine in-pit TSF is close to capacity and is reserved for tailings storage during construction periods of future TSF 2–4 stage raises.

For TSF 2–4, a further two stage raises of 2.5 m will provide tailings storage capacity for another 2.5 years.

Karora is currently undertaking prefeasibility studies for TSF 5 at Higginsville. It is expected Karora will make a decision on the location for the next tailings storage facility within the next six months.

18.2 LAKEWOOD MILL

The Lakewood Operations is a well-established mill which has services and infrastructure consistent with an isolated area operating mill.

Key infrastructure includes the following:

- 1.0 Mtpa processing plant and supporting infrastructure;
- Administration block and training buildings;
- Contractors crushing facilities;
- Maintenance workshop and stores;
- Fuel storage and dispensing facility;
- Muster/crib room and ablutions; and
- Tailings storage facilities.

18.2.1 Utilities

Electricity is mains powered connected to the Southwest Interconnected System.

Water requirements for dust suppression and road maintenance are sourced from borefields located on Lakewood tenements.

18.2.2 Tailings Storage

Karora has recently completed the Stage 8 East lift at Lakewood TSF 1. Subsequent lifts at Lakewood TSF 1 are approved up to and including Stage 10.

Karora has commenced construction of Lakewood TSF 2, which is expected to be completed by mid-2024. Tailings deposition will be alternated between TSF 1 and TSF 2. The approved tailings storage capacity for Lakewood provides approximately five years of additional storage.

19 MARKET STUDIES AND CONTRACTS

19.1 GOLD MARKET STUDIES

The following discussion of gold markets is provided as background to cut-off grade calculations used in this Technical Report.

As shown in Table 19-1, mined gold production totaled 3,625 t in 2022, up from 3,576 t in 2021. Net producer de-hedging of -13 t, plus recycled gold of 1,140 t in 2022, brought the total gold supply to 4,752 t, 45 t higher than 2021. For the YTD Q3 2023 period, total gold supply was estimated to be 3,692 t, 164 t higher than the same period in 2022.

The demand side totaled 4,752 t of gold in 2022. Jewelry, fabrication and technology applications, totaled 2,195 t of demand, while investment, central banks and other institutions net purchases made up the balance of demand. Through the first three quarters of 2023, total gold demand was estimated to be 3,692 t, 101 t higher than the same period in 2022.

Table 19-1 Gold market supply – demand balance Source: World Gold Council

	2013	2014	2015	2016	2017	2018	2019	2020	2021	2022	YTD Q3 2023
Supply											
Mine production	3,167	3,270	3,361	3,515	3,576	3,656	3,596	3,482	3,576	3,625	2,744
Net producer hedging	-28	105	13	38	-26	-12	6	-39	-5	-13	25
Recycled gold	1,195	1,130	1,067	1,232	1,112	1,132	1,276	1,293	1,136	1,140	924
Total Supply	4,334	4,505	4,441	4,785	4,663	4,776	4,878	4,736	4,707	4,752	3,692
Demand											
Jewellery Fabrication	2,735	2,544	2,479	2,019	2,257	2,290	2,152	1,324	2,230	2,195	1,583
Technology	356	348	332	323	333	335	326	303	330	309	216
Investment	800	904	967	1,616	1,315	1,161	1,275	1,794	991	1,113	687
Central banks & other inst.	629	601	580	395	379	656	605	255	450	1,082	800
OTC and other	-186	107	83	432	379	334	520	1,060	706	53	407
Total demand	4,334	4,505	4,441	4,785	4,663	4,776	4,878	4,736	4,707	4,752	3,692
LBMA Gold Price (US\$/oz)	1,411	1,266	1,160	1,251	1,257	1,268	1,393	1,770	1,799	1,800	1,931

Figure 19-1 shows the monthly average price history for gold over the period December 2018 through November 2023. The price generally trended upward over the selected period from a month-average low of US\$1,279/oz at the beginning of the period to a high of US\$1,990/oz in May 2023, ending the selected period at US\$1,985/oz. Over the period 2024 to 2026, consensus annual gold price estimates range from an average annual price of US\$1,921/oz in 2024, US\$1,898/oz in 2025 and US\$1,835/oz in 2026.

The forecast for periods shown in Figure 19-1 from December 2023 out to 2026 is from data compiled by S&P Capital IQ and is based on averages from a survey of 31 analysts for FY 2024, 27 analysts for FY 2025 and 20 analysts for FY 2026.

Figure 19-1 Gold price history and consensus forecast (US\$/oz)

Source: S&P Capital IQ

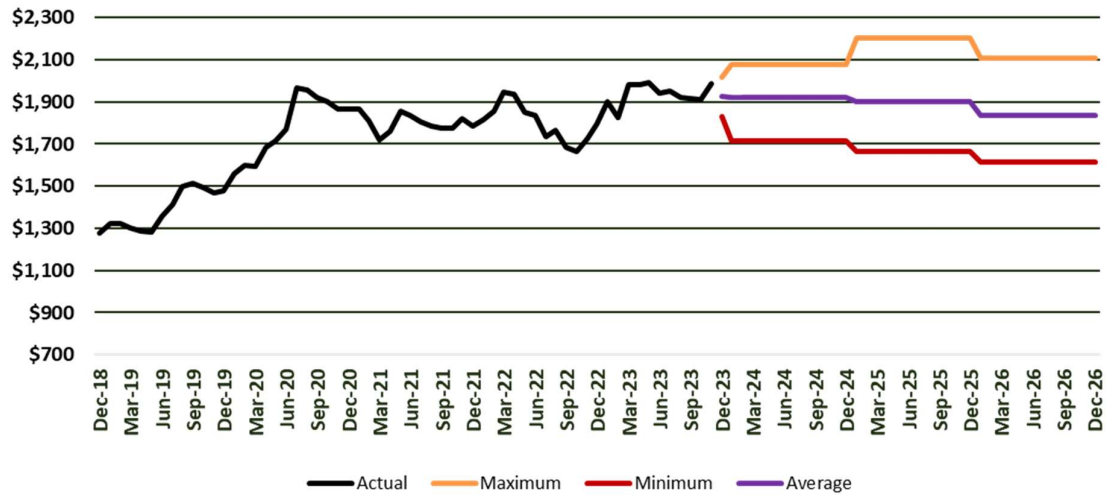

19.2 CONTRACTS

Karora has engaged contractors to conduct mining operations at the Pioneer open pit and the Two Boys underground mines.

Other material contracts relate to haulage of material from the mine to processing facilities, the supply of fuel, electricity and water for the purposes of mining activities, and the contract for the refining of gold doré produced from Karora’s gold processing facilities. The terms of these contracts are within industry norms. A new electricity supply arrangement expected to commence in 2025, after construction and commissioning of required infrastructure, is also currently being finalised.

20 ENVIRONMENTAL STUDIES, PERMITTING, AND SOCIAL OR COMMUNITY IMPACT

The Higginsville-Lakewood Operations (HLO) is a multi-deposit operating mine with two gold mills that are in possession of all required permits. Environmental permitting and compliance requirements for mining and processing is the responsibility of Karora. HLO covers over 1,900 km² and has a significant disturbance footprint including tailings storage facilities, two operating mills, open pits, underground mines and haul roads.

Karora recently obtained the necessary environmental approvals to build a new tailings storage facility (TSF 2) for the Lakewood Mill and increase the annual plant throughput capacity.

20.1 HIGGINSVILLE GOLD OPERATIONS

20.1.1 Environmental Studies

Karora and the previous operators of HGO have undertaken numerous flora, fauna and vegetation surveys. There is a wealth of baseline data for vegetation and fauna communities in the vicinity of the Higginsville Mill. No rare or endangered species were identified that would be impacted by the construction and operation of the process plant. No Priority Species as defined by the Department of Climate Change, Energy, the Environment and Water (DCCEE) in the 'Threatened Species Action Plan 2022-2032' were located during the surveys. Some conservation significant fauna species occur within the local region. Prior to Karora undertaking any clearing activities, areas are targeted for the following:

- A grid search for Malleefowl and their breeding mounds within suitable habitat;
- Inspection of large hollow bearing trees; and
- Personnel are made aware of the presence of Carpet Pythons so that they can be relocated to suitable habitat.

The mining proposal for the expansion of tailings storage facilities at Higginsville required the following studies to be undertaken:

- An Interpretation of the Moving Loop Electromagnetic Survey using the Loupe System (2020) prepared by Newexco.
- Higginsville TSF2-4 Seepage Recovery Investigation (2020) prepared by Rockwater Hydrogeological and Environmental Consultants.

20.1.2 Required Permits and Status

A licence under the *Environmental Protection Act 1986* (EP Act) is required to operate certain industrial premises, known as 'prescribed premises'. In addition, a works approval is required for any work or construction that will cause the premises to become prescribed premises, or for work or construction which may cause, or alter the nature or volume of, emissions and discharges from an existing prescribed premises. Key licences and approvals for the operation of the Higginsville Mill are listed in Table 20-1.

Table 20-1 Summary HGO key licence and approvals

Reference	Approval	Issuer	Date Commenced	Expiry Date
L9155/2018/1 (Higginsville)	Licence relating to category 5 - Processing or beneficiation of metallic or non-metallic ore, 06 - mine dewatering, 054 - sewerage facility operations and 64 – Class I or II putrescible landfill	DWER	2018-09-18	2024-09-17
GWL 160795(8) (Higginsville)	Licence to take water under section 5C of the <i>Rights in Water and Irrigation Act 1914</i> (WA). Annual water entitlement 3,150,000 kL for the purpose of mineral processing, dewatering and dust suppression.	DER	2021-03-16	2029-05-05
CPS8152/4 (Higginsville)	Clearing of Native Vegetation for the purpose of mineral production and associated activities of up to 1,082.81 hectares	DMIRS	2018-10-17	2025-07-31

The HGO licences, issued under the EP Act (Part V), provide for the processing and beneficiation of metallic and non-metallic ore up to 1.5 Mtpa. Conditions such as groundwater level and limits, monitoring, discharge and reporting requirements are set in the licences.

Karora amalgamated several licences to take water in 2020 to reduce regulatory commitments and reporting requirements. There was a total of nine active permits in place around HGO, and these have been reduced to five active permits. The primary HGO groundwater licence has an allocation of 3,150 ML/a and allows for the dewatering of the Chalice open pit. The water is pumped 20 km to the Higginsville Mill, with short-term storage available in Aphrodite Pit. The HGO groundwater licence allows for dewatering of open pits and underground operations in close proximity to the Higginsville Mill.

Karora also amalgamated five active native vegetation clearing permits in 2020 to a single permit for HGO. CPS8152/4 permits the clearing of up to 1,000 ha of native vegetation and includes the open-cut pits Mouse Hollow and Pioneer, and the Two Boys underground mine. The clearing permit was amended in early 2023 to include the footprint for the proposed TSF 5. CPS8152/4 now permits the clearing of 1,082.81 ha.

20.1.2.1 Mining Proposals and Mine Closure Plans

There have been numerous Mining Proposals (MP) and Mine Closure Plans (MCP) approved and registered as belonging to the HGO. An application for a Mining Lease or the proposed mining of a new deposit must be accompanied by a mineralisation report or an MP and MCP in accordance with the Mining Act. A Mining Lease, MP and MCP are required prior to carrying out mining activities on a site.

The following approvals have been issued by DMIRS to support current mining operations:

- Government of Western Australia, Department of Mines, Industrial Regulation and Safety, approval under the *Mining Act 1978* – Mining Proposal for TSF2-4 Stage Lift (Reg ID: 89038);

- Government of Western Australia, Department of Mines, Industrial Regulation and Safety, approval under the *Mining Act 1978* – Mining Proposal for Baloo & Eundynie (Reg ID: 101748);
- Government of Western Australia, Department of Mines, Industrial Regulation and Safety, approval under the *Mining Act 1978* – Mining Proposal for Spargos Reward open pit & underground (Reg ID: 113402);
- Government of Western Australia, Department of Mines, Industrial Regulation and Safety, approval under the *Mining Act 1978* – Mining Proposal for Pioneer (Reg ID: 116335); and
- Government of Western Australia, Department of Mines, Industrial Regulation and Safety, approval under the *Mining Act 1978* – Higgsville Mine Closure Plan (Reg ID: 88901).

The Higgsville MCP (Reg ID:88901)—dated August 5, 2020, approved on July 5, 2021—is the most extensive as it covers several mining areas including Higgsville, Chalice, Lake Cowan, Paleochannel and Mt Henry areas. Karora completed the triennial revision of the Higgsville MCP in 2023 as required by tenement conditions. The MCP is currently under assessment with DMIRS. DMIRS requires that the MCP is updated on a regular basis to demonstrate preparedness for closure of the project.

20.1.2.2 Aboriginal Heritage Act 1972

There are a number of Aboriginal sites within the HGO tenements, as documented in the Government of Western Australia's Aboriginal Heritage Inquiry System (AHIS). The Department of Planning, Lands and Heritage preserves all Aboriginal sites in Western Australia whether or not they are registered. Aboriginal sites may exist that are not recorded on the register.

Ethnographic and archaeological surveys were commissioned over the HGO prior to it being developed and mined. No sites of ethnographic or archaeological significance were recorded that would impact on the operation of the Higgsville Mill.

Heritage protection and mining agreements are in place with the Ngadju Native Title Aboriginal Corporation (Ngadju), the traditional owners at HGO.

20.1.3 Environmental Aspects, Impacts and Management

From April 2016 to January 2019, under operation of the previous owners, HGO went through a period of non-compliance. The non-compliance related to high standing water levels in a number of monitoring boreholes adjacent to active tailings storage facilities (TSFs 1, 2, 3 and 4). In 2020, Karora applied to recommission TSFs 2–4 to provide a further five years of tailings storage capacity under the current production rate at HGO. Studies were undertaken on the hydrogeology beneath the tailings facility to develop a seepage recovery plan that would ensure the facility remained compliant with the Premises Licence conditions, if the facility were to be recommissioned. DMIRS accepted the groundwater recovery plan and approved the mining proposal that included an initial raise of TSF 2 and three subsequent stage raises of TSFs 2, 3 and 4 into one supercell. DWER has also issued an amended Premises Licence that approved the recommissioning of the facility.

The HGO site has a detailed Environmental Management Plan that includes site specific processes and procedures. The site has a detailed record of the applicable legislation and legal requirements as well as various management and monitoring programs required to ensure compliance with legal and legislative requirements.

Karora has in place the appropriate processes and plans to meet its environmental requirements and commitments.

20.1.4 Mining Rehabilitation Fund

The MRF is a pooled fund, established under the *Mining Rehabilitation Fund Act 2012* (MRF Act), that is used to rehabilitate abandoned mine sites in Western Australia. All tenement holders (with the exception of tenements covered by State Agreements not listed in the *Mining Rehabilitation Fund Regulations 2013* are required to participate in the MRF. The HGO tenements are subject to the MRF Act.

A 1% levy is paid annually by tenement. HGO is up to date with payment to end of June 2023. The next annual payment is due in July 2024. Annual MRF contributions payments are approximately A\$320k.

Karora recently completed a full review of the closure cost models to align with the International Accounting Standard IAS 137 – Provisions, Contingent Liabilities and Contingent Assets. HGO's closure cost is estimated at approximately A\$30M.

20.1.5 Social and Community

The Higgsville region has a substantial history of exploration and mining. Gold was first discovered in 1905 with gold mining operations continuing sporadically throughout the 20th century and then recommencing in earnest in 1989. Additional mining activities included salt mining at Lake Lefroy during the 1960s to 1980s, and nickel mining from the 1970s to the present. HGO operates within an environment of strong local community support.

The nearest town to HGO is Norseman, with a population of 562 (2021 Census), 52 km south of the Higgsville Mill. Kambalda, with a population of 1,666 (2021 Census), is located 68 km via the Goldfields Highway to the north.

Kalgoorlie-Boulder has a population of 29,306 (2021 Census) and is located 60 km north of Kambalda. Kalgoorlie is the regional centre for the Eastern Goldfields and is a regional hub for transport, communications, commercial activities and community facilities.

The current workforce at HGO (Karora employees and contractors) comprises 77 personnel. All are accommodated on site during their rostered-on periods. Most workers permanently reside in Perth and FIFO from Perth to HGO on either an 8 days-on/6 days-off, 12 days-on/9 days-off or 14 days-on/7 days-off rotation. The FIFO workers are supplemented by workers who reside in regional towns such as Norseman, Kambalda, Kalgoorlie and Esperance, Western Australia.

The nearest port is Esperance, 260 km south of HGO.

20.2 LAKEWOOD OPERATIONS

20.2.1 Environmental Studies

The LKO is located within a historical gold treatment area adjacent to the famous Golden Mile. The site and its immediate surrounds have been subject to extensive historic disturbance from the early 1900s including timber cutting, townsite development, mining and tailings stockpiling. The main access to the Lakewood Mill is from the Goldfields Highway via the public Mount Monger Road and gazetted Lakewood Gold Processing Facility Access Road. Given that the area has been heavily disturbed by historic mining operations, the 'regrowth' present around Lakewood does not represent the pre-disturbance vegetation communities.

20.2.1.1 Soils and Flora

Soils in the immediate project area have been heavily disturbed by prior mining activity and have been contaminated by the historical storage of tailings known as 'slime dumps'. These tailings were reprocessed at Lakewood in the early 1990s. Surface soils for the majority of the proposed TSF 2 site are salt scalded and contaminated with historical tailings. A soil assessment was undertaken by Outback Ecology in 2013. The assessment was completed in the proposed TSF 2 area. This area was classed as silty clay loam to medium clay. Most soils within this area were identified as being non-dispersive; however, all samples contained high clay content and were extremely saline.

The predominant vegetation communities are comprised of halophytic shrubland with all overstorey species removed by historical clearing. The vegetation condition has been assessed as degraded to completely degraded within areas of future development for TSF 2.

20.2.1.2 Fauna

G&G Environmental Pty Ltd were commissioned by Silver Lake Resources in 2009 to undertake a Desktop Fauna Survey of tenement M26/242. The 2009 Assessment noted that tenement M26/242 has been impacted by extensive clearing and mining activities on the site and surrounds over the past 100 years, resulting in the complete removal/destruction of habitat required to support most of these fauna species. The resultant vegetation generally comprises sparse low chenopod shrubland and vegetation dominated by old man saltbush. The dominant vegetation of the Coolgardie and Murchison area (eucalypt woodland) that commonly supplies habitat for tree nesting reptiles and birds has been cleared. As a result of the altered nature of the site with significantly degraded vegetation and general lack of habitat in good condition, it is considered unlikely that the project area supports fauna assemblages of conservation significance.

20.2.2 Hydrology

The LKO site lies directly in the flow path of an upstream catchment area of approximately 114 km². Based on a review of current aerial photography, approximately 11 km² of the contributing catchment area is assumed to be internally draining TSFs and waste rock landforms (WRL) from the nearby mining operations (TTC, 2021).

Runoff from the Lakewood Mill enters Hannan Lake approximately 2 km south of the site. Diversion drains are required at Lakewood to manage potential floodwaters. The proposed diversion drain around the western and southern sides of TSF 2 has a base width of 3 m and a nominal depth of approximately 1 m.

The production bores WB01, WB02 and WB03 intersected about 5 m to 10 m of ferruginous sandy gravel, further intersecting 20 m to 30 m of Cainozoic alluvium, comprising clays, sandy clays and gravelly clays. Beneath the Cainozoic alluvium, the bores intersected 10 m to 20 m of saprolitic clays and saprock. This zone provided the primary inflow for WB01 and WB03 (base of the saprolitic zone for WB03). Beneath the saprock, the bores intersected fresh felsic porphyry, understood to be the Mulgabbie Formation.

The groundwater quality around Lakewood has total dissolved solids (TDS) ranging between 39,000 mg/L and 112,000 mg/L with a pH in the range of 3–6.5. Kalgoorlie's Fimiston Operations (upgradient of the Lakewood Mill), completed an Acid Drainage Risk Evaluation as part of a Public Environmental Review in 2006. It was noted that groundwater in monitoring bores around the Fimiston TSF has a low pH of circa 3–4, and that there is evidence of the occurrence of acid

mine drainage in the Kalgoorlie region, primarily associated with the presence of Black Flag Shales in WRLs. The acidic nature of groundwater was also thought to potentially be a result of dry-land salinity sulphidic acidity from oxidising monosulphides within the regolith profile.

20.2.3 Required Permits and Status

20.2.3.1 Permitting History

The Lakewood area has been used for tailings storage since the early 1900s with most of the tailings derived from the processing of gold bearing ore from the Golden Mile. These tailings dumps (historically called slime dumps) were a significant source of dust in the Kalgoorlie-Boulder community. In the late 1980s, the retreatment of the residual gold bearing tailings was planned as part of the Fimtails and Kaltails Projects.

The Lakewood (Fimtails) Treatment Plant and associated Tailings Storage Facility was initially constructed in 1989 (approved via NOI 213) and operated on a periodic basis throughout the 1990s. Historic tailings from the Kalgoorlie-Boulder area were retreated using the CIL process between 1989 and 1991. The Lakewood Plant was placed into care and maintenance from August 1991 until 1995.

Roehampton Resources NL purchased the Lakewood Plant in 1995 and upgraded the treatment facility. The plant completed campaign processing for a number of years until 1997. Refurbishment of the Lakewood Plant was undertaken in 2000 by Lakewood Mill Pty Ltd (approved via NOI 3589), allowing for the recommencement of processing operations between 2001 until 2007. The plant was operated on a campaign basis until November 2007, including the retreatment of residual tailings on agreement with Normandy Kaltails.

In 2007, the Lakewood Plant was purchased by Silver Lake Resources and underwent a number of refurbishment projects until 2011. Golden Mile Milling Pty Ltd purchased Lakewood Gold Processing Facility in 2015 and steadily increased the production rate up to a throughput around 0.7 Mtpa to 0.9 Mtpa. Karora purchased the Lakewood Operations from GMM on July 27, 2022.

DMIRS approved the Lakewood Gold Processing Facility Mining Proposal (Reg ID: 111925) on March 16, 2023. The mining proposal granted approval to construct TSF 2 in accordance with the revised design and to increase the production rate up to 1.2 Mtpa. DWER granted the Works Approval to construct TSF 2 and the process plant upgrades on January 20, 2023.

20.2.3.2 Environmental Protection Act 1986

20.2.3.2.1 Part IV

Part IV of the EP Act applies to 'environmentally significant proposals'. The term 'environmentally significant' is not defined in the EP Act, and is instead described in the *Environmental Impact Assessment (Part IV Divisions 1 and 2) Administrative Procedures 2012*. The Lakewood Mill has not triggered any criteria to be separately assessed under Part IV of the EP Act.

20.2.3.2.2 Part V - Works Approvals and Licences

The DWER regulates industrial emissions and discharges to the environment through a works approval and licensing process, under Part V of the EP Act. Industrial premises with potential to cause emissions and discharges to air, land or water are known as 'prescribed premises' and trigger regulation under the Act. Prescribed premises categories are outlined in Schedule 1 of the *Environmental Protection Regulations 1987*.

The Act requires a works approval to be obtained before constructing a prescribed industrial premise and makes it an offence to cause an emission or discharge unless a licence or registration is held for the premises. In effect, a works approval enables the construction and licences the operation of a prescribed premises in accordance with set conditions.

GMM was issued an amended Prescribed Premises Licence (L9024/2018/1) for the Lakewood GPF on October 9, 2020. Licence L9024/2018/1 is valid from May 21, 2020 to May 20, 2030. The approved licence categories for the Lakewood Mill are as follows:

- Category 5: Processing or Beneficiation of Ore (900,000 tonnes per year); and
- Category 61: Liquid Waste Facility (1,300 tonnes per year).

This licence has been transferred to Lakewood Mining Pty Ltd. DWER granted Karora the Works Approval (W6719/2022/1) to undertake construction of the proposed TSF 2.

20.2.3.2.3 Part V – Native Vegetation Clearing Permits

Under the EP Act, clearing of native vegetation is an offence unless it is done under the authority of a Clearing Permit or an exemption applies. Clearing Permits either allow the clearing of a specific area (Area Permit) or for a specific purpose (Purpose Permit).

The Native Vegetation Clearing Permit (CPS 9743/1) was granted on June 23, 2022 and is valid for a period of two years. No conservation significant species were recorded within the areas to be cleared at Lakewood for the proposed TSF 2.

20.2.3.3 Mining Act 1978

Environmental aspects of mining and mineral processing (and related infrastructure) are regulated under the Mining Act. DMIRS approved the Lakewood Gold Processing Facility Mining Proposal (Reg ID: 111925) on March 16, 2023. The mining proposal granted approval to construct TSF 2 in accordance with the revised design and to increase the production rate up to 1.2 Mtpa.

20.2.3.4 Rights in Water and Irrigation Act 1914

Construction of bores, taking of surface water and groundwater and implementation of works that may affect watercourses are generally regulated under the *Rights in Water and Irrigation Act 1914*. However, special administrative and policy arrangements have been agreed between DMIRS and DWER, such that some mining activities that would normally require formal DWER approval are exempt from DWER permitting and are instead managed through the instrument of a mining proposal approved by the DMIRS (DMIRS and DWER, 2021). Licensing exemptions do not apply to taking of water.

Karora holds two Licences to Take Water GWL 203328(2) and GWL 203329(2) for a combined abstraction of 900,000 kL at Lakewood for water supply. Lakewood also has an agreement with KCGM for the supply of process water from their Fimiston mining operations.

20.2.3.5 Aboriginal Heritage Act 1972

There have been two recorded ethnographic surveys and one archaeological survey which covered the Lakewood mining lease areas. The buffer areas of two registered Aboriginal Sites intersect with the southern portion of L26/234 that provides access to a borefield. No disturbance to these Aboriginal Sites is required to maintain water supply for processing at Lakewood.

20.2.4 Environmental Aspects, Impacts and Management

Lakewood Operations is relatively small in size with a limited disturbance footprint and placed within the foothills of the KCGM waste dumps. Groundwater mounding around the TSFs is the largest environmental concern at Lakewood. Karora has maintained the existing seepage recovery network around TSF 1 and completed the installation of ten new monitoring bores and five seepage recovery bores around the proposed TSF 2. The seepage recovery bores will be equipped with pumps once TSF 2 construction has been completed. The information reviewed suggests that the key environmental aspects requiring management effort are as follows:

- Water management; and
- Mine rehabilitation and closure.

Karora has disclosed that there are no other known outstanding significant environmental issues.

20.2.4.1 Mine Rehabilitation and Closure

Under the Mining Act, responsibility for mine rehabilitation and closure lies with the tenement holder; as such, Karora, as the new tenement holder, is responsible for the rehabilitation of the disturbed area associated with the Lakewood Mill. No significant rehabilitation activities are possible while the tailings storage facilities are active. The opportunity may arise in the future to coordinate the closure of the site in synergy with KCGM's operations and waste dump expansion.

20.2.5 Mining Rehabilitation Fund

The Lakewood tenements are subject to the MRF Act (refer Section 20.2.4).

A 1% levy is paid annually by tenement. Lakewood is up to date with payment to end of June 2023. The next annual payment is due in July 2024. Annual MRF payments are approximately A\$33k.

As part of Karora's recent review of the closure cost models, a new model was completed for Lakewood to align with the International Accounting Standard IAS 137 – Provisions, Contingent Liabilities and Contingent Assets. LKO's closure cost is estimated at approximately A\$8.7M.

20.2.6 Social and Community

Lakewood is approximately 4 km southeast of the City of Kalgoorlie-Boulder which is the nearest occupied townsite.

Kalgoorlie is the regional centre for the Eastern Goldfields and is a regional hub for transport, communications, commercial activities and community facilities. Kalgoorlie-Boulder has a population of 29,306 (2021 Census)

The majority of the current workforce of 22 personnel are accommodated within the Kalgoorlie-Boulder-Kambalda region.

The nearest port is Esperance, 390 km south of Kalgoorlie.

21 CAPITAL AND OPERATING COSTS

Capital and operating costs are derived from current site costs, in addition to recent supplier quotations. As such, these costs are well understood and allow enough detail for Mineral Reserves to be declared.

21.1 HIGGINSVILLE CENTRAL

21.1.1 Trident Underground

21.1.1.1 Capital Costs

As a historic gold mine but with very good existing development and other infrastructure, major infrastructure capital is already in place although additional allowances were made for piping, ventilation, dewatering and power distribution underground. Trident will therefore have a reasonably low initial capital outlay (Table 21-1) and most of the costs will be ongoing capitalised costs and some sustaining capital cost.

The sustaining capital expenditure is allocated for on-going capital development, mining equipment costs (replacements, rebuilds and major overhauls), and other underground infrastructure refurbishment. Sustaining capital requirements also include extensions to the ventilation, pumping, and electrical networks that follow capital decline development as the mine goes deeper. This is in addition to sustaining costs associated with ongoing mill infrastructure maintenance as required which are included in operating cost details. The annual sustaining capital costs are detailed in Table 21-2.

Table 21-1 Initial project capital cost

	Units	Total	Year 1	Year 2	Year 3
Plant and Equipment	\$A M	3.0	3.0	0.0	0.0
Capital Development	\$A M	9.6	9.6	0.0	0.0
Total	\$A M	12.6	12.6	0.0	0.0

Table 21-2 Sustaining capital cost

	Units	Total	Year 1	Year 2	Year 3
Plant and Equipment	\$A M	0.4	0.3	0.1	0.0
Capital Development	\$A M	5.0	1.7	3.0	0.4
Total	\$A M	5.4	2.0	3.0	0.4

21.1.1.2 Operating Costs

Karora has an established operation at Beta Hunt and therefore has a good understanding of its costs and has a functioning cost management system considered for Trident. An independent mining cost model was, however, developed for the Trident planning and compared to the typical costs observed at Beta Hunt. Operating cost inputs are based on simulated and then benchmarked actual costs in addition to recent supplier quotes as obtained for Beta Hunt. Processing Costs include an allowance for sustaining capital and tailing storage on a dollar per tonne basis.

The operating costs are detailed in Table 21-3.

Table 21-3 Site operating costs

Operating Costs	Units	Total	Year 1	Year 2	Year 3
Mining Operating Cost	\$A M	45.2	11.8	22.4	11.0
Processing Costs	\$A M	15.4	3.7	8.2	3.5
Royalties	\$A M	5.8	1.3	3.0	1.5

21.1.1.3 Closure

Trident's closure involves closing off the portal and other ventilation access holes. These will be done by cement plugging the vertical holes and a locked gate located at the Trident portal. Some other infrastructure should also be removed, but the closure cost will be shared by other deposits. An estimate of the closure cost for the Trident underground mine is approximately A\$100k.

As per Section 20.1.4, Karora recently completed a full review of the closure cost models to align with the International Accounting Standard IAS 137 – Provisions, Contingent Liabilities and Contingent Assets. HGO's closure cost is estimated at approximately A\$30M.

21.1.2 Open Pits

21.1.2.1 Capital Costs

As all the Higginsville Central open pit operations are relatively small and planned for contract mining, there are no specific capital costs associated with each deposit/open pit.

21.1.2.2 Operating Costs

Karora has established open pit (contract mining) operations at Higginsville and therefore has a good understanding of its costs and has a functioning cost management system.

Each open pit used/assumed the typical mining contract rates as they are all located in the same area and have reasonably similar rock and ore properties. The contract mining rates used to calculate the mining costs are currently used at Pioneer (Table 21-4).

Table 21-4 HGO Central operating costs

	Units	Total	Mitchell	Pioneer
Mining Costs	A\$ M	34.1	15.2	18.9
Haulage Costs	A\$ M	1.9	0.7	1.2
Processing Costs	A\$ M	14.7	6.9	7.8
Royalties	A\$ M	4.3	2.4	1.9

21.1.2.3 Closure

An allowance of \$460,000 has been allocated toward the mining contractor completing rehabilitation at Pioneer including final waste dump profiling.

An allowance of \$1,030,000 has been allocated toward the mining contractor completing rehabilitation at Mitchell including final waste dump profiling.

As per Section 20.1.4, Karora recently completed a full review of the closure cost models to align with the International Accounting Standard IAS 137 – Provisions, Contingent Liabilities and Contingent Assets. HGO's closure cost is estimated at approximately A\$30M.

21.2 HIGGINSVILLE GREATER

21.2.1 Chalice Underground

21.2.1.1 Capital Costs

As a historic gold mine but with very good existing development and other infrastructure, major infrastructure capital is already in place although additional allowances were made for piping, ventilation, dewatering and power distribution underground. Chalice will therefore have a reasonably low initial capital outlay and most of the costs will be ongoing capitalised costs and some sustaining capital cost (Table 21-5).

The sustaining capital expenditure is allocated for on-going capital development, mining equipment costs (replacements, rebuilds and major overhauls), and other underground infrastructure refurbishment. Sustaining capital requirements also include extensions to the ventilation, pumping, and electrical networks that follow capital decline development as the mine goes deeper. This is in addition to sustaining costs associated with ongoing mill infrastructure maintenance as required which are included in operating cost details. The annual sustaining capital costs per annum are detailed in Table 21-6.

Table 21-5 Initial project capital cost

	Units	Total	Year 1	Year 2	Year 3
Plant and Equipment	\$A M	5.6	5.6	0.0	0.0
Capital Development	\$A M	5.5	5.5	0.0	0.0
Total	\$A M	11.0	11.0	0.0	0.0

Table 21-6 Sustaining capital cost

	Units	Total	Year 1	Year 2	Year 3
Plant and Equipment	\$A M	0.2	0.1	0.1	0.1
Capital Development	\$A M	7.1	3.0	3.7	0.4
Total	\$A M	7.3	3.1	3.8	0.5

21.2.1.2 Operating Costs

Karora has an established operation at Beta Hunt and therefore has a good understanding of its costs and has a functioning cost management system considered for Chalice. An independent mining cost model was, however, developed for the Chalice planning and compared to the typical costs observed at Beta Hunt. Operating cost inputs are based on simulated and then benchmarked actual costs in addition to recent supplier quotes as obtained for Beta Hunt. Processing costs include an allowance for sustaining capital and tailing storage on a dollar per tonne basis (Table 21-7).

Table 21-7 Operating costs

	Units	Total	Year 1	Year 2	Year 3
Mining Operating Cost	\$A M	51.2	17.6	22.5	11.2
Haulage Costs	\$A M	3.4	0.8	1.8	0.8
Processing Costs	\$A M	27.5	6.2	14.6	6.7
Royalties	\$A M	7.1	1.4	3.8	1.9

21.2.1.3 Closure

Chalice mine closure involves closing off the portal and other ventilation access holes. These will be done by cement plugging the vertical holes and a locked gate located at the Chalice portal. Some other infrastructure should also be removed, but the closure cost will be shared by other deposits. An estimate of the closure cost for the Chalice underground mine is approximately A\$100k.

As per Section 20.1.4, Karora recently completed a full review of the closure cost models to align with the International Accounting Standard IAS 137 – Provisions, Contingent Liabilities and Contingent Assets. HGO's closure cost is estimated at approximately A\$30M.

21.2.2 Spargos Underground

21.2.2.1 Capital Costs

Major capital costs include the dewatering pipeline to Beta Hunt, primary ventilation fans, primary pumps, refuge chambers, electrical infrastructure and office blocks/ablutions (Table 21-8).

The sustaining capital expenditure is allocated for on-going capital development, mining equipment costs (replacements, rebuilds and major overhauls), and other underground infrastructure refurbishment. Sustaining capital requirements also include extensions to the ventilation, pumping, and electrical networks that follow capital decline development as the mine goes deeper. This is in addition to sustaining costs associated with ongoing mill infrastructure maintenance as required which are included in operating cost details. The sustaining capital costs per annum are detailed in Table 21-9.

Table 21-8 Initial project capital cost

	Units	Total	Year 1	Year 2	Year 3
Plant and Equipment	\$A M	6.6	6.6	0.0	0.0
Capital Development	\$A M	14.9	14.9	0.0	0.0
Total	\$A M	21.4	21.4	0	0

Table 21-9 Sustaining capital cost

	Units	Total	Year 1	Year 2	Year 3
Plant and Equipment	\$A M	1.3	0	0.3	1.0
Capital Development	\$A M	29.3	3.2	20.2	5.9
Total	\$A M	30.6	3.2	20.6	6.8

21.2.2.2 Operating Costs

Karora has an established operation at Beta Hunt and therefore has a good understanding of its costs and has a functioning cost management system considered for Spargos. An independent mining cost model was, however, developed for the Spargos planning and compared to the typical costs observed at Beta Hunt. Operating cost inputs for underground mining at Spargos are based on reputable underground mining contractor's indicative rates which were source specifically for Spargos. Other costs have been derived from supplier quotes as obtained for Beta Hunt. Processing costs include an allowance for sustaining capital and tailing storage on a dollar per tonne basis (Table 21-10).

Table 21-10 Operating costs

	Units	Total	Year 1	Year 2	Year 3
Mining Operating Cost	\$A M	39.9	8.5	13.8	17.7
Haulage Costs	\$A M	3.3	0.6	1.2	1.5
Processing Costs	\$A M	15.5	2.7	5.9	7.0
Royalties	\$A M	3.1	0.5	1.4	1.1

21.2.2.3 Closure

As per Section 20.1.4, Karora recently completed a full review of the closure cost models to align with the International Accounting Standard IAS 137 – Provisions, Contingent Liabilities and Contingent Assets. HGO's closure cost is estimated at approximately A\$30M, of which A\$1.2M is estimated for Spargos.

21.2.3 Mt Henry Project

21.2.3.1 Capital Costs

An estimate has been made of the initial site establishment capital requirements for the Mt Henry Project, totalling A\$6M. This includes an allowance for the development of a mine haul road from Selene to the proposed ore stockpiling area at Mt Henry. It is assumed that the other site development works (i.e. stripping, clearing, roadbuilding etc.) can be completed during the period in which they are required, and do not require to be brought forward to Year-1 as a capital expense.

21.2.3.2 Operating Costs

A detailed mine operating cost model has been built up for the MHP operation from first principles. Table 21-11 details the LOM operating cost estimate on a total cost and dollar per tonne mined cost basis.

Table 21-11 Mt Henry Project mining costs

	\$/t mined	Project Total (\$M)	Year 1 (\$M)	Year 2 (\$M)	Year 3 (\$M)	Year 4 (\$M)	Year 5 (\$M)	Year 6 (\$M)	Year 7 (\$M)
Load and Haul	2.42	142.3	49.5	40.3	21.7	11.2	8.6	5.9	5.1
Ancillary Equipment	0.52	30.8	11.5	9.0	4.6	2.2	1.6	1.1	0.9
Clearing and Rehab	0.02	1.4	0.5	0.4	0.2	0.1	0.1	0.1	0.0
GC	0.01	0.7	0.1	0.1	0.1	0.1	0.1	0.1	0.1
Drill and Blast	1.06	62.2	22.5	17.3	9.1	4.8	3.7	2.6	2.2
Dewatering	0.04	2.4	0.9	0.7	0.3	0.2	0.1	0.1	0.1
Contractor Costs	0.46	26.8	10.0	7.4	3.9	2.0	1.5	1.1	0.9
Owner Costs	0.27	15.8	5.9	4.4	2.3	1.2	0.9	0.6	0.5
Total Mining Cost	4.79	282.4	100.9	79.5	42.2	21.8	16.7	11.5	9.8

The cost model assumes haulage to and processing at the Higginsville Mill. Haulage costs are sourced from actual site costs, adjusted for the relevant haulage length. Processing costs are taken from site forecasts. It is important to note, that Karora plans to execute a Power Purchase Agreement (PPA) for the supply of mains power to HGO. This should reduce processing costs via a reduction in power costs compared to recent operating history and the PPA has assumed

to be in place for the MHP cost model. Processing costs are inclusive of sustaining capital as well as an allowance for tailing storage (Table 21-12). State royalty of 2.5% and Native Title Royalty of 1% are applied.

Table 21-12 Mt Henry Project costs

	Unit	Project Total (\$M)	Year 1 (\$M)	Year 2 (\$M)	Year 3 (\$M)	Year 4 (\$M)	Year 5 (\$M)	Year 6 (\$M)	Year 7 (\$M)	Year 8 (\$M)
Total Mining Cost	A\$ M	282.36	100.9	79.5	42.2	21.8	16.7	11.5	9.8	-
Total Haulage Cost	A\$ M	108.30	10.7	16.0	16.0	16.0	16.0	16.0	16.0	1.5
Total Processing Cost	A\$ M	346.57	34.4	51.3	51.2	51.2	51.2	51.3	51.2	4.7
Total Royalties	A\$ M	30.53	3.2	4.2	4.5	4.4	4.5	4.7	4.6	0.4

21.2.3.3 Closure

The open pits closure cost simply involves dozing and profiling of the waste rock dumps a cost included in the waste cost detailed above.

As per Section 20.1.4, Karora recently completed a full review of the closure cost models to align with the International Accounting Standard IAS 137 – Provisions, Contingent Liabilities and Contingent Assets. HGO's closure cost is estimated at approximately A\$30M.

21.2.4 Other Open Pits

21.2.4.1 Capital Costs

As all the Higginsville Greater open pit operations are relatively small and planned for contract mining, there are no specific capital costs associated with each deposit/open pit.

21.2.4.2 Operating Costs

Karora has established open pit (contract mining) operations at Higginsville and therefore has a good understanding of its costs and has a functioning cost management system.

Each open pit used/assumed the typical mining contract rates as they are all located in the same area and have reasonably similar rock and ore properties. The contract mining rates used to calculate the mining costs are currently used at Pioneer (Table 21-13).

Table 21-13 HGO Central operating costs

	Units	Total	Atreides	Musket
Mining Costs	A\$ M	29.3	10.1	19.2
Haulage Costs	A\$ M	3.2	1.1	2.1
Processing Costs	A\$ M	12.7	6.4	6.3
Royalties	A\$ M	3.1	1.3	1.8

21.2.4.3 Closure

An allowance of \$281,000 has been allocated toward the mining contractor completing rehabilitation at Atreides including final waste dump profiling.

An allowance of \$1,125,000 has been allocated toward the mining contractor completing rehabilitation at Musket including final waste dump profiling.

As per Section 20.1.4, Karora recently completed a full review of the closure cost models to align with the International Accounting Standard IAS 137 – Provisions, Contingent Liabilities and Contingent Assets. HGO's closure cost is estimated at approximately A\$30M.

22 ECONOMIC ANALYSIS

22.1 CASH FLOW ANALYSIS

Karora is using the provision for producing issuers, whereby producing issuers may exclude the information required under Item 22 for Technical Reports on properties currently in production and where no material production expansion is planned.

The Mineral Reserve declaration for the Higginsville-Lakewood Operations is supported by a positive cash flow.

22.2 COMMENTS ON SECTION 22

An economic analysis was performed in support of estimation of Mineral Reserves. This indicated a positive cash flow using the assumptions and parameters detailed in this Technical Report.

23 ADJACENT PROPERTIES

23.1 ST IVES

The St Ives Gold Mine is owned by St Ives Gold Mining Company (SIGMC), a 100% Gold Fields Limited subsidiary company, and is located directly along strike to the northwest of HGO in the Norseman-Wiluna Belt. This broad structure is markedly linear with north-northwest trending strike-slip faults and other tectonic lineaments traceable for hundreds of kilometres, which disrupt the greenstone into fault-bounded domains. The generalised stratigraphic sequence is part of the Kambalda Domain and includes mafic-ultramafic units and felsic volcanic units which extend onto the HGO leases to the southwest.

Western Mining resumed gold mining at St Ives in 1981 and since then the operation has produced over 16 Moz of gold. Currently there are seven underground mines 16 open pits contributing to the Mineral Resource. The Mine operates a 4.7 Mtpa processing plant that consists of primary crushing, SAG/ball milling, gravity and leach/CIP circuits.

In 2023, SIGMC reported a Total Measured and Indicated Mineral Resource estimate of 10,312 kt grading 2.9 g/t Au for 964 koz contained gold and Total Inferred Mineral Resource of 11,303 kt grading 3.9 g/t for 1,432 koz contained gold as part of their 2022 Annual Mineral Resource and Mineral Reserve Statement (Gold Fields Limited, 2023) covering the St Ives Operation.

23.2 NORSEMAN

Pantoro Limited (Pantoro) owns the Norseman Gold Project. The Project covers 1,000 km² of prospective ground to the south and adjacent to HGO tenure at the southern end of the Norseman-Wiluna Greenstone Belt. Specifically, Karora's Mt Henry Project occurs directly along strike of existing mines owned by Pantoro. The project has produced over 5.5 Moz of gold historically (commenced in 1935) and currently has a Total Measured and Indicated Mineral Resource estimate of 26,276 kt grading 2.9 g/t Au for 2,453 koz contained gold and Total Inferred Mineral Resource of 19,305 kt grading 3.7 g/t for 2,294 koz contained gold (www.pantoro.com: ASX release, May 14, 2019). After a period on care and maintenance, the Norseman Operation recommenced in October 2022.

The Qualified Person has been unable to verify the information on these adjacent properties. This information is not necessarily indicative of the mineralization on the property that is the subject of the Technical Report.

Figure 23-1 Gold deposits adjacent and along strike of HGO highlighting the adjacent St Ives Gold and Norseman Gold Projects

Source: Karora

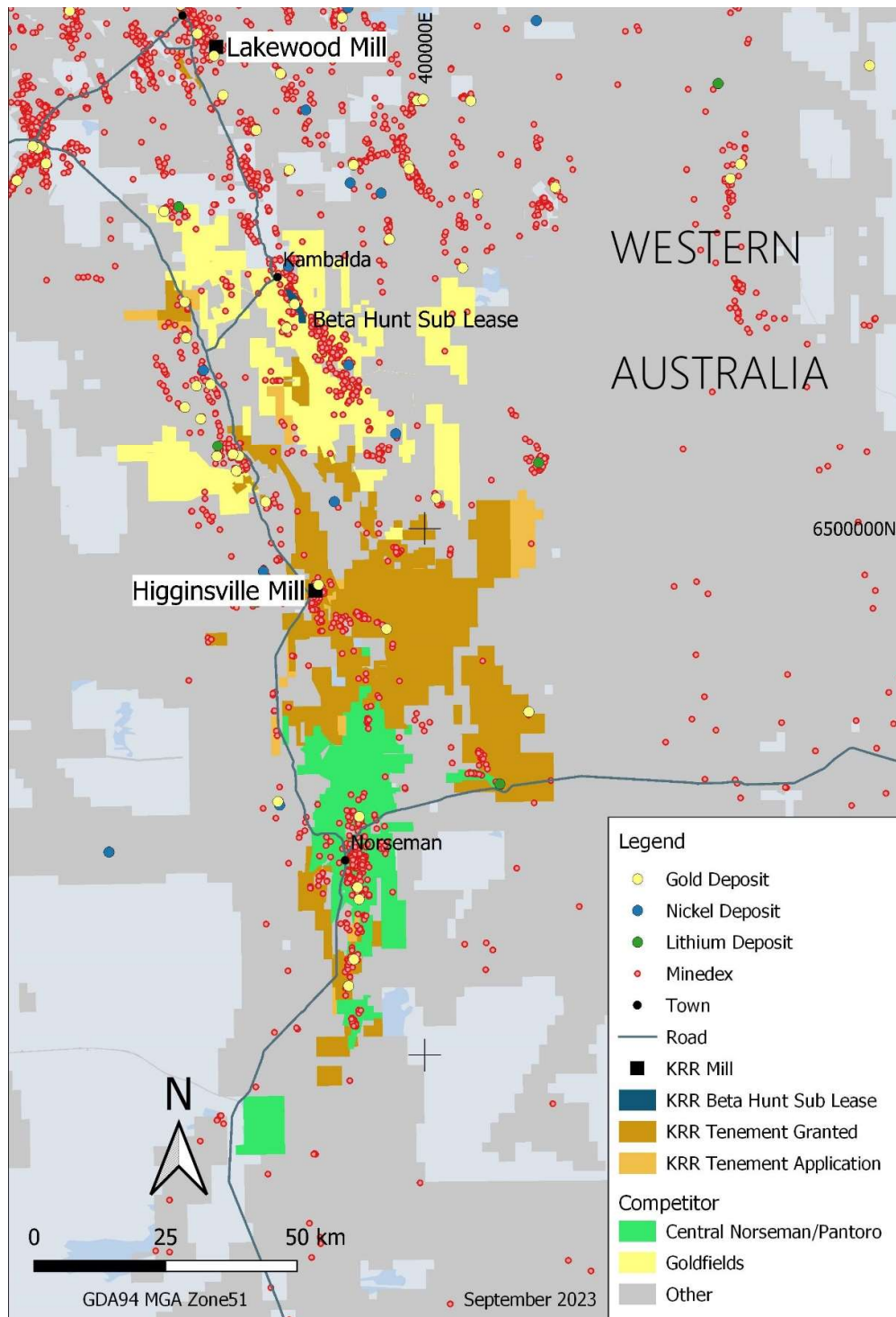

24 OTHER RELEVANT DATA AND INFORMATION

24.1 GOLD EXPLORATION POTENTIAL

HGO encompasses approximately 1,800 km² of the prospective Norseman-Wiluna greenstone belt, located between the world-class gold mining centres of St Ives (+16 Moz mined) and Norseman (6 Moz mined).

The HGO area also overlies three of the richest mineralised regional shear zones in the Eastern Goldfields – Boulder-Lefroy, Zuleika and Speedway (Figure 24-1). The Boulder Lefroy controls the Golden Mile deposit of Kalgoorlie (60 Moz mined) and the St Ives gold camp (16 Moz mined). The Invincible deposit which underpins the St Ives Operation is controlled by the poorly explored Speedway shear, while the Zuleika is associated with the Kundana and Mount Marion deposits to the north.

In the last 20 years, the HGO area has delivered significant discoveries: Trident in 2004 (1 Moz mined) and the Polar Bear deposits, including Baloo, in 2015. Trident was discovered testing down plunge extensions to a known deposit (Poseidon Sth) while Baloo was discovered by S2 using reconnaissance aircore. These discoveries highlight the potential for early stage exploration to deliver new discoveries in a 'mature' goldfield. The along strike structural corridor associated with the Baloo discovery, known as the Sleuth Trend, remains relatively unexplored due to it being largely concealed by the shallow salt lake sediments.

HGO has a large number of prospects at various stages of progress to deliver a new resource. The Exploration team at HGO has used a milestone-based system to rank and target these prospects (Figure 24-2). Very little greenfields exploration has occurred in recent years with drilling focusing on upgrading existing resources.

Exploration drilling planned for 2024 includes follow up aircore, RC and diamond drilling on Lake Cowan testing structural and geochemical targets on the Sleuth Trend (Figure 24-3) identified from the recently completed desktop Integrated Geological Interpretation of the Sleuth Trend and Exploration Targeting Study completed by CSA Global (2021).

Figure 24-1 Gold deposits adjacent and along strike of Higginsville highlighting Regional Shear Zones—1VD aeromagnetic image Source: Karora

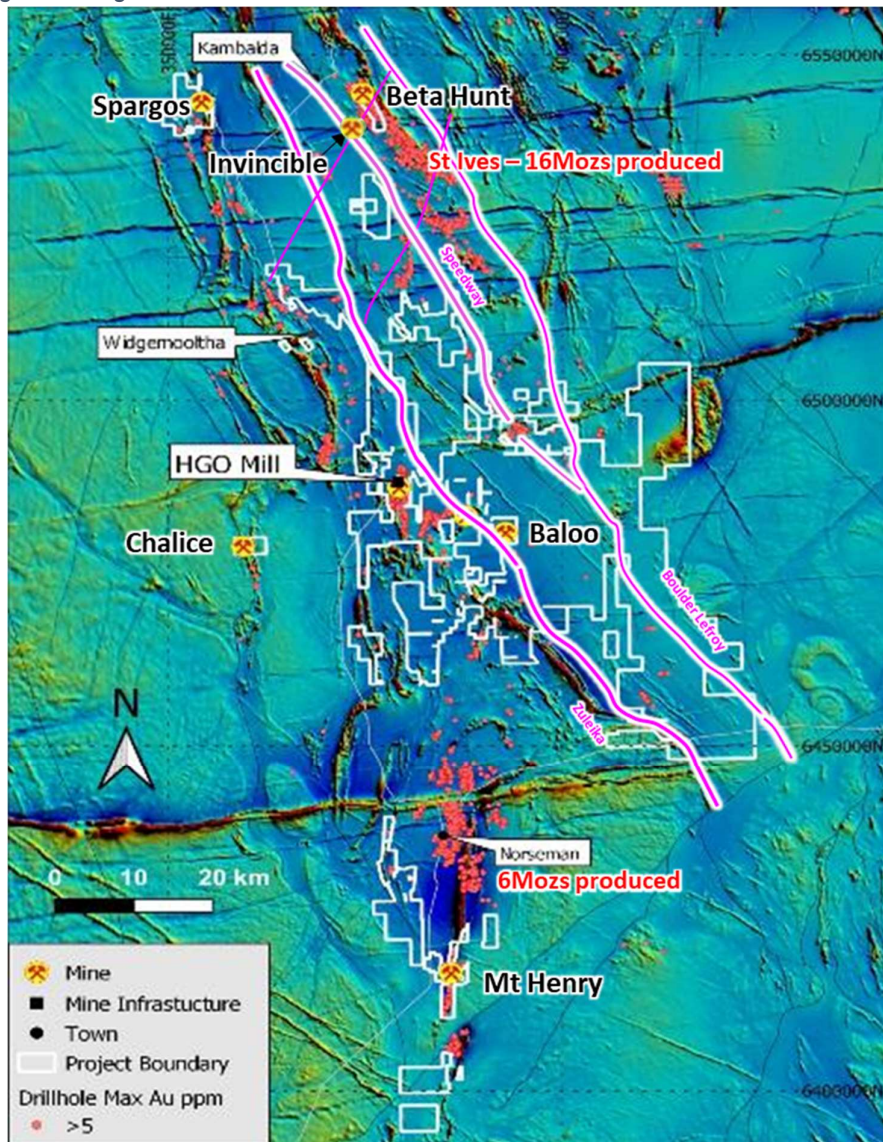

Figure 24-2 HGO exploration target pipeline

Source: Karora

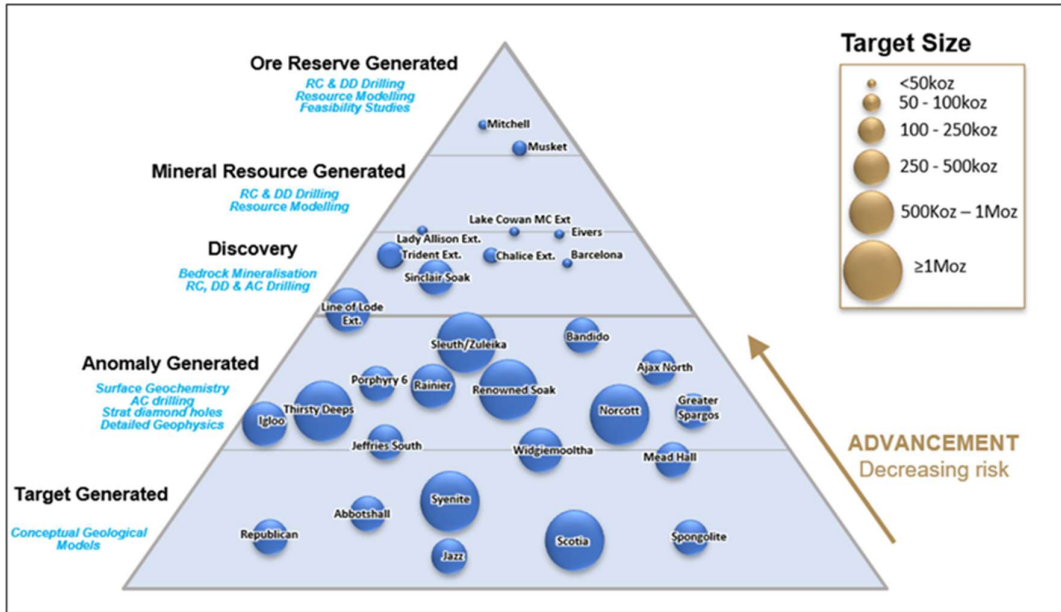
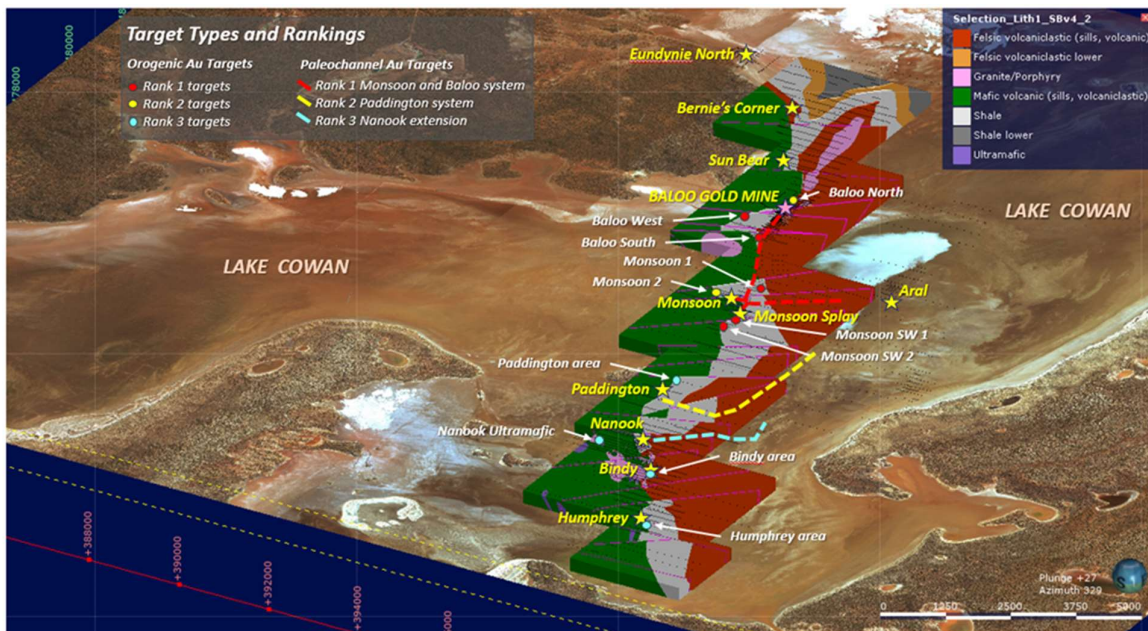

Figure 24-3 Sleuth Trend exploration targets identified by the CSA Global Study

Source: CSA Global (2021)



25 INTERPRETATION AND CONCLUSIONS

The Higginsville-Lakewood Operations marked a significant milestone in 2022 with the addition of the Lakewood Mill providing the combined capacity to treat 2.6 Mtpa of mill feed from both the Higginsville Gold Operation and Karora’s 100% owned Beta Hunt Operation. The continued growth of the Beta Hunt Gold Mineral Resources and the replacement of mine depleted Mineral Resources at HGO provide a strong foundation for ongoing investment in the Higginsville-Lakewood Operations.

Specific conclusions by area follow.

25.1 MINERAL RESOURCES

The future of the HLO is reliant on the ongoing replacement and growth of the Consolidated Mineral Resources from both the Beta Hunt Operation (BHO) and HGO Mineral Resources. This is highlighted by Karora’s production plan which has BHO supplying 2.0 Mtpa and HGO supplying 0.6 Mtpa as combined mill feed to the Higginsville-Lakewood Operations. The steady growth of Karora’s Mineral Resources provides confidence for ongoing investment in HLO. The updated Consolidated M&I Gold Mineral Resource totals 3.2 Moz, an increase of 9% over previously reported September 30, 2022 estimate for Beta Hunt (Karora, 2023b) and the previously reported January 2022 estimate for Higginsville (Karora, 2022). The Consolidated Inferred Gold Mineral Resource now totals 1.5 Moz, representing a 4% increase. The result continues the trend of increasing Mineral Resources (Figure 25-1) and provides the Company with the opportunity to develop medium- to long-term plans.

Figure 25-1 Consolidated Gold Mineral Resource timeline, 2016 to 2023

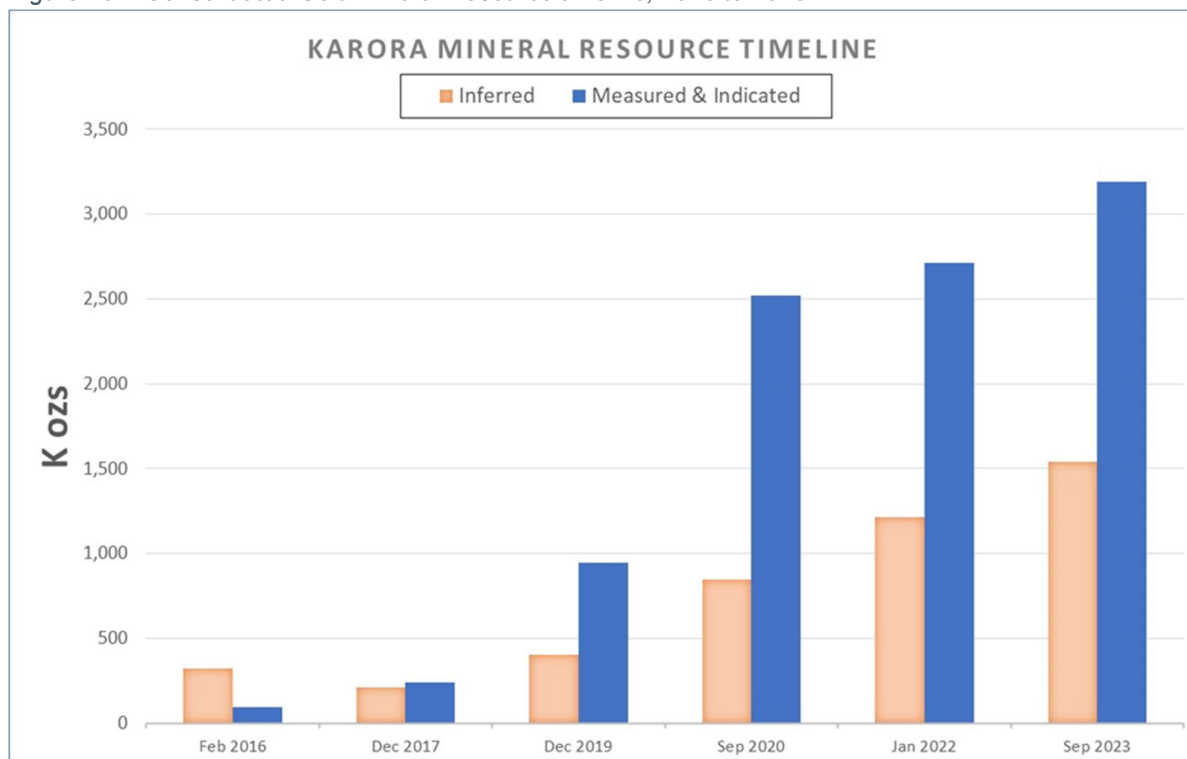

The property-wide exploration potential for both gold remains significant and is outlined in Section 24.

25.2 MINERAL RESERVES

The 2023 Mineral Reserve statement represents a 14% decrease in the Mineral Reserves over the previously reported September 2020 estimate for HLO with a majority of the decrease as a result of mining depletion at Baloo, Fairplay, Hidden Secret and Mouse Hollow. Wills and Louis deposits were re-evaluated with updated mining costs and found to be uneconomic and therefore removed from the Mineral Reserves.

The Gold Mineral Reserve provides a fundamentally strong basis for a robust future production profile. It is recommended that exploration and resource definition work at HLO is conducted with the aim of adding to the current Mineral Resource and Reserve base to offset mining depletion.

25.3 MINERAL PROCESSING

There is limited risk associated with the ongoing processing of mineralization at HLO:

- Beta Hunt has the proven ability to blend with mineralization from Karora's Higginsville Gold Operation which has, in some cases, resulted in improved throughputs and lowering overall milling costs.
- Beta Hunt and Higginsville mineralisation has shown to be readily amenable to the Higginsville and Lakewood Mills, achieving good recoveries and throughputs.

25.4 MINING

HLO's mine plan for 2024 is based on production from the Pioneer open pit and Two Boys underground mine, both currently active. The Spargos underground mine and the Musket deposit are scheduled to be in production in 2025.

It is recommended that required regulatory approvals are progressed to allow for the mining of the Mineral Reserves. HLO and Karora has a demonstrated history of gaining regulatory approvals in time to allow for mining and it can be reasonably expected that Karora will complete the work required to gain approvals prior to mining of the Mineral Reserves.

25.5 ENVIRONMENTAL

Karora maintains an Environmental Risk Register for both the Higginsville and Lakewood Mills. All high risk activities have associated risk mitigation and control measures to reduce the risks to an acceptable level. Management plans and/or procedures are developed and maintained to ensure the level of risk is managed at an acceptable level.

At Lakewood, water and tailings management are a key focus. Since the acquisition of Lakewood by Karora, considerable work has been undertaken to ensure compliance and risk mitigation by addressing all of the recommendations made by the geotechnical design engineer that included rock buttressing and sheet of TSF embankments. The Lakewood Mill is currently in compliance with environmental approvals, licences and permits.

In June 2023, Karora completed the third stage of a four-stage consolidation and lift program of its tailings storage facility (TSF 2–4) at Higginsville. Karora will begin construction on the fourth stage lift in Q4 2024. The remaining approved tailings storage capacity at TSF 2–4 is estimated to be approximately 30 months. Independent analysis and design were undertaken by Tetra Tech Coffey. Regulatory approvals have been received for all four stages. Karora are currently completing a feasibility study for the location of the next tailings storage facility.

25.6 CAPITAL REQUIREMENTS

The capital intensity for HLO is relatively low for the following reasons:

- The Higgsville Mill is fully functional requiring limited capital to maintain current production rates. Supporting capital requirements including an office and workshops, a 200 person accommodation village, and a fully stocked store including most critical spares are also in place.
- The Lakewood Mill plans to expand its production rate to 1.2 Mtpa in 2023. To achieve this target requires an appropriate increase in tailings storage capacity. The additional capacity will be met by undertaking two lifts on TSF 1 and completing the first stage of TSF 2. Funds of \$7.4M are allocated to do this work.

26 RECOMMENDATIONS

At HLO, the authors recommend that Karora use the recently defined Gold Mineral Reserve as the basis for providing medium- to long-term security for the ongoing development of HLO.

Specific recommendations include the following:

- Using the security of the Gold Mineral Reserve to develop medium- to long-term improvements in operational performance and costs, and also to provide leverage for capital investment if required.
- Complete a property-wide review of the Mineral Resources with the aim to prioritise extensional opportunities to support the combined mill capacity for future production.
- Realise the growth potential of the project by supporting exploration with sufficient funds to test high quality greenfields exploration targets.
- Progress regulatory approvals to allow the mining of the Mineral Reserve.

The authors are unaware of any other significant factors and risks that may affect access, title or the right or ability to perform the exploration work recommended for HLO.

27 REFERENCES

- Australian Bureau of Statistics, (2021) 2021 Census.
- Australasian Joint Ore Reserves Committee (JORC), (2012). *The Australasian Code for Reporting of Exploration Results, Mineral Resources and Ore Reserves* 2012 Edition. (the JORC Code).
- Avoca Resources Limited, (2006). *Feasibility Study for Higgsinsville Gold Project (Trident Underground)*. November, 2006.
- Avoca Resources Limited, (2010). *Feasibility Study for Chalice Gold Project*. July 2010. Internal Avoca report: unpublished.
- Avoca Resources Limited, (2011). *Mining Proposal for Chalice Underground Mine Part 1*. January 2011.
- Barnes, L. (2020). *Mineral Resources Review and Evaluation for the Nanook, Pluto and Wills Deposits*, Higgsinsville Gold Project Kambalda District, Western Australia. Trepanier Geology and Resource Consultants.
- Bewsher, A. (2013). *Panoramic Resources Limited Mount Henry Mineral Resource Report*, BMGS Perth, 10th July 2013.
- Botanica Consulting (for Karora Resources) (2023): *Lakewood Gold Processing Facility, Mining Proposal* Version 1.3 8 March 2023 Golden Mile Milling Environmental Group EGS Site Code: S0236118 L26/234, L26/293, M26/242, and M26/367. March, 2023.
- Buerger, R., Hingston, R., Sieradzki, J. & Turner, B. (2010). *Trident Resource Report*. Internal Avoca report: unpublished.
- Cassidy, KF, Champion, DC, Krapež, B, Barley, ME, Brown, SJA, Blewett, RS, Groenewald, PB and Tyler, IM. (2006). 'A revised geological framework for the Yilgarn Craton, Western Australia': *Geological Survey of Western Australia*, Record 2006/8.
- Canadian Institute of Mining, Metallurgy and Petroleum (CIM), (2014). *CIM Definition Standards for Mineral Resources & Mineral Reserves*. May 2014. (CIM Definition Standards).
- Clarke JD. (1993). 'Stratigraphy of the Lefroy and Cowan palaeodrainages'. Western Australia J D A Clarke: *Journal of the Royal Society of Western Australia*, 76: 13-23,1993
- Corin, Å., Stokes, C. & Sieradzki, J. (2014). *Chalice Identified Mineral Resource Estimate (JORC) as at 30th November 2014*. Metals X Limited.
- Cowan, M. (2001). *A Biodiversity Audit of Western Australia's 53 Biogeographic Subregions in 2002 – Section Coolgardie 3 (COO3- Eastern Goldfields Subregion)*. Available: https://www.dpaw.wa.gov.au/images/documents/about/science/projects/waaudit/coolgardie03_p156-169.pdf Prepared for the Department of Conservation and Land Management (now DBCA).
- CSA Global, Mining Industry Consultants (2021): *Integrated Geological Interpretation of the Sleuth Trend and Exploration Targeting, Higgsinsville, WA*, 17 September, 2021; CSA Global Report #: R375.2021

- Department of Mines, Industry Regulation and Safety and Department of Water and Environment Regulation (2021). *Administrative agreement*.
- Dubé, B. and Gosselin, P. (2007). *Greenstone-hosted quartz-carbonate vein deposits. Mineral Deposits of Canada: A synthesis of major deposit-types, district metallogeny, the evolution of geological provinces, and exploration methods*: Geological Association of Canada, Mineral Deposits Division, Special Publication, 5, pp.49-73.
- Gold Fields Limited, (2022). *Mineral Resources and Mineral Reserves Supplement to the Integrated Annual Report 2022*. www.goldfields.com/australia-region.php
- Griffin, T.J. (1990). *Geology of the granite-greenstone terrane of the Lake Lefroy and Cowan 1:100 000 sheets*, Western Australia, Western Australia. Department of Mines. GSWA
- Groundwater Development Services. (2015). *H1 Desktop Hydrogeological Assessment Mt Henry Open Pits October 2015*. Report for Metals X.
- Groundwater Development Services. (2016). *Hydrogeological Assessment Dewatering by Sumping Musket Project November 2016* . Report for Metals X.
- Hayman P.C., Thébaudc N., Pawleyd M.J., Barnese S.J., Cas R.A., Amelinf Y., Jyotindra Sapkotag J., Squire R.J. & Campbell I.H. (2015). 'Evolution of a ~2.7 Ga large igneous province: A volcanological, geochemical and geochronological study of the Agnew Greenstone Belt, and new regional correlations for the Kalgoorlie Terrane (YilgarnCraton, Western Australia)', *Precambrian Research* 270 (2015) 334-368
- Karora Resources Inc. (2020). Karora news release, August 7, 2020.
- Karora Resources Inc. (2021a). *NI 43-101 Technical Report*, January 29, 2021. www.sedar.com
- Karora Resources Inc. (2021b). Karora news release, March 1, 2021.
- Karora Resources Inc. (2021c). Karora news release, September 14, 2021.
- Karora Resources Inc. (2022). Karora news release, April 7, 2022.
- Karora Resources Inc. (2023). *Higginsville Gold Operations - Pioneer Gold Project Mining Proposal*, February 6, 2023.
- Karora Resources Inc. (2023b). Karora news release, February 13, 2023.
- Karora Resource Inc. (2023c). Karora news release, September 18, 2023.
- LBC Resources. (2006). *Resource Estimation Report for the Mitchell Deposit, Challenge Area, Higginsville Project, Western Australia*. Prepared for Avoca Resources.
- Le Brun, S. (2009). *Resource Estimate Report for the Musket Gold deposit*, (2009a) Zuleika Shear south project, Western Australia. Avoca Resources. unpublished.
- Lintern, MJ, Craig MA, Walsh DM, & Sheridan NC. (2001). *The distribution of Gold and Other Elements in Surficial Material from the Higginsville Palaeochannel Gold Deposits, Norseman, Western Australia*. CRC LEME Open file Report 102
- McEwen, G. (2000). *Annual Report Mitchell Project Mining Leases M15/640, M15/641. For the period 25 January 1999 to 24 January 2000*, Resolute Limited. October 2000. Report No M3625/1. WAMEX Report No: A61604.

- Mesiha, J & McGoldrick, K. (2014). *Chalice Mine Closure Report*. Internal Metals X report: unpublished.
- Metals X. (2016). *Mining Proposal for Lake Cowan, Part 4, May 2016*.
- Model Earth (2021a). *Higginsville Project. Line of Lode: Geological Review*, February – March, 2021. Ben McCormack and Clemens Augenstein.
- Model Earth (2021b). *Spargo's Deposit Geology*. Report for Karora Resources, August 2021. Ben McCormack and Francois Voute.
- Peter O'Bryan & Associates. (2015). *Mt Henry Gold Project Open Pit Design Review No.2*. April 2015.
- Poulsen, K.H., Robert, F., and Dubé, B. (2000). *Geological classification of Canadian gold deposits*: Geological Survey of Canada, Bulletin 540, 106p.
- Resource Engineering Consultants. (2020) *Preliminary Geotechnical Assessment Spargos Reward Deposit*. Report for Karora Resources, November 2020.
- Rockwater. (2018) *Mitchell Pits, Higginsville Hydrology and Surface Water Management Plan*. Report for Westgold Resources, August 2018.
- Rockwater. (2019) *Hydrogeological Assessment for Amendment of GWL160795 and Use of Aphrodite and Mitchell Pits for Tailings Storage*. Report for Westgold Resources, January 2019.
- Rockwater. (2019) *Pioneer Gold Deposit Results of Permiability Tests and Groundwater Modelling*. Report for Westgold Resources, May 2019.
- Rockwater. (2022) *Spargos Pit Stage 2 Dewatering Assessment*. Report for Karora Resources.
- S&P Capital IQ. Capital IQ - S&P Global Market Intelligence, a division of S&P Global Inc. (company subscription).
- Sieradzki, J. (2017). Westgold Group *Trident Identified Mineral Resource Estimate as at 31st March 2017*. Westgold Resources Limited.
- SRK Consulting (Australasia) Pty Ltd (SRK), (2010). *NI 43-101 Technical Report of the Mining Operations and Exploration Tenements of Avoca Resources Limited Western Australia*. Prepared for Anatolia Minerals Development Ltd.
- SRK Consulting (Australasia) Pty Ltd (SRK), (2018). *Selene Pits – Water Management Concept*. Prepared for Westgold Resources Limited, February 2018.
- Stanley, J. (2014). *Wills Identified Mineral Resource (JORC)*. Metals X Limited.
- Stedman, A. & Green, K.P. (2018). *Fraser Institute Annual Survey of Mining Companies 2018*. Fraser Institute. <<http://www.fraserinstitute.org>>.
- Swager, CP. (1989). *Structure of the Kalgoorlie greenstones — regional deformational history and implications for the structural setting of gold deposits within the Golden Mile*: Geological Survey of Western Australia, Report 25, p. 59–84.
- Tetra Tech Coffey (TTC), (2021). *Hydrological Assessment and Surface Water Management*. Prepared for Golden Mile Milling Pty Ltd and the DMIRS

Tille, P. (2006). *Soil Landscapes of Western Australia's Rangelands and Arid Interior*. Department of Primary Industries and Regional Development, Western Australia, Perth. Report 313.

Westgold Resources Limited. (2017a). *Mining Proposal for Musket Project, Part 1, Revision 1 Higgsville Gold Operations*. January 2017.

Westgold Resources Limited. (2017b). *Higgsville Gold Operations Annual Mineral Resource Commentary, June 2017*. Westgold Resources Limited.

Westgold Resources Limited. (2018). *Fairplay, Fairplay East and Fairplay North deposits - Identified Mineral Resource Estimate (JORC) as at 31st of March 2018*. Westgold Resources Limited.

Westgold Resources Limited. (2019). (*mt_henry_gcx_master_depleted_20190331_v2.mdl*) Identified Mineral Resource Estimate (JORC) as at 31st March 2019.

World Gold Council: www.gold.org

APPENDIX 1 DEFINITIONS

All currency amounts are stated in either Australian dollars (A\$ or AUD), Canadian dollars (C\$) or US dollars (USD or US\$). The choice of currency reflects the underlying currency for an item, for example:

Capital and operating costs are expressed in A\$ as this is the currency in use at site. Moreover, the size of the Australian economy is such that these costs are relatively insensitive to variation in the A\$ - US\$ exchange rate.

As is the common global practice, commodity prices in this Technical Report are generally expressed in US\$. Nickel prices are also reported in A\$ as this is the contractual basis for one of the royalties.

Valuations are expressed in US\$ to reflect both the global nature of the investment community and the linkage between valuation and commodity price.

Quantities are generally stated using the Système International d'Unités (SI) or metric units, the standard Canadian and international practice, including metric tonnes (t), kilograms (kg) or grams (g) for weight, kilometres (km) or metres (m) for distance and hectares (ha) for area. Wherever applicable, imperial units have been converted to SI units for reporting consistency.

Frequently used acronyms and abbreviations are listed below.

ABGM PTY LTD	ABGM
<i>Aboriginal Heritage Act 1972 (WA)</i>	AHA
Aboriginal Heritage Inquiry System	AHIS
Aircore	AC
Alacer Gold Corp.	Alacer
Anatolia Minerals Development Limited	Anatolia
Annum (year)	a
Atomic Absorption Spectroscopy	AAS
'Australasian Code for Reporting of Mineral Resources and Ore Reserves' 2012 Edition prepared by the Joint Ore Reserves Committee of the Australasian Institute of Mining and Metallurgy, Australian Institute of Geoscientists and Mineral Council of Australia	JORC Code
Australian Height Datum	AHD
Australian Securities Exchange	ASX
Avoca Resources Pty Ltd (previously Avoca Resources Limited)	Avoca
Avoca Mining Pty Ltd	AML
Banded Iron Formation	BIF
Bank cubic metre	bcm
Base of alluvial	BOA
Base of complete oxidation	BOCO
Beta Hunt Mine	Beta Hunt
Beta Hunt Operations	BHO
BHP Billiton Nickel West Pty Ltd	BHP
Bureau Veritas	BV
Calendar year	CY
Canadian Securities Administrators	CSA
Carbon-in-leach	CIL
Centimetre	cm
Certified reference material	CRM

Coefficient of variation	CV
Commonwealth of Australia	Cth
Consolidated Nickel Kambalda Operations Pty Ltd.	CNKO
Cubic metre	m ³
Degree	°
Degrees Celsius	°C
Department of Biodiversity, Conservation and Attractions	DBCA
Department of Climate Change, Energy, the Environment and Water	DCCEEW
Department of Water and Environment Regulation, amalgamation of previous government bodies: Department of Environmental Regulation and Department of Water	DWER, DoW, or DER
Department of Mines, Industry Regulation and Safety	DMIRS, DMP
Department of Planning Lands and Heritage	DPLH
Department of Water	DoW
Digital terrain model	DTM
Downhole	DH
Effective grinding length	EGL
Electromagnetic	EM
End of hole	EOH
End of mine	EOM
<i>Environmental Protection Act 1986</i>	EP Act
Environmental Protection Authority	EPA
Estimated true width	ETW
Fly-in/fly-out	FIFO
Footwall	
Front end loader	FEL
General and administrative	G&A
Geological Database Management System	GDMS
Gold	Au
Gold Fields Limited	Gold Fields
Golden Mile Milling Pty Ltd	GMM
Grade control	GC
Gram	g
Grams per litre	g/L
Grams per tonne	g/t
Greater than	>
Greenstone-hosted quartz-carbonate vein	GQC
Hangingwall	HW
Hectare (10,000 m ²)	ha
Higginsville Gold Operations	HGO
Higginsville-Lakewood Operations	HLO
High grade	HG
Hour	h
Inductively coupled plasma	ICP
Inductively coupled plasma atomic emission spectroscopy	ICP-AES
Inductively coupled plasma mass spectrometry	ICP-MS
Inductively coupled plasma optical emission spectroscopy	ICP-OES
Interim Biogeographic Regionalisation for Australia	IBRA
Inverse distance	ID
Inverse distance squared	ID ²
Inverse distance cubed	ID ³
Joint Ore Reserves Committee	JORC
Kalgoorlie Consolidated Gold Mines	KCGM

Kalgoorlie Nickel Smelter	KNS
Kambalda Nickel Concentrator	KNC
Karora Resources Inc.	Karora
Kilogram	kg
Kilometre	km
Kilovolts	kV
Kilowatt hour	kWh
Kilowatt	kW
Kriging neighbourhood analysis	KNA
Lakewood Operations	LKO
Less than	<
Life of mine	LOM
Line-of-lode	LOL
Liquified natural gas	LNG
Litre	L
Litres per second	L/s
Load-haul-dump	LHD
Longhole open stoping	LHOS
Low grade	LG
Maxwell Data Model	MDM
Metals X Limited	Metals X
Metre	m
Metres above sea level	masl
Metres reduced level	mRL
Micrometre (micron)	µm
Milligal; unit of acceleration typically used in precision gravimetry	mgal
Millimetre	mm
Million	M
Million troy ounces	Moz
Million pounds	Mlbs
Million pounds per annum	Mlbs/a
Million tonnes per annum	Mtpa
Million years	Ma
Mine Closure Plan	MCP
Mineable Shape Optimizer	MSO
Mineral Titles Online	MTO
Minimum design width	MDW
Minimum mining width	MMW
<i>Mining Act 1978 (WA)</i>	Mining Act
Mining Proposal	MP
Mining Rehabilitation Fund	MRF
<i>Mining Rehabilitation Fund Act 2012 (WA)</i>	<i>MRF Act</i>
Minute (plane angle)	'
Minute	min
Mt Henry Project	MHP
National Instrument 43-101	NI 43-101
<i>Native Title Act 1993 (Cth)</i>	NTA
Ngadju Native Title Aboriginal Corporation	Ngadju
Not applicable	N/A
Notice of Intent	NOI
Ordinary kriging	OK
Orelogy Mine Consulting Pty Ltd	Orelogy
Panoramic Resources Ltd	Panoramic

Parts per billion	ppb
Parts per million	ppm
Percent	%
Polar Metals Pty Ltd	PMT
Portable X-ray fluorescence	pXRF
Poseidon South Pit	PSP
Poseidon South Underground	PSU
Pound(s)	lb(s)
Power Purchase Agreement	PPA
Preliminary economic assessment	PEA
Prefeasibility study	PFS
Proven and Probable	2P
Qualified Person	QP
Quality Assurance and Quality Control	QA/QC
Real-time kinematic	RTK
Reasonable prospects for eventual economic extraction	RPEEE
Reduced level	RL
Reliance Mining Limited	RML
Resolute Mining Limited	Resolute
Return air rise	RAR
Reverse circulation	RC
Reverse circulation/diamond tail	RCD
RNC Minerals	RNC
Rock Quality Designation	RQD
Rotary airblast	RAB
Run of mine	ROM
S2 Resources Limited	S2
Salt Lake Mining Pty Limited	SLM
Samantha Gold NL	Samantha
Second (plane angle)	
Selective mining unit	SMU
Specific gravity	SG
Square kilometre	km ²
Square metre	m ²
St Ives Gold Mining Company Pty Limited	SIGMC
System for Electronic Document Analysis and Retrieval	SEDAR
Tailings storage facility	TSF
Tetra Tech Coffey	TTC
Thousand tonne	kt
Thousand tonne per day	kt/d
Thousand troy ounces	koz
Top of fresh rock	TOFR
Tonne (1,000 kg)	t
Tonnes per day	t/d
Tonnes per hour	t/h
Tonnes per year	tpa
Total dissolved solids	TDS
Troy ounce (31.10348 grams)	oz
Two Boy Shear Zone	TBSZ
Unconfined compressive strength	UCS
Underground	UG
Waste rock landform	WRL
Westgold Resources Limited	Westgold



Western Australia
Western Mining Corporation

WA
WMC

CERTIFICATE OF QUALIFIED PERSON

Stephen Devlin

Karora Resources Inc
Ground Floor, 15 Altona St
West Perth WA 6005, Australia
Telephone: +61 (0)427 778 299
Email: steve.devlin@karoraresources.com

To accompany the Technical Report titled: 'Higginsville-Lakewood Operation Eastern Goldfields, Western Australia' dated January 4, 2024.

I, Stephen Devlin, BSc, FAusIMM, do hereby certify that:

1. I am Chief Geological Officer at Karora Resources Inc, with an office at 15 Altona St, West Perth, Western Australia, Australia.
2. I am a graduate from Sydney University, NSW Australia in 1980 with a B.Sc. Hons in Geology and from Curtin University, Perth, Western Australia in 2013 with a Grad. Certificate in Mineral & Energy Economics; and I have practised my profession continuously since 1981. My relevant experience for the purpose of the Technical Report is: Over 30 years of gold industry experience in exploration, resource development, resource estimation/auditing, mining and management of gold and nickel deposits in the Archean of Western Australia.
3. I am a Fellow of the Australasian Institute of Mining and Metallurgy.
4. I have read the definition of 'Qualified Person' set out in National Instrument 43-101 (NI 43-101) and certify that by reason of my education, affiliation with a professional association (as defined in NI 43-101) and past relevant work experience, I fulfil the requirements to be a 'Qualified Person' for the purposes of NI 43-101.
5. I have prior involvement with the properties that are the subject of the Report. This involvement is via my role as Group Geologist and, later as Chief Geological Officer with Karora Resources Inc. between January 2019 and present, as well as fulfilling the role of Business Development Manager with Salt Lake Mining Pty Ltd and Royal Nickel Corporation (prior owners of the Beta Hunt Mine) between 2014 and 2018.
6. I am responsible for the following sections in the Technical Report entitled 'Higginsville-Lakewood Operation Eastern Goldfields, Western Australia' dated January 4, 2024: 1, 2,3, 4, 5 6, 7, 8, 9, 10, 11, 12, 14 (except 14.4.6), 19, 20, 22, 23, 24, 25, 26, and 27.
7. I am not an independent 'qualified person' within the meaning of section 1.5 of National Instrument 43-101 – Standards of Disclosure for Mineral Projects of the Canadian Securities Administrators.
8. I have read NI 43-101 and Form 43-101F1 and have prepared and read the previously-mentioned section of the report entitled 'Higginsville-Lakewood Operation Eastern Goldfields, Western Australia' dated January 4, 2024 for Karora Resources Inc, in compliance with NI 43-101 and Form 43-101F1.
9. That, at the effective date of this technical report September 30, 2023 to the best of my knowledge, information, and belief it contains all scientific and technical information that is required to be disclosed to make the technical report not misleading.

This 4th day of January 2024

Original Signed



Steve Devlin

CERTIFICATE OF QUALIFIED PERSON

Peter Ganza

Karora Resources Inc
Ground Floor, 15 Altona St
West Perth WA 6005, Australia
Telephone: +61 (0)432 874 710
Email: peter.ganza@karoraresources.com

To accompany the Technical Report titled: 'Higginsville-Lakewood Operation Eastern Goldfields, Western Australia' dated January 4, 2024.

I, Peter Ganza, BEng , MAusIMM(CP), do hereby certify that:

1. I am Chief Operating Officer - Australia at Karora Resources Inc, with an office at 15 Altona St, West Perth, Western Australia, Australia.
2. I am a graduate from University of Queensland, QLD Australia in 1993; and I have practised my profession continuously since 1994. My relevant experience for the purpose of the Technical Report is: 30 years of gold and base metals industry experience in feasibility studies, operational mine start-up and closure, mine costings, steady state mine operation and management.
3. I am a Chartered Professional Member of the Australasian Institute of Mining and Metallurgy.
4. I have read the definition of 'Qualified Person' set out in National Instrument 43- 101 (NI 43-101) and certify that by reason of my education, affiliation with a professional association (as defined in NI 43-101) and past relevant work experience, I fulfil the requirements to be a 'Qualified Person' for the purposes of NI 43-101.
5. I have prior involvement with the properties that are the subject of the Report. This involvement is via my role as Group Manager Technical Services from May 2023 and Chief Operating from October 2023.
6. I am responsible for the following sections in the Technical Report entitled 'Higginsville-Lakewood Operation Eastern Goldfields, Western Australia' dated January 4, 2024: 13, 15, 16, 17, 18 and 21.
7. I am not an independent 'qualified person' within the meaning of section 1.5 of National Instrument 43-101 – Standards of Disclosure for Mineral Projects of the Canadian Securities Administrators.
8. I have read NI 43-101 and Form 43-101F1 and have prepared and read the previously-mentioned section of the report entitled 'Higginsville-Lakewood Operation Eastern Goldfields, Western Australia' dated January 4, 2024 for Karora Resources Inc, in compliance with NI 43-101 and Form 43-101F1.
9. That, at the effective date of this technical report December 30, 2023, to the best of my knowledge, information, and belief it contains all scientific and technical information that is required to be disclosed to make the technical report not misleading.

This 4th day of January 2024

Original Signed



Peter Ganza

CERTIFICATE OF QUALIFIED PERSON

Ian Glacken

Snowden Optiro

L19, 140 St Georges Terrace, Perth, WA 6000, Australia

Telephone: +61 408 949 583

Email: ian.glacken@snowdenoptiro.com

To accompany the Technical Report titled: "Higginsville-Lakewood Operation, Eastern Goldfields, Western Australia" dated January 4, 2024.

I, Ian Glacken, BSc, MSc (Min. Geol), MSc (Geostatistics), DIC, FAusIMM(CP), FAIG, MIMMM, CEng, do hereby certify that:

1. I am an Executive Consultant at Snowden Optiro, a minerals industry advisory organisation based in Perth, Western Australia. Snowden Optiro is a wholly owned subsidiary of Datamine Australia.
2. I am a graduate of Durham University, United Kingdom, in 1979, with a BSc (honours) in geology, of the Royal School of Mines, United Kingdom, in 1981 with an MSc in Mining Geology and of Stanford University, USA, in 1996 with an MSc in Geostatistics. I have practised my profession continuously since 1981. For the purposes of the Technical Report, I have over 40 years experience in the minerals industry worldwide, with a heavy emphasis on gold, focussing on mining geology, geological management, Mineral Resource estimation, substantially in the Archaean of the Eastern Gold Fields of Western Australia.
3. I am a Fellow of the Australasian Institute of Mining and Metallurgy, of the Australian Institute of Geoscientists, a Member of the Institution of Materials, Mining and Metallurgy (United Kingdom) and a Chartered Engineer of that organisation.
4. I have read the definition of "Qualified Person" set out in National Instrument 43-101 (NI 43-101) and certify that by reason of my education, affiliation with a professional association (as defined in NI 43-101) and past relevant work experience, I fulfil the requirements to be a "Qualified Person" for the purposes of NI 43-101.
5. I have had prior involvement with some of the properties that are the subject of the Technical Report, including those for which I am taking responsibility. This includes a review of the Mt Henry deposits, incorporating a site visit to the Mt Henry mine in February 2019.
6. I am responsible for Section 14.4.6 of the Technical Report entitled "Higginsville-Lakewood Operation, Eastern Goldfields, Western Australia" dated January 4, 2024, specifically the description of the Mineral Resources of the Mt Henry area.
7. I fulfil the definition of an independent Qualified Person within the meaning of section 1.6 of National Instrument 43-101 – Standards of Disclosure for Mineral Projects of the Canadian Securities Administrators.
8. I have read NI 43-101 and Form 43-101 F1 and have prepared and read the previously-mentioned section of the Technical Report entitled "Higginsville-Lakewood Operation Eastern Goldfields, Western Australia" dated January 4, 2024 for Karora Resources Inc, in compliance with NI 43-101 and Form 43-101F1.
9. That, at the effective date of this Technical Report September 30, 2023, to the best of my knowledge, information, and belief it contains all scientific and technical information that is required to be disclosed to make the Technical Report not misleading.

This 4th day of January 2024

Original Signed

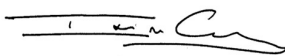

Ian M Glacken